

ULINE H-1022

HEAVY DUTY ECONOMY PLASTIC PALLET

1-800-295-5510
 uline.com

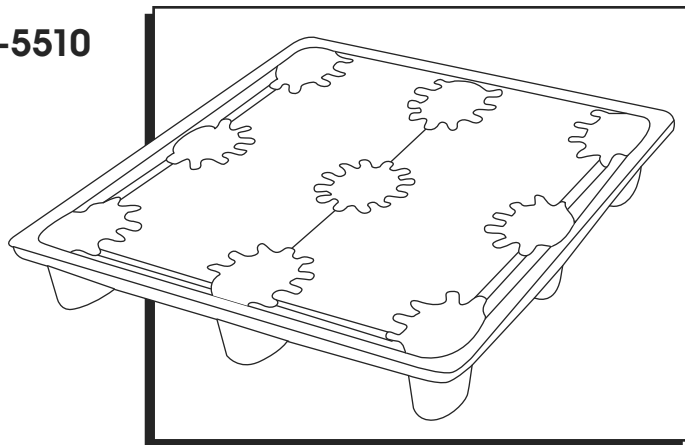

DIMENSIONS

LOAD CAPACITY

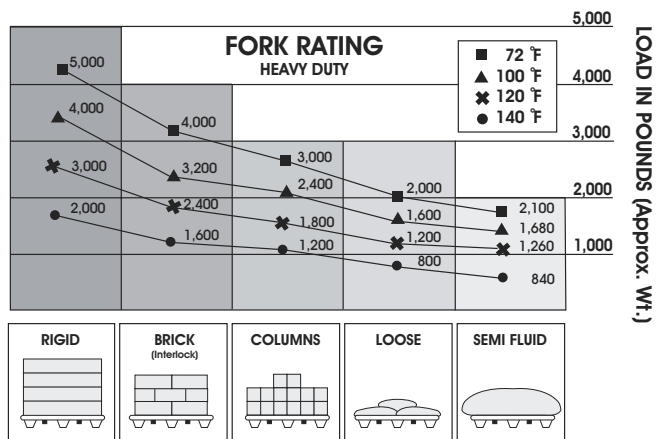

TOP VIEW

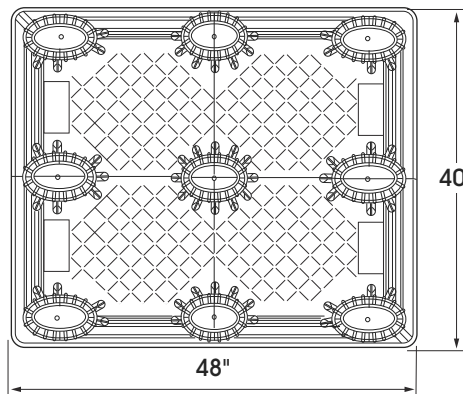

SHORT SIDE VIEW

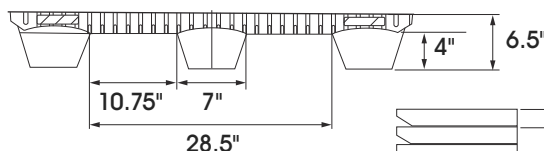
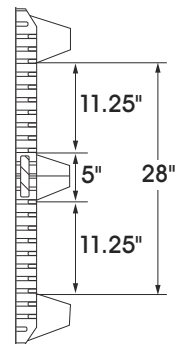

LONG SIDE VIEW



STACKING METHOD



NOTE: Fork rating differs with stacking method and facility's temperature. Consider this factor as it relates to your application.

SPECIFICATIONS

MODEL #	DIMENSIONS		HEIGHT		NESTED TRAILER		WEIGHT CAPACITY		WEIGHT	
	L	W	FORK	OVERALL	NESTING	48'	53'	FLOOR		FORK
H-1022	48"	40"	4"	6.5"	2.5"	1,008	1,080	6,500 lbs.	3,000 lbs.	21 lbs.

ULINE H-1022

**TARIMA DE PLÁSTICO
ECONÓMICA PARA
USO PESADO**

800-295-5510
uline.mx

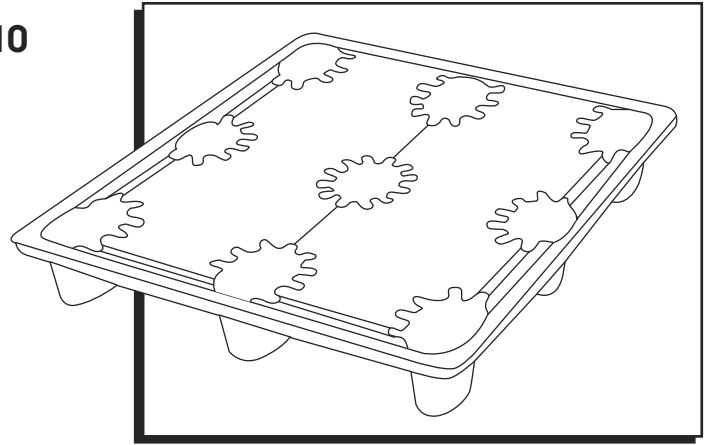

DIMENSIONES

CAPACIDAD DE CARGA

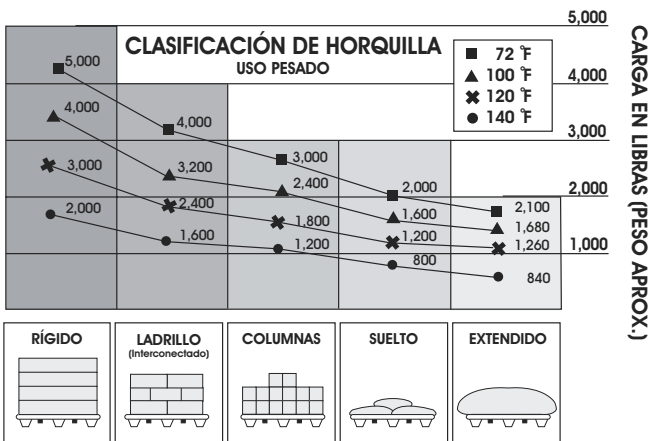

MÉTODO DE ESTABILICIÓN

NOTA: La clasificación de horquilla difiere con el método de estabilización y la temperatura de las instalaciones. Considere este factor conforme se relacione con su aplicación.

VISTA SUPERIOR

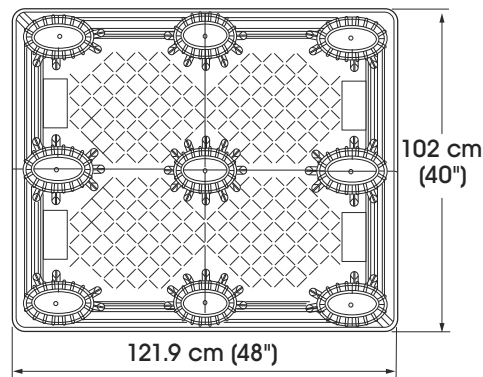

VISTA DEL LADO CORTO

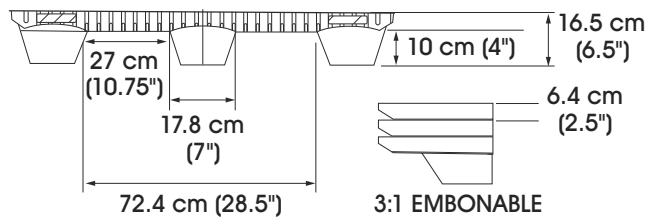
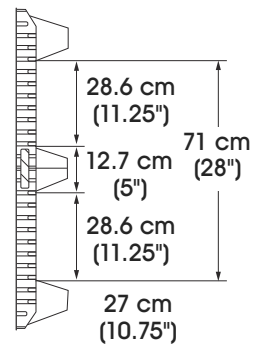

VISTA DEL LADO LARGO

3:1 EMBONABLE
PLÁSTICO:MADERA

ESPECIFICACIONES

MODELO NO.	DIMENSIONES		ALTURA			EMBOBADAS EN TRÁILER		CAPACIDAD DE PESO		PESO
	LARGO	ANCHO	HORQUILLA	TOTAL	EMBOBADABLE	14.6 m (48')	16.15 m (53')	PISO	HORQUILLA	
H-1022	121.9 cm (48")	102 cm (40")	10 cm (4")	16.5 cm (6.5")	6.4 cm (2.5")	1,008	1,080	2,948 kg (6,500 lbs.)	1,360 kg (3,000 lbs.)	9.5 kg (21 lbs.)

ULINE H-1022

**PALETTE EN PLASTIQUE
ÉCONOMIQUE
ET ROBUSTE**

1-800-295-5510
uline.ca

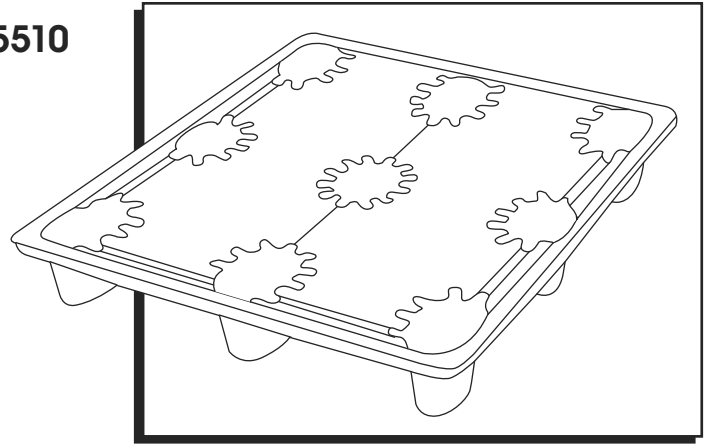

DIMENSIONS

CAPACITÉ DE CHARGEMENT

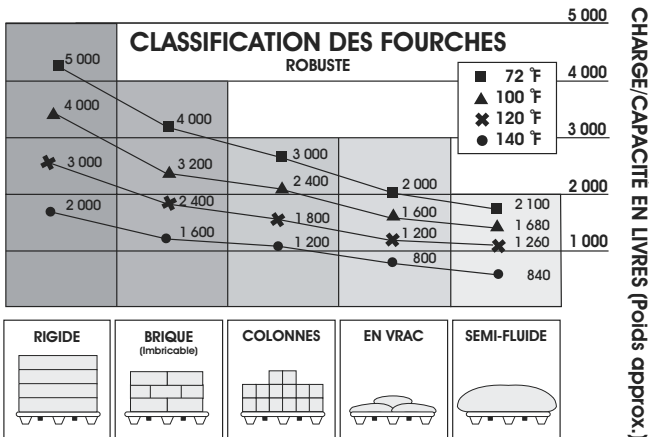

MÉTHODE D'EMPILAGE



REMARQUE: La classification des fourches varie selon la méthode d'empilage et la température de l'établissement. Prenez ce facteur en considération lors de l'utilisation.

VUE DE DESSUS

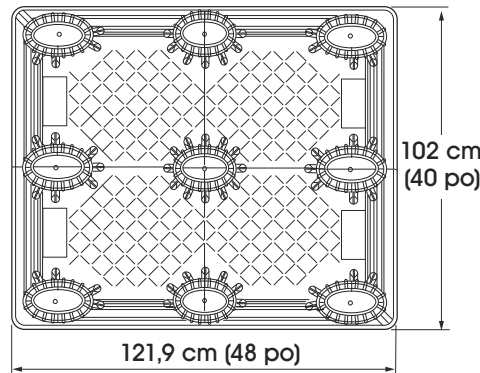

VUE DU CÔTÉ COURT

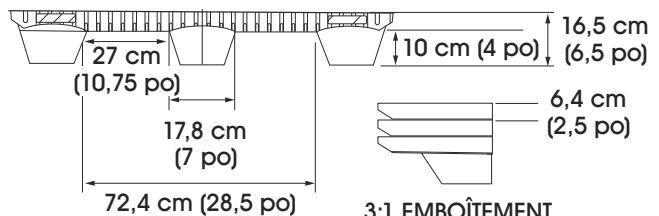
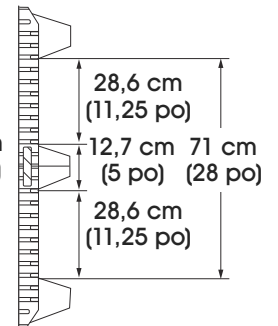

VUE DU CÔTÉ LONG

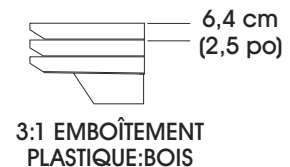

SPÉCIFICATIONS

N° DE MODÈLE	DIMENSIONS		HAUTEUR			REMORQUE EMBOÛTÉE		CAPACITÉ PONDÉRALE		POIDS
	LONG.	LARG.	FOURCHE	TOTALE	EMBOÛTEMENT	14,6 m (48 pi)	16,15 m (53 pi)	PLANCHER	FOURCHE	
H-1022	121,9 cm (48 po)	102 cm (40 po)	10 cm (4 po)	16,5 cm (6,5 po)	6,4 cm (2,5 po)	1 008	1 080	2 948 kg (6 500 lb)	1 360 kg (3 000 lb)	9,5 kg (21 lb)