

ULINE H-10751, H-10752 CLEANROOM GOWNING BENCH

1-800-295-5510
uline.com

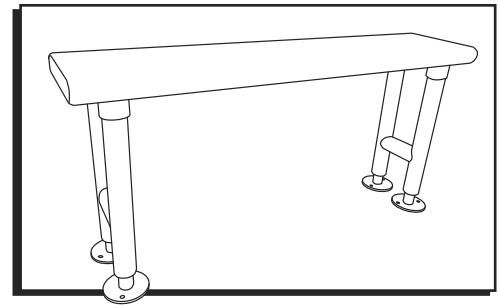

TOOLS NEEDED



Drill



1/2" Masonry Drill Bit

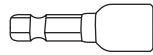

14 mm Nut Driver Bit

PARTS



Bench Top x 1

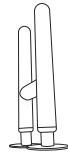

Leg x 2



Set Screw x 8

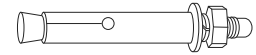

Anchor Hardware Set x 8
(Anchor Bolt, Anchor Sleeve, Washer,
Lock Washer and Nut)

ASSEMBLY

1. Lay bench top on a smooth, non-marring surface with leg mounts face up. Align legs with leg mounts on bench top. (See Figure 1)

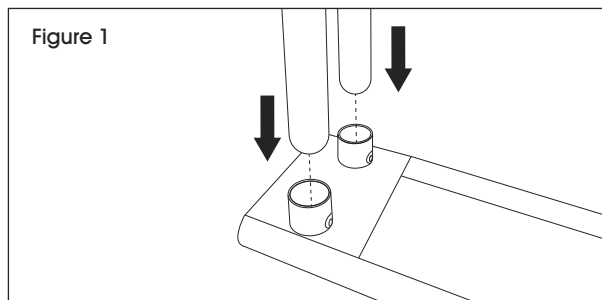

2. Secure legs to bench top with set screws. Repeat for remaining leg. (See Figures 1-2)

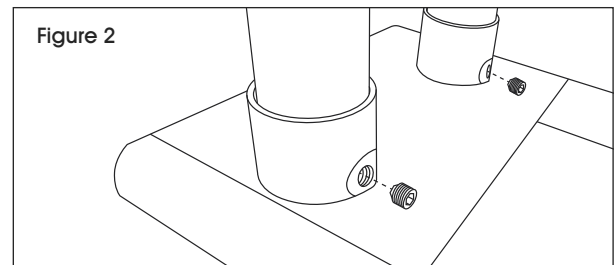

CONCRETE ANCHORING

1. Position bench at desired location. Using pre-drilled holes in leg bases as templates, mark each hole location.
2. Using a 1/2" masonry drill bit, drill holes at all marked locations approximately 2" deep.
3. Insert anchor bolt and sleeve into hole. Ensure sleeve is flush with floor and bolt threads are above floor level. Repeat for remaining anchors.
4. Align holes in leg base with anchors in concrete. Place washer and nut onto threaded portion of anchor bolt. Tighten using Drill and 14mm nut driver bit. Repeat for remaining holes. (See Figure 3)

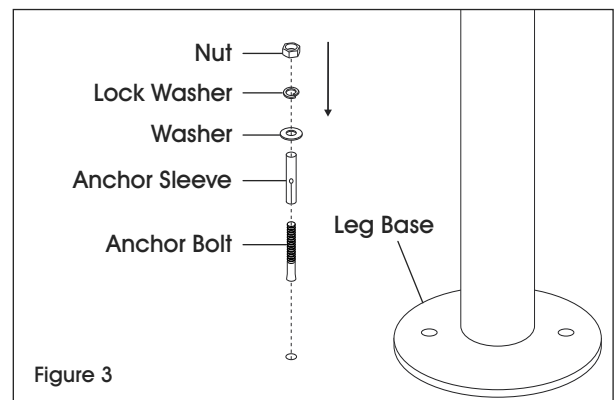

ULINE H-10751, H-10752

BANCA PARA CUARTO LIMPIO

800-295-5510

uline.mx

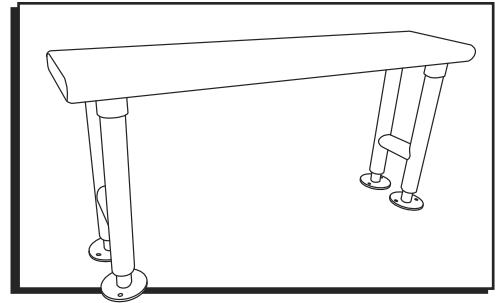

HERRAMIENTAS NECESARIAS



Taladro



Broca de Mampostería de 1/2"

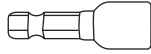

Punta de Desarmador para Tuerca de 14 mm

PARTES



1 Cubierta de Mesa

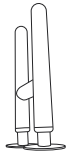

2 Patas



8 Tornillos de Ajuste

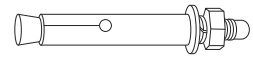

8 Sets de Tornillería para Anclaje (Perno de Anclaje, Taquete de Anclaje, Rondana, Rondana de Seguridad y Tuerca)

ENSAMBLE

1. Coloque la banca sobre una superficie lisa que no deje marcas, con las bases de instalación de las patas hacia arriba. Alinee las patas con las bases de instalación en la cubierta de la banca. (Vea Diagrama 1)

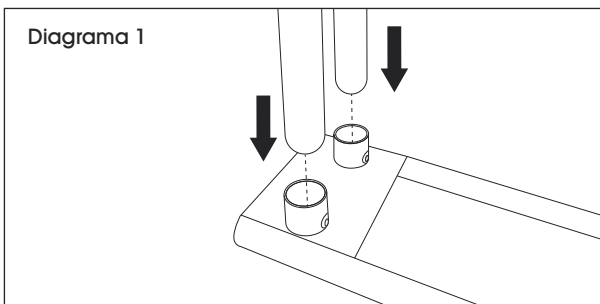

2. Asegure la pata a la cubierta de la banca con tornillos de ajuste. Repita para la pata restante. (Vea Diagramas 1-2)

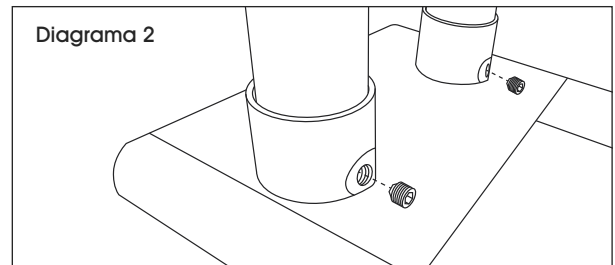

ANCLAJE PARA CONCRETO

1. Coloque la banca en la ubicación deseada. Utilizando como plantilla los orificios preperforados de la bases para patas, marque cada ubicación de orificio.
2. Usando una broca de mampostería de 1/2" de diámetro, haga un orificio de aproximadamente 2" de profundidad en cada ubicación marcada.
3. Inserte el perno y el taquete de anclaje en el orificio. Asegúrese de que el taquete quede a ras y la porción con rosca del perno de anclaje por encima del nivel del piso. Repita la operación con los anclajes restantes.
4. Alinee los orificios de la base de las patas con los taquetes en el concreto. Coloque la rondana y la tuerca en la porción con rosca del perno de anclaje. Apriete usando el taladro y la punta de desarmador para tuerca de 14 mm. Repita para los orificios restantes. (Vea Diagrama 3)

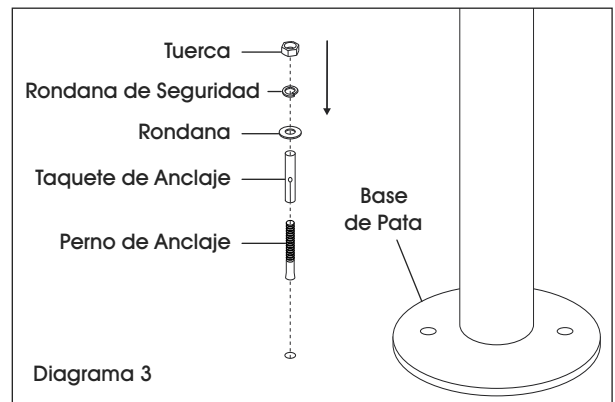

ULINE H-10751, H-10752

BANC D'HABILLAGE POUR SALLE BLANCHE

1-800-295-5510
uline.ca

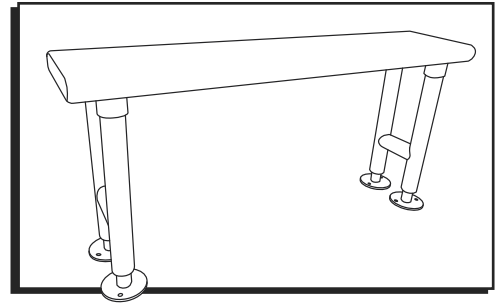

OUTILS REQUIS

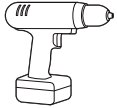

Perceuse



Mèche à maçonnerie de 1/2 po

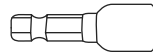

Embout de tourne-écrous de 14 mm

PIÈCES

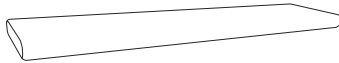

Dessus de banc x 1

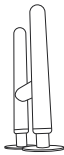

Pied x 2



Vis de réglage x 8

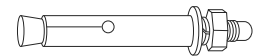

Ensemble de matériel d'ancrage x 8 (boulon d'ancrage, douille d'ancrage, rondelle, rondelle de blocage et écrou)

MONTAGE

- Placez le dessus de banc sur une surface lisse et qui ne raye pas avec les fixations des pieds vers le haut. Alignez les pieds sur les fixations des pieds du dessus de banc. (Voir Figure 1)

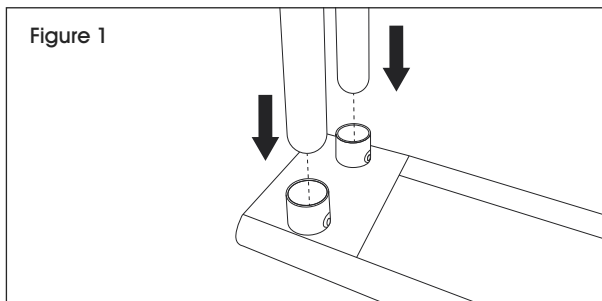

- Fixez le pied au dessus de banc avec des vis de réglage. Répétez l'opération pour l'autre pied. (Voir Figures 1 et 2)

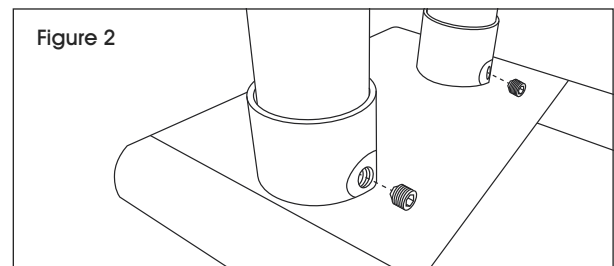

ANCRAGE POUR BÉTON

- Placez le banc à l'endroit souhaité. En utilisant les trous prépercés dans les bases de pied comme modèles, marquez l'emplacement de chaque trou.
- Percez des trous de 2 po de profondeur environ avec une mèche à maçonnerie de 1/2 po à tous les emplacements marqués.
- Insérez un boulon d'ancrage et une douille d'ancrage dans un des trous. Assurez-vous que la douille est au niveau du sol et que les filetages des boulons sont au-dessus du niveau du sol. Répétez l'opération pour les autres ancrages.
- Alignez les trous de la base de pied sur les ancrages dans le béton. Placez une rondelle et un écrou sur la partie filetée du boulon d'ancrage. Serrez avec la perceuse et l'embout de tourne-écrous de 14 mm. Répétez l'opération pour les autres trous. (Voir Figure 3)

