



H-11137, H-11138
H-11139

METRO BAR HEIGHT TABLE

1-800-295-5510
uline.com

TOOLS NEEDED



5 mm Allen Wrench
4 mm Allen Wrench
(included)



Two Person Assembly
Recommended

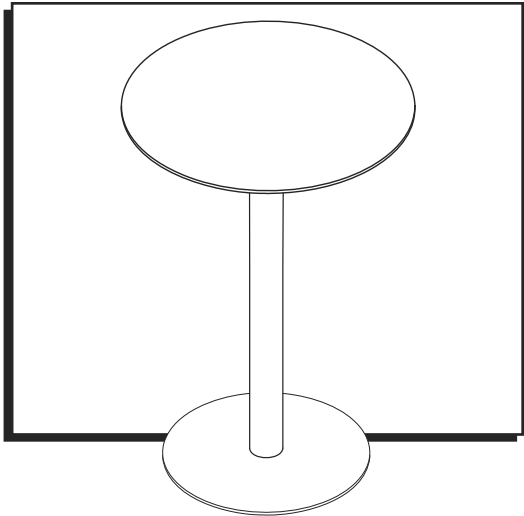

PARTS

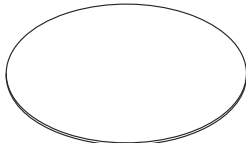

Round Tabletop x 1

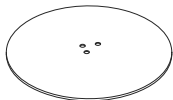

Base x 1

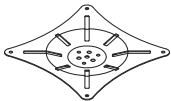

Top Plate x 1



Column x 1

Hardware Kit

A		B	
	M8 x 30 mm Flat Head Bolt x 3		M8 x 30 mm Round Head Bolt x 3
C			
	M6 x 15 mm Bolt x 4		

ASSEMBLY



NOTE: Assemble unit on a smooth, non-marring surface to prevent scratching.

- Check that all parts are included.

1. Connect base to column using three M8 x 30 mm flat head bolts (A). Tighten using 5 mm Allen wrench. (See Figure 1)



NOTE: Top plate and base can be attached to either end of column.

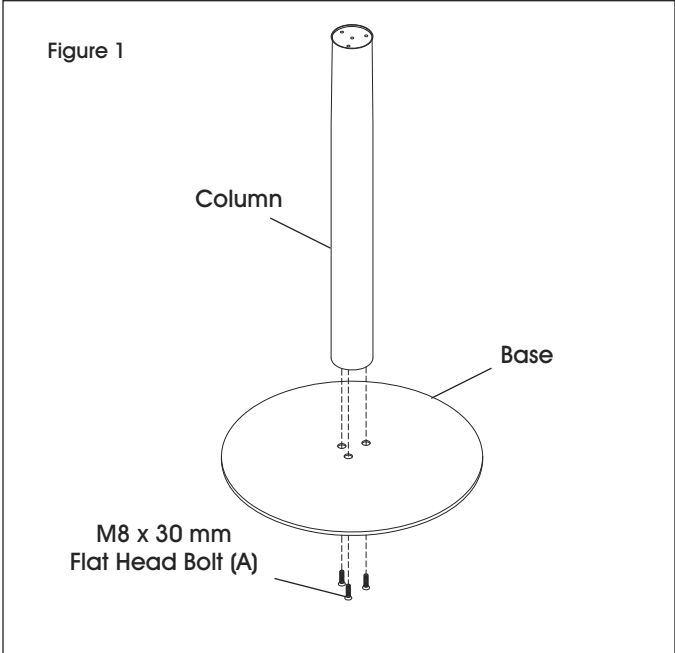

ASSEMBLY CONTINUED

2. Connect top plate to column using three M8 x 30 mm round head bolts (B). Tighten using 5 mm Allen wrench. (See Figure 2)

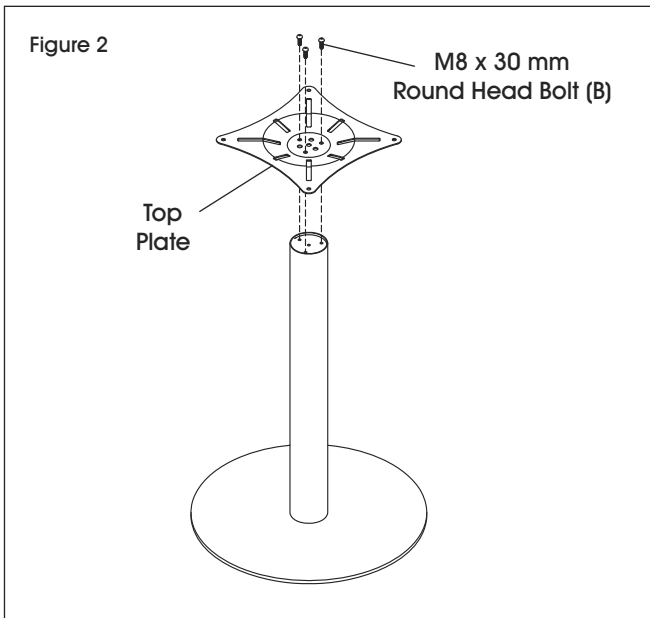

4. Bar height table is now fully assembled. Carefully flip the table onto base.

Completed Assembly

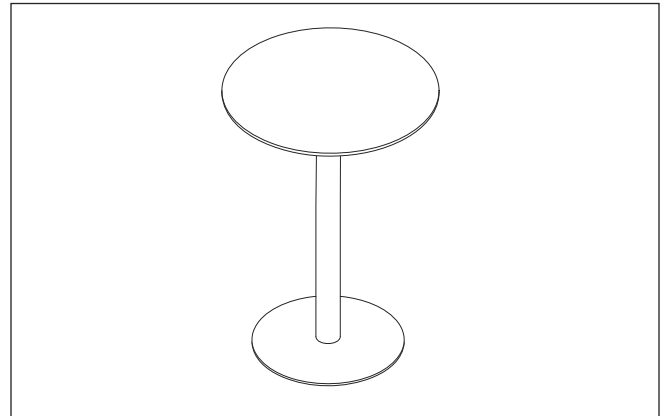

3. Align holes of top plate with holes on tabletop. Attach using four M6 x 15 mm bolts (C). Tighten using 4 mm Allen wrench. (See Figure 3)

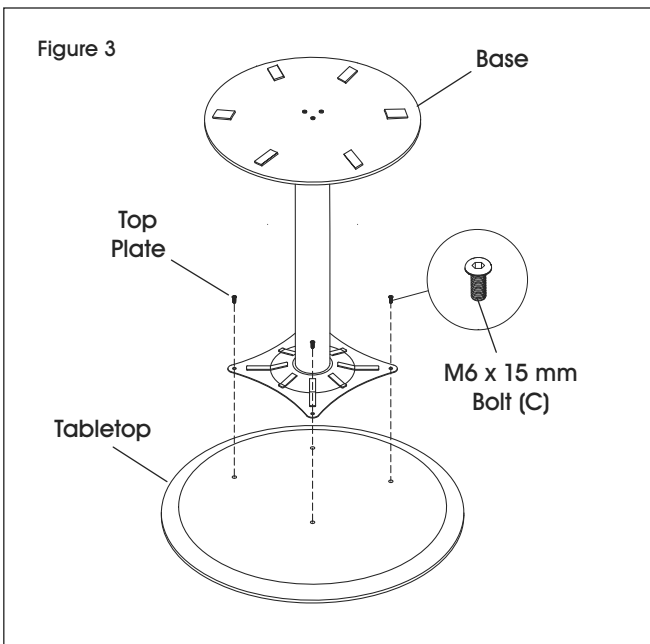

HERRAMIENTAS NECESARIAS



Llave Allen de 5 mm
Llave Allen de 4 mm
(incluidas)



Se recomienda Armar
Entre Dos Personas

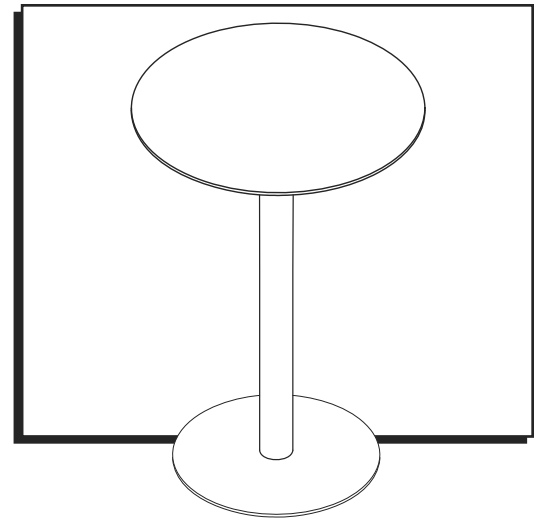

PARTES

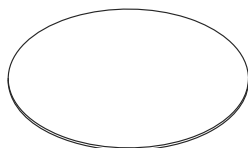

1 Cubierta de Mesa Redonda

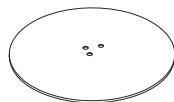

1 Base

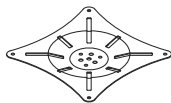

1 Placa Superior



1 Columna

Kit de Tornillería

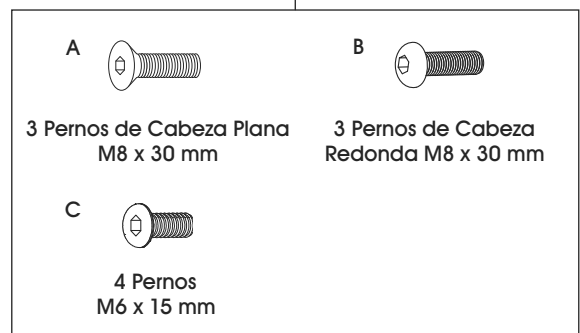

ENSAMBLE



NOTA: Ensamble la unidad sobre una superficie lisa que no deje marcas para evitar rayones.

- Verifique que todas las partes estén incluidas.

1. Conecte la base a la columna utilizando tres pernos de cabeza plana M8 x 30 mm (A). Apriete con la llave Allen de 5 mm. (Vea Diagrama 1)



NOTA: La placa superior y la base se pueden unir a cualquier extremo de la columna.

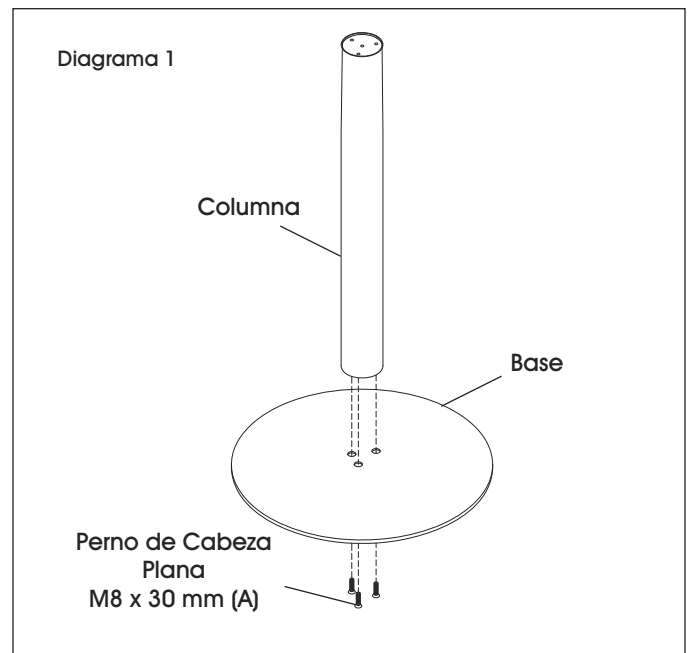

CONTINUACIÓN DEL ENSAMBLE

2. Conecte la placa superior a la columna utilizando tres pernos de cabeza redonda M8 x 30 mm (B). Apriete con la llave Allen de 5 mm. (Vea Diagrama 2)

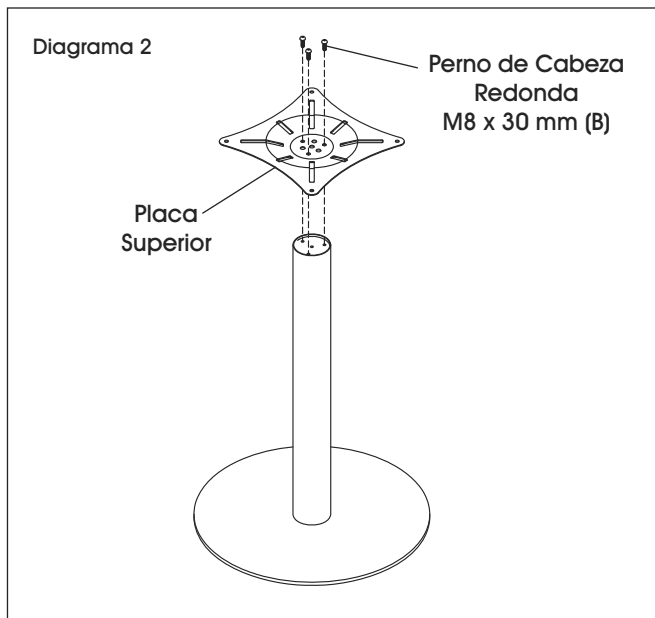

4. La mesa alta quedó ensamblada por completo. Voltee con cuidado la mesa sobre la base.

Ensamble Terminado

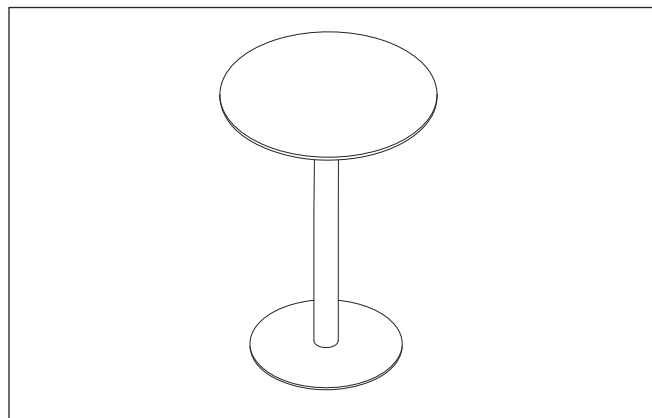

3. Alinee los orificios de la placa superior con los orificios en la cubierta. Fije utilizando cuatro pernos M6 x 15 mm (C). Apriete con la llave Allen de 4 mm. (Vea Diagrama 3)

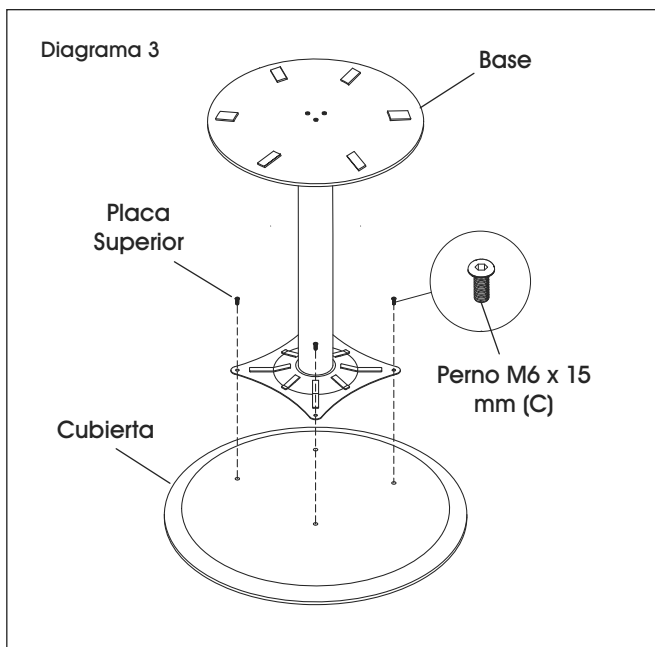

ULINE

800-295-5510
uline.mx

METRO – TABLE HAUTE DE BAR

OUTILS REQUIS



Clé Allen de 5 mm
Clé Allen de 4 mm
(inclus)



Montage à deux
personnes recommandé

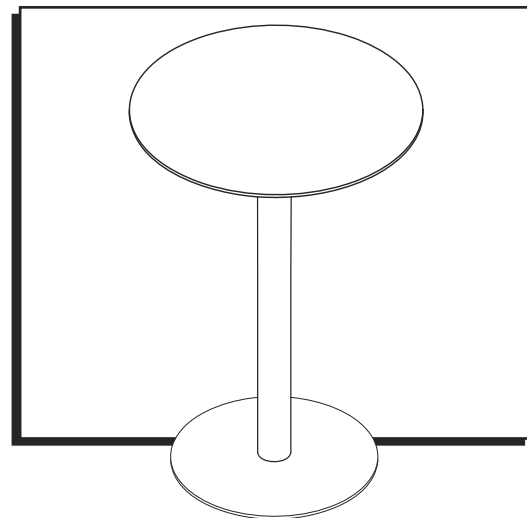

PIÈCES

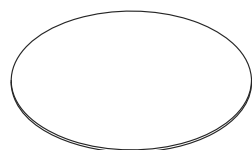

Surface de table ronde x 1

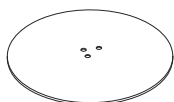

Base x 1

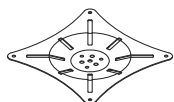

Plaque supérieure
x 1



Colonne x 1

Matériel de fixation

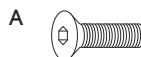

Boulon à tête plate
M8 x 30 mm x 3

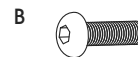

Boulon à tête ronde
M8 x 30 mm x 3



Boulon M6 x 15 mm
x 4

MONTAGE



REMARQUE : Montez le meuble sur une surface lisse qui ne marque pas afin d'éviter les rayures.

- Vérifiez que toutes les pièces sont incluses.

1. Connectez la base à la colonne à l'aide de trois boulons à tête plate M8 x 30 mm (A). Serrez le tout à l'aide de la clé Allen de 5 mm. (Voir Figure 1)



REMARQUE : La plaque supérieure et la base peuvent être attachées indifféremment de chaque côté de la colonne.

Figure 1

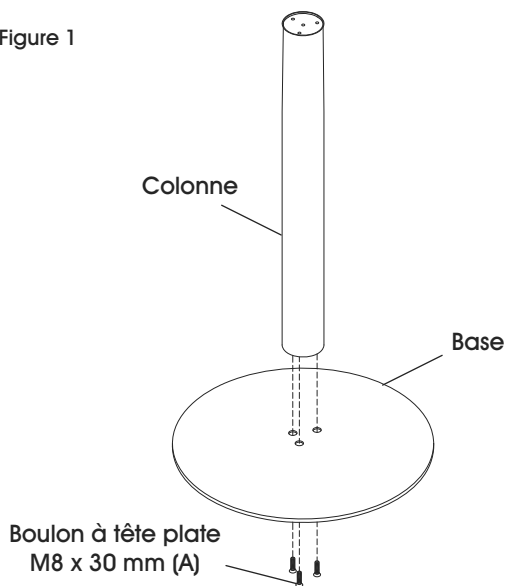

MONTAGE SUITE

- Fixez la plaque supérieure à la colonne à l'aide de trois boulons à tête ronde M8 x 30 mm (B). Serrez le tout à l'aide de la clé Allen de 5 mm. (Voir Figure 2)

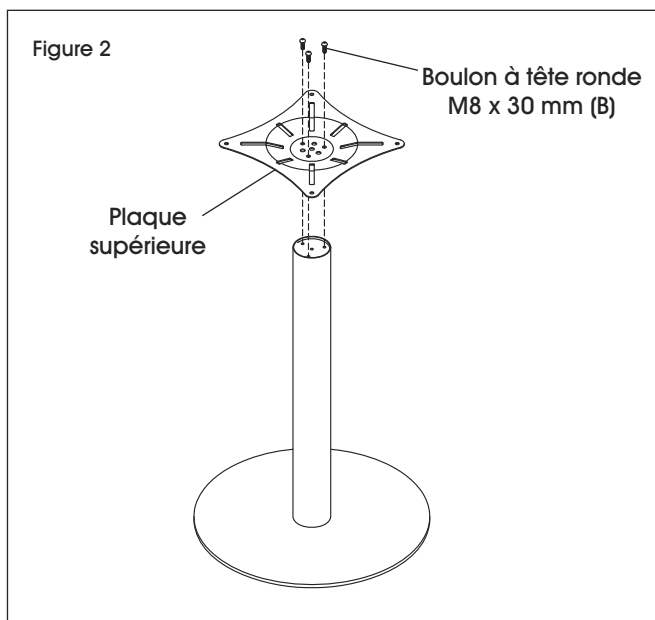

- Le montage de la table haute de bar est maintenant complété. Remettez avec soin la table à l'endroit.

Montage complété

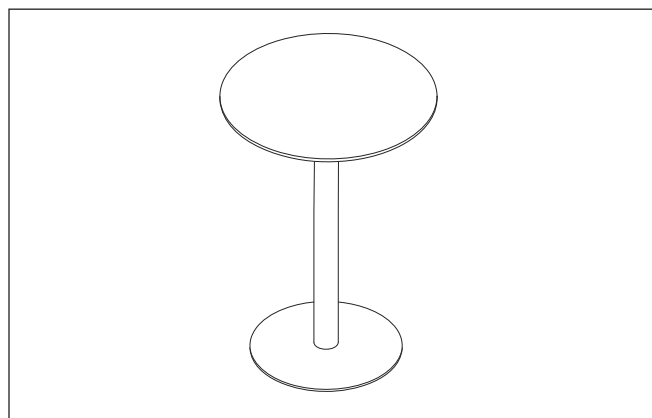

- Alignez les trous de la plaque supérieure sur ceux de la surface de table. Fixez-les avec quatre boulons M6 x 15 mm (C). Serrez le tout à l'aide de la clé Allen de 4 mm. (Voir Figure 3)

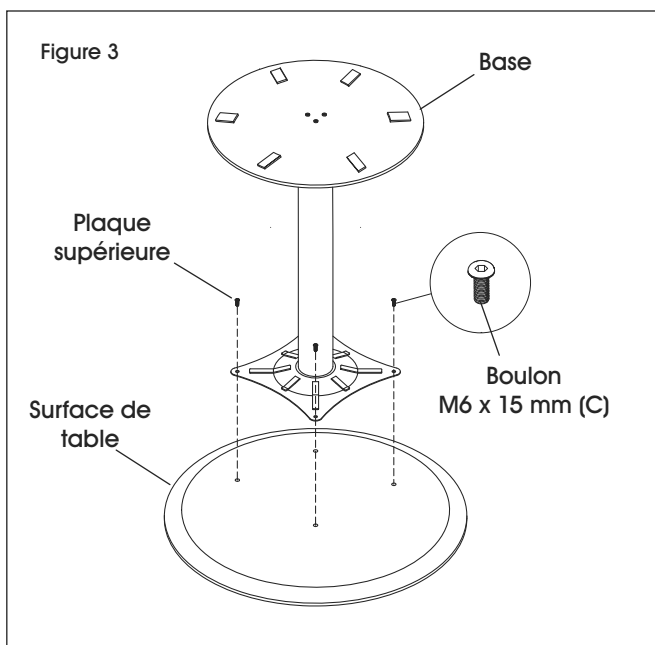

ULINE

1-800-295-5510
uline.ca