

ULINE H-11508 POWDER COATED URINAL PARTITION

1-800-295-5510
uline.com

TOOLS NEEDED

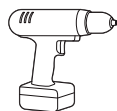

Electric Drill



3/16" Drill Bit
5/16" Drill Bit



T-27 Torx Bit

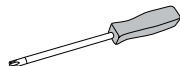

Torx Screwdriver



Two Person Assembly Recommended

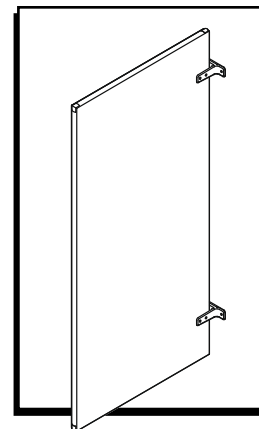

PARTS



Partition x 1

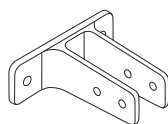

Bracket x 2



#10/12 x 1" Plastic Anchor x 4



#12 x 2.5" Screw x 4



#14 x 5/8" Screw x 8

INSTALLATION



NOTE: Before installing the urinal screen components, determine the correct location for application.

1. Draw a plumb line on the wall to mark the urinal screen center line. Measure from the floor and place marks on the urinal screen center line at 18" and 54".
2. Position and center brackets at each mark and urinal screen center line. Using the bracket as a template, mark the screw hole locations on the wall. Remove the bracket and drill a 5/16" hole (minimum 2.5" deep) at each hole location.
3. Insert plastic anchors in all holes and secure brackets to the wall with the #12 x 2.5" screws provided.
4. Ensure there is a 12" gap from the bottom of the urinal screen to the floor. Insert it into the wall brackets until a 1" gap between the wall and urinal screen is established.
5. Using the bracket as a template, drill 3/16" holes through the urinal screen at each bracket hole. Secure the urinal screen to the brackets with the #14 x 5/8" screws provided.

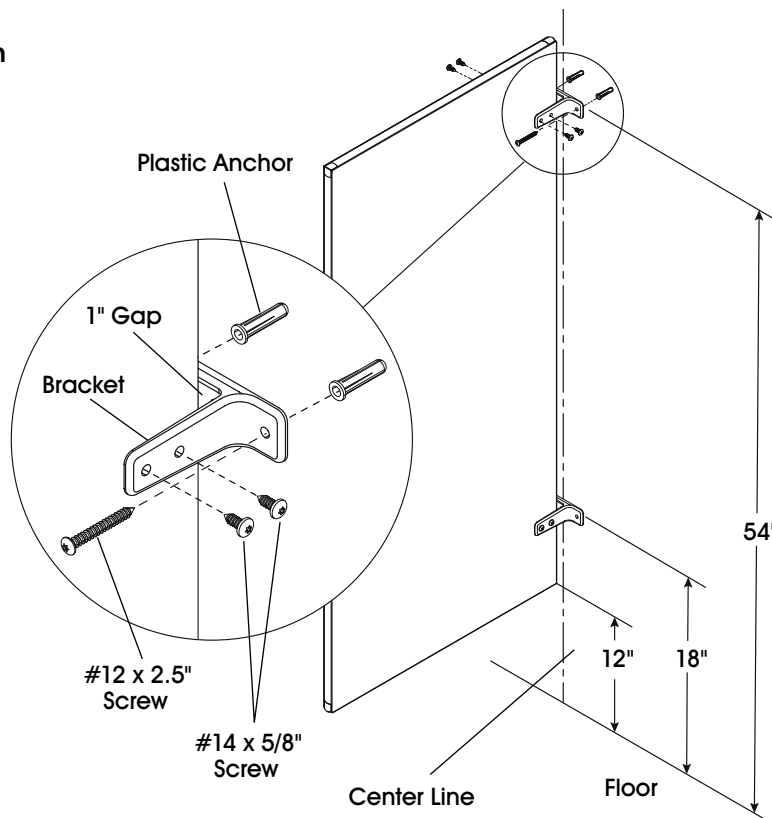

ULINE H-11508

800-295-5510

uline.mx

MAMPARA PARA MINGITORIOS – PULVIRREVESTIDO

HERRAMIENTAS NECESARIAS



Taladro Eléctrico



Broca de 3/16"
Broca de 5/16"



Punta Torx T-27

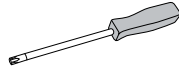

Desarmador Torx



Se recomienda Armar Entre Dos Personas

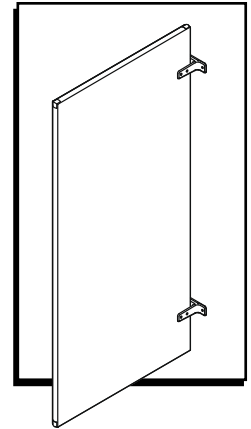

PARTES

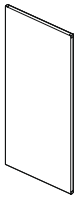

1 Mampara

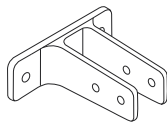

2 Soportes



4 Taquetes de Plástico #10/12 x 1"

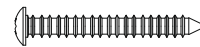

4 Tornillos #12 x 2"



8 Tornillos #14 x 5/8"

INSTALACIÓN



NOTA: Antes de instalar los componentes de la mampara para mingitorios, determine la ubicación correcta para la aplicación.

1. Trace una línea de plomada en la pared para marcar la línea central de la mampara para mingitorios. Mida desde el piso y coloque marcas en la línea central de la mampara para mingitorios a 46 cm (18") y 91 cm (54").
2. Coloque y centre los soportes en cada marca y la línea central de la mampara para mingitorios. Utilizando el soporte como plantilla, marque las ubicaciones de los orificios para tornillos en la pared. Retire el soporte y taladre un orificio de 5/16" [mínimo 5 cm (2") de profundidad] en cada marca para orificio.
3. Inserte los taquetes de plástico en todos los orificios y asegure los soportes a la pared con los tornillos proporcionados #12 x 2".
4. Asegúrese de que haya un espacio de 30 cm (12") entre la parte inferior de la mampara para mingitorios y el piso. Inserte la mampara en los soportes para pared hasta dejar un espacio de 2.5 cm (1") entre esta y la pared.
5. Utilizando el soporte como plantilla, taladre orificios de 3/16" a través de la mampara para mingitorios en cada orificio del soporte. Asegure la mampara a los soportes con los tornillos proporcionados #14 x 5/8".

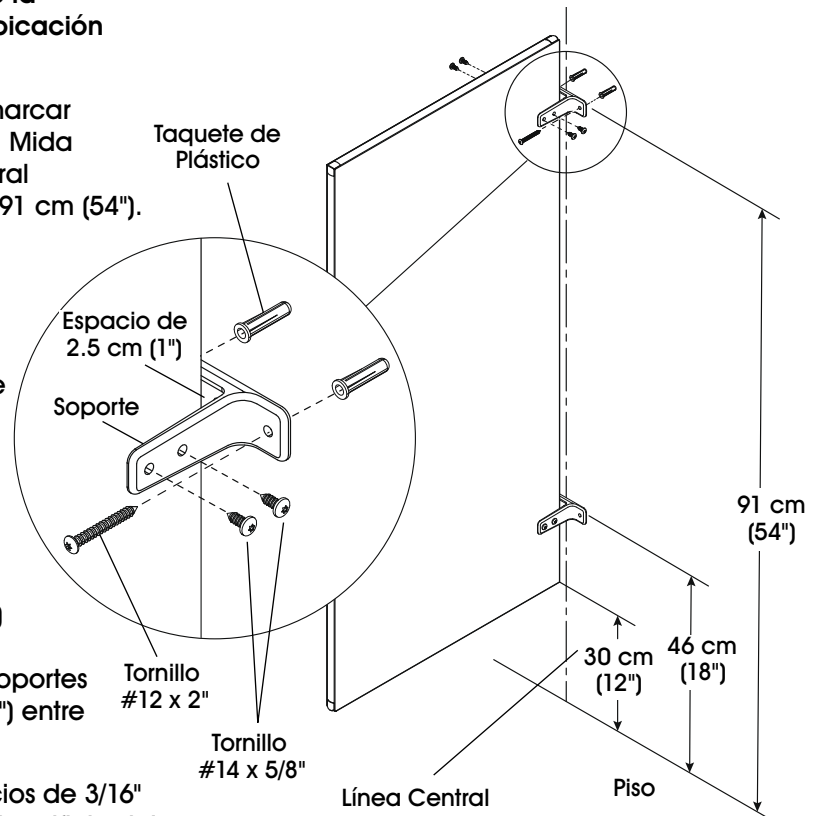

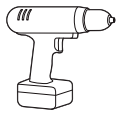
CLOISON POUR URINOIRS**OUTILS REQUIS**Montage à deux
personnes recommandéPerceuse
électriqueMèche de perceuse de 3/16 po
Mèche de perceuse de 5/16 po

Embout Torx T-27

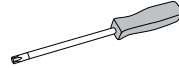

Tournevis Torx

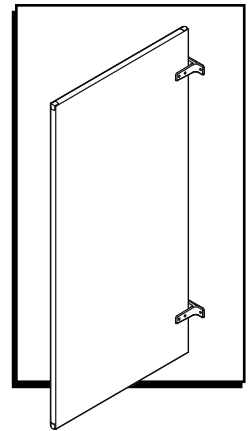
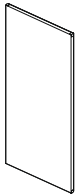
**PIÈCES**

Cloison x 1

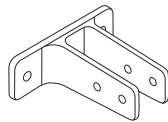

Support x 2

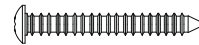
Vis n° 10/12 x 1 po
Ancrage en plastique x 4

Vis n° 12 x 2 po x 4



Vis n° 14 x 5/8 po x 8

INSTALLATION**REMARQUE : Déterminez l'emplacement approprié avant d'installer les composants de la cloison pour urinoir.**

- Tracez une ligne verticale sur le mur afin de marquer la ligne centrale de la cloison. Marquez un repère sur la ligne centrale de la cloison à 18 po et 54 po en mesurant à partir du plancher.
- Placez un support et centrez-le bien sur chacun des repères et sur la ligne centrale de la cloison. Utilisez le support comme modèle pour marquer l'emplacement des trous de vis sur le mur. Retirez le support et percez un trou de 5/16 po (2 po de profondeur minimum) à chaque emplacement.
- Insérez un ancrage en plastique dans les trous et fixez le support au mur avec les vis n° 12 x 2 po fournies.
- Assurez-vous d'avoir un espace de 12 po entre le bas de la cloison pour urinoir et le plancher. Insérez la cloison dans les supports muraux en laissant un espace de 1 po entre le mur et la cloison.
- Utilisez le support comme modèle et percez des trous de 3/16 po à travers la cloison à chaque trou du support. Fixez la cloison aux supports avec les vis n° 14 x 5/8 po fournies.

