

# OR-T 140 OR-T 270 OR-T 460

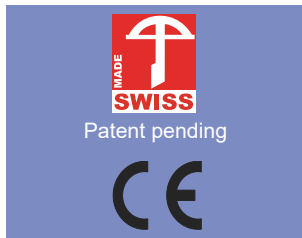

Battery-operated hand tool for plastic strapping

[www.orgapack-ort.com](http://www.orgapack-ort.com)

V 12.24\_EN



**Original operating instructions in accordance with the Machinery Directive 2006/42/EC.**

**Definition of original operating instructions**

The German version of this document is classed as the original operating instructions in accordance with the Machinery Directive 2006/42/EC.

**Translations**

All non-German language versions of this document are translations of the original operating instructions in accordance with the Machinery Directive 2006/42/EC.

Accordingly, only the original German operating instructions are legally binding.

**Read the operating instructions carefully before using the device.**

These operating instructions form part of the product, which is why they must be stored safely for later use or subsequent owners.

**Validity:**

- OR-T 140 from serial no. A/24085001
- OR-T 270 from serial no. B/24085001
- OR-T 460 from serial no. C/24085001

**Manufacturer**

Orgapack  
c/o Signode Switzerland GmbH  
Silberstrasse 14  
Postfach 595  
8953 Dietikon 1, SWITZERLAND  
[www.orgapack.com](http://www.orgapack.com)



**ULINE**

1-800-295-5510

[uline.com](http://uline.com)

## Table of contents

---

<b>1</b>	<b>General information</b>	<b>4</b>
<b>2</b>	<b>Safety</b>	<b>5</b>
2.1	Intended use	5
2.2	Working safely	5
2.3	General power tool safety warnings	5
2.4	Safety rules	8
<b>3</b>	<b>Description</b>	<b>10</b>
3.1	Structure	10
3.2	How the device works	11
3.3	Scope of delivery	11
3.4	Accessories	12
<b>4</b>	<b>Preparations for operation and settings</b>	<b>13</b>
4.1	Rechargeable battery	13
4.2	Setting the operating mode	14
4.3	Setting the tensioning force	15
4.4	Setting the unit for the tensioning force display	15
4.5	Setting the strap type	16
4.6	Setting the welding time	16
4.7	Switching the key lock on and off	16
4.8	Selecting the favourite function	17
4.9	Sleep mode	17
4.10	Setting the language	18
4.11	Service display	18
4.12	Reading the cycle status	18
<b>5</b>	<b>Operation</b>	<b>19</b>
5.1	Strapping	19
5.2	Checking the seal	21
5.3	Setting the strap widths	22
<b>6</b>	<b>Maintenance and repairs</b>	<b>25</b>
6.1	Maintenance table	25
6.2	Cleaning the device	25
6.3	Re-greasing the unit	25
6.4	Cleaning/replacing the tension wheel	26
6.5	Cleaning/replacing the tooth plate	27
6.6	Replacing the knife	28
6.7	Resetting the device	28
6.8	Eliminating faults	29
<b>7</b>	<b>Technical data</b>	<b>31</b>
<b>8</b>	<b>EC Declaration of Conformity (copy)</b>	<b>32</b>



# 1 General information

---

## Meaning of warning symbols, representation conventions



### **DANGER**

This text describes an extremely dangerous situation in which failure to observe the safety instructions will result in death or serious injury.

---



### **WARNING**

This text describes a dangerous situation in which failure to observe the safety instructions may result in death or serious injury.

---



### **CAUTION**

This text describes a dangerous situation in which failure to observe the safety instructions may result in minor injury.

---



### **ATTENTION**

This text describes a situation that may lead to property damage or adverse operating results.

---



This text describes useful supplementary information.

---

- ▶ This symbol indicates handling steps.
  - This symbol indicates outcomes from the handling steps.
- This symbol indicates lists.

## **Disposal and environmental protection**

No physical or chemical substances that are harmful to health were used to manufacture this device.

It is important to protect health and also promote the reuse and environmentally-appropriate recycling of waste. The following harmonised standards have also been taken into consideration:

- Directive 2011/65/EU of 8 June 2011 on the restriction of the use of certain hazardous substances in electrical and electronic equipment (RoHS II).
- Directive 2012/19/EU of 4 July 2012 on waste electrical and electronic equipment (WEEE II).

The applicable legal regulations must be considered for the disposal.

- ▶ The charger and batteries should be passed on to bodies responsible for environmentally friendly recycling.
- ▶ Observe any information, warnings and instructions issued by the battery manufacturer.



**ULINE**

1-800-295-5510  
uline.com

## 2 Safety

### 2.1 Intended use

These devices are intended for strapping items such as packages, loaded pallets, etc. The devices are intended for strapping with packaging plastic straps (polypropylene and polyester, see chapter 7). Only use these devices as described in the operating instructions.

#### 2.1.1 Possible misuse

- These devices may not be used to strap items with steel straps.
- The strapping on packed goods may not be used to lift, suspend or pull the goods.
- The devices may not be modified without authorisation.
- The devices may not be used to compress goods.
- The devices may not be used to secure loads on vehicles, aircraft or ships.

### 2.2 Working safely

The operating instructions must always be available at the devices' operating location. They must be read and applied by all persons working with the devices or working in the immediate vicinity.

The devices may only be operated, maintained and repaired by trained personnel. In addition to the operating instructions, any locally applicable rules concerning accident prevention and safe and proper work must be observed.



The operator or their supervisor is responsible for strapping safely and selecting the strap width (chapter 7) appropriate to the packaged goods (dimensions, weight, edges, stability, transport, storage). Only the strap dimensions permitted for the specific device type may be used (chapter 7). The devices must be configured in accordance with the strap used and the packaged goods (chapter 4). The operator is responsible for the correct device settings.

#### Wearing personal protective equipment

- ▶ During work, wear eye and hand protection (cut-proof safety gloves) and safety shoes.



#### CAUTION

**Feet may be hit by falling hand-held devices.**

Wear safety shoes while working.

### 2.3 General power tool safety warnings



#### WARNING!

**Read all safety warnings, instructions, illustrations and specifications provided with this power tool.** Failure to follow all instructions listed below may result in electric shock, fire and/or serious injury.

**Save all warnings and instructions for future reference.**

The term "power tool" in the warnings refers to your mains-operated (corded) power tool or battery-operated (cordless) power tool.

#### 2.3.1 Work area safety

- a) **Keep work area clean and well lit.** Cluttered or dark areas invite accidents.
- b) **Do not operate power tools in explosive atmospheres, such as in the presence of flammable liquids, gases or dust.** Power tools create sparks which may ignite the dust or fumes.
- c) **Keep children and bystanders away while operating a power tool.** Distractions can cause you to lose control.

**ULINE**

1-800-295-5510  
uline.com

### 2.3.2 Electrical safety

- a) **Power tool plugs must match the outlet. Never modify the plug in any way. Do not use any adapter plugs with earthed (grounded) power tools.** Unmodified plugs and matching outlets will reduce risk of electric shock.
- b) **Avoid body contact with earthed or grounded surfaces, such as pipes, radiators, ranges and refrigerators.** There is an increased risk of electric shock if your body is earthed or grounded.
- c) **Do not expose power tools to rain or wet conditions.** Water entering a power tool will increase the risk of electric shock.
- d) **Do not abuse the cord. Never use the cord for carrying, pulling or unplugging the power tool. Keep cord away from heat, oil, sharp edges or moving parts.** Damaged or entangled cords increase the risk of electric shock.
- e) **When operating a power tool outdoors, use an extension cord suitable for outdoor use.** Use of a cord suitable for outdoor use reduces the risk of electric shock.
- f) **If operating a power tool in a damp location is unavoidable, use a residual current device (RCD) protected supply.** Use of an RCD reduces the risk of electric shock.

### 2.3.3 Personal safety

- a) **Stay alert, watch what you are doing and use common sense when operating a power tool. Do not use a power tool while you are tired or under the influence of drugs, alcohol or medication.** A moment of inattention while operating power tools may result in serious personal injury.
- b) **Use personal protective equipment. Always wear eye protection.** Protective equipment such as a dust mask, non-skid safety shoes, hard hat or hearing protection used for appropriate conditions will reduce personal injuries.
- c) **Prevent unintentional starting. Ensure the switch is in the off-position before connecting to power source and/or battery pack, picking up or carrying the tool.** Carrying power tools with your finger on the switch or energising power tools that have the switch on invites accidents.
- d) **Remove any adjusting key or wrench before turning the power tool on.** A wrench or a key left attached to a rotating part of the power tool may result in personal injury.
- e) **Do not overreach. Keep proper footing and balance at all times.** This enables better control of the power tool in unexpected situations.
- f) **Dress properly. Do not wear loose clothing or jewellery. Keep your hair and clothing away from moving parts.** Loose clothes, jewellery or long hair can be caught in moving parts.
- g) **If devices are provided for the connection of dust extraction and collection facilities, ensure these are connected and properly used.** Use of dust collection can reduce dust-related hazards.
- h) **Do not let familiarity gained from frequent use of tools allow you to become complacent and ignore tool safety principles.** A careless action can cause severe injury within a fraction of a second.

### 2.3.4 Power tool use and care

- a) **Do not force the power tool. Use the correct power tool for your application.** The correct power tool will do the job better and safer at the rate for which it was designed.
- b) **Do not use the power tool if the switch does not turn it on and off.** Any power tool that cannot be controlled with the switch is dangerous and must be repaired.
- c) **Disconnect the plug from the power source and/or remove the battery pack, if detachable, from the power tool before making any adjustments, changing accessories, or storing power tools.** Such preventive safety measures reduce the risk of starting the power tool accidentally.
- d) **Store idle power tools out of the reach of children and do not allow persons unfamiliar with the power tool or these instructions to operate the power tool.** Power tools are dangerous in the hands of untrained users.
- e) **Maintain power tools and accessories. Check for misalignment or binding of moving parts, breakage of parts and any other condition that may affect the power tool's operation. If damaged, have the power tool repaired before use.** Many accidents are caused by poorly maintained power tools.
- f) **Keep cutting tools sharp and clean.** Properly maintained cutting tools with sharp cutting edges are less likely to bind and are easier to control.



- g) **Use the power tool, accessories and tool bits etc. in accordance with these instructions, taking into account the working conditions and the work to be performed.** Use of the power tool for operations different from those intended could result in a hazardous situation.
- h) **Keep handles and grasping surfaces dry, clean and free from oil and grease.** Slippery handles and grasping surfaces do not allow for safe handling and control of the tool in unexpected situations.

#### 2.3.5 Battery tool use and care

- a) **Recharge only with the charger specified by the manufacturer.** A charger that is suitable for one type of battery pack may create a risk of fire when used with another battery pack.
- b) **Use power tools only with specifically designated battery packs.** Use of any other battery packs may create a risk of injury and fire.
- c) **When battery pack is not in use, keep it away from other metal objects, like paper clips, coins, keys, nails, screws or other small metal objects, that can make a connection from one terminal to another.** Shorting the battery terminals together may cause burns or a fire.
- d) **Under abusive conditions, liquid may be ejected from the battery; avoid contact. If contact accidentally occurs, flush with water. If liquid contacts eyes, additionally seek medical help.** Liquid ejected from the battery may cause irritation or burns.
- e) **Do not use a battery pack or tool that is damaged or modified.** Damaged or modified batteries may exhibit unpredictable behaviour resulting in fire, explosion or risk of injury.
- f) **Do not expose a battery pack or tool to fire or excessive temperature.** Exposure to fire or temperature above 130 °C may cause explosion.
- g) **Follow all charging instructions and do not charge the battery pack or tool outside the temperature range specified in the instructions.** Charging improperly or at temperatures outside the specified range may damage the battery and increase the risk of fire.

#### 2.3.6 Service

- a) **Have your power tool serviced by a qualified repair person using only identical replacement parts.** This will ensure that the safety of the power tool is maintained.
- b) **Never service damaged battery packs.** Service of battery packs should only be performed by the manufacturer or authorized service providers.



1-800-295-5510  
uline.com

## 2.4 Safety rules



### WARNING

Read all safety information and instructions in these operating instructions and in the operating instructions for the charger.

Failure to observe the safety information and instructions may result in electric shocks, fires and/or severe injury. The following hazards may cause severe injuries:

#### Strap tearing or strap tangling, risk of clamping and crushing

When strapping, do not place your hands or other body parts between the strap and the packaged goods. Instruct other people to stay out of the danger area (1).

#### For an emergency stop in the event of hazards (trapped person):

- In the "Auto" operating mode, the strapping process is interrupted by pressing the tensioning or welding button; the motor switches off straight away but the tension is not released.
- To release the tension in the strap (before welding), operate the trigger.
- After welding, cut the strap with a tool (strap shears).

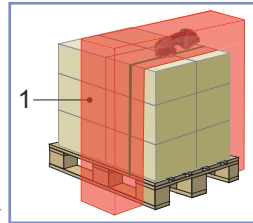

### WARNING

The following hazards may cause severe injuries:

#### Loose and falling packaged goods due to improper strapping

Check the sealing. Never transport packaged goods that have not been strapped correctly (chapter 5.2).

#### Never lift packaged goods up by the strapping, risk of injury

The strapping is designed to only be used for securing packaged goods during transport, storage, etc.



#### Risk of explosion in EX zones

The device may not be used in areas where an explosive atmosphere could form.



#### Moving parts in the tensioning mechanism, risk of crushing

Never reach into the operating range of moving parts. Clothes may become trapped and pulled into the mechanism.



#### Moving parts in the tensioning mechanism, risk of shearing

Never reach into the operating range of moving parts. Clothes may become trapped and pulled into the mechanism.

#### Lack of safety equipment, risk of crushing and cutting injuries

Devices may only be operated if their covers and housing components have been mounted.

#### Tearing straps, risk of injury

While under tension, the strap can tear and snap back. Do not stand in the strap's flight path. Wear protective eye wear.

#### Flying strap ends, risk of injury

When cutting the strap, hold the upper part tight and stand clear. Do not stand in the strap's flight path. Wear protective eye wear.

#### Compressed air for cleaning work, risk of injury

When blowing with compressed air, make sure that no air penetrates any skin lesions on your body. Use blow guns with multi-hole jets. Wear protective eye wear. Make sure air blow gun and nozzle complies with the applicable local standards.

#### Injury caused by hazardous substances

Products may contain hazardous substances that suddenly start to leak while being strapped. Wear personal protective equipment appropriate to the potential hazard.

**ULINE**

1-800-295-5510

uline.com



### **WARNING**

The following hazards may cause severe injuries:

---

#### **Injury due to projectile moving parts caused by breakage or incorrect assembly after maintenance**

Wear safety goggles while strapping

---

#### **Excessive strain on wrists and back**

Adopt a suitable working height and take breaks from your work.



### **CAUTION**

The following dangers can result in minor or moderate injury:

---

#### **Noise exposure**

Wearing hearing protection is recommended.

---

#### **Vibration exposure**

The vibration level specified in these instructions was measured in a measurement process standardised in accordance with EN 60745 and can be used to compare different electric tools. It is also suitable for a preliminary estimation of the vibration load.

The vibration emission value measured may deviate from the specified value depending on the actual application, the strap used and the manner of operation. Under certain circumstances, the vibration load may be increased over the entire work period. For a more accurate assessment of the vibration load, the times should also be considered when the device is switched off, or is running but not actually being used. This could reduce the vibration load significantly over the entire work period.

Define additional safety measures against the effect of vibrations for the protection of the operator, such as, for example: maintenance of the power tool, keeping hands warm and organisation of work processes.



### **ATTENTION**

Avoid damage to the device:

---

#### **Water damage**

Do not clean the device with water or steam. Protect the device against rain when using it outdoors.

---

#### **Always use genuine spare parts**

The use of other spare parts excludes warranty services and liability.

**ULINE**

1-800-295-5510

uline.com

# 3 Description

## 3.1 Structure

- 1 Button "1" = Tensioning button
- 2 Button "2" = Welding button
- 3 Handle
- 4 Trigger
- 5 Control panel
- 6 Battery release button
- 7 Battery
- 8 Type designation
- 9 Strap guide display
- 10 Serial number (XYMMYYYY)
- X → A=OR-T 140, B=OR-T 270, C=OR-T 460
- JJ → Year of manufacture
- MM → Month
- YYYY → Consecutive number
- 11 Welding unit
- 12 Tensioning mechanism

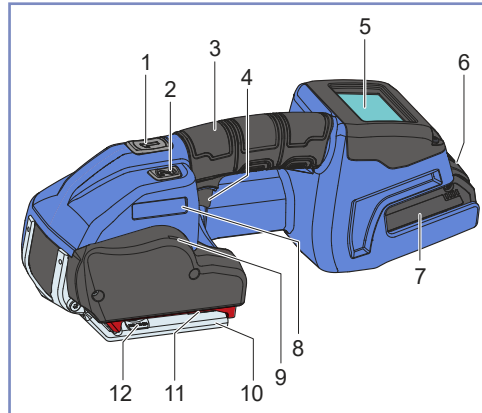

### "Home" screen on the control panel

- 1 "Tensioning force" field
- 2 "Strap type" field
- 3 "Favourite" field
- 4 "Settings" field
- 5 "Operating mode" field
- 6 "Welding time" field
- a "Home" display
- b "Operation/Service" status bar
- c "Info icons" display
- d "Battery charge level" display

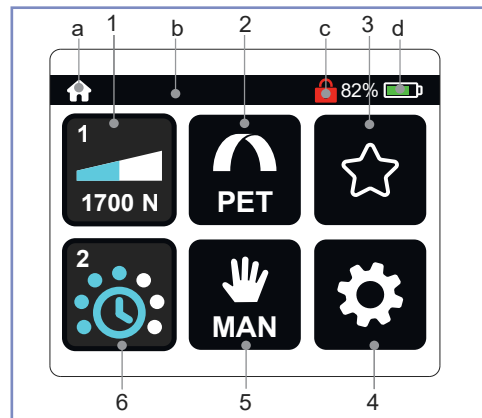

### Battery and charger

- 1 Charger
- 2 Battery
- 3 LED display

 For in-depth information, see the separately enclosed operating instructions for the battery and charger.



### 3.2 How the device works

- Operating the trigger opens the tensioning mechanism (1) for inserting the strapping.
- The strapping is inserted between the tooth plate (2) and the tension wheel (3).
- The strapping is tensioned when the tension wheel (3) is turned anti-clockwise.
- The welding unit (4) seals the strapping using the friction welding approach.
- The cutter (5) cuts off the upper strap.

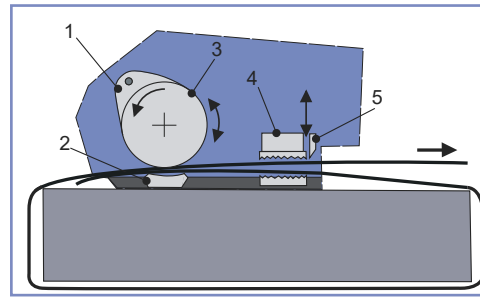

<ul style="list-style-type: none"> <li>• Three operating modes are available: (chapter 4.2)</li> </ul>	<ul style="list-style-type: none"> <li>- Semi-automatic (standard/default setting)</li> <li>- Fully automatic</li> <li>- Manual</li> </ul>
<ul style="list-style-type: none"> <li>• Two tensioning ranges are available: (chapter 4.3/4.4)</li> </ul>	<ul style="list-style-type: none"> <li>- Tensioning range for PET straps</li> <li>- Tensioning range for PP straps (reduced start-up speed for the tension wheel; prevents excessive device contamination)</li> </ul>
<ul style="list-style-type: none"> <li>• The welding time is adjustable (chapter 4.6).</li> </ul>	<ul style="list-style-type: none"> <li>- Seven steps</li> </ul>
<ul style="list-style-type: none"> <li>• The devices can be operated with various strapping widths (chapter 7):</li> </ul>	<ul style="list-style-type: none"> <li>- OR-T 140: 9–10 mm, 12–13 mm</li> <li>- OR-T 270: 12–13 mm, 15–16 mm</li> <li>- OR-T 460: 15–16 mm, 18–19 mm</li> </ul>

### 3.3 Scope of delivery

For OR-T 140/OR-T 270/OR-T 460:

EU version	• Li-Ion battery, 18 V 4.0 Ah EU Pro Core	Article no. 2187.040
USA version	• Li-Ion battery, 18 V 4.0 Ah US Core	Article no. 2187.041
Japan version	• Li-Ion battery, 18 V 4.0 Ah JP Pro Core	Article no. 2187.042

**ULINE**

1-800-295-5510  
uline.com

### 3.4 Accessories

- Guard plate set  
Article no. 2189.030

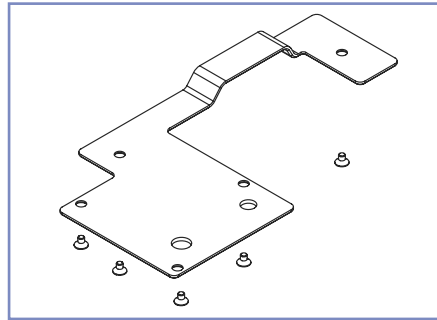

- Charger GAL 1840  
GAL1840 230 V EU - Article no. 2188.030  
GAL1840 115 V US - Article no. 2188.031  
GAL1840 100 V JP - Article no. 2188.032  
GAL1840 240 V AUS - Article no. 2188.033  
GAL1840 230 V UK - Article no. 2188.034

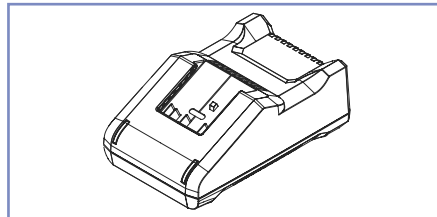

- Hanging bracket set  
Article no. 2189.031

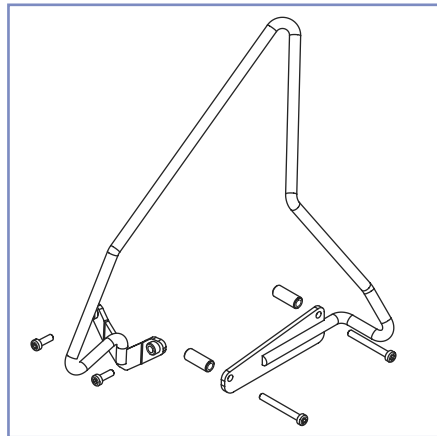

- Protection slide set  
Article no. 2189.032

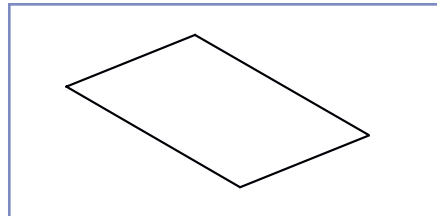

## 4 Preparations for operation and settings

### 4.1 Rechargeable battery

For in-depth information, see the separately enclosed operating instructions for the battery and charger.



#### WARNING

Only ever use Bosch rechargeable batteries and chargers as described in these operating instructions (chapter 3.3). Using any other rechargeable batteries/chargers can lead to injuries or fires. To reduce the risk of injuries or fire, read the charger operating instructions before using the charger and rechargeable battery.

#### 4.1.1 Charging the rechargeable battery

- ▶ Connect the charger to the mains.
  - The green LED lights up (charger ready for operation).
- ▶ Insert the battery into the charger.
  - Green LED flashes: Battery is charging.
  - Green LED lit up: Battery is fully charged.
  - Red LED lit up: Battery temperature is outside the permitted charging temperature range.
  - Red LED flashes: See the operating instructions for the charger.



- Charging time: Charging up a flat battery:  
48 min = approx. 80%, 65 min = approx. 100% charging capacity.
- Ideal battery temperature while charging: 15–40°C.
- Avoid battery temperatures below 0°C and above +45°C while charging.
- The battery can be charged at any time regardless of the charge level.

#### 4.1.2 Inserting and removing the rechargeable battery

- ▶ Inserting the rechargeable battery: Insert the charged battery into the device. The release button must engage at the second point (the first point keeps the battery in the device but does not establish electrical contact).
  - The displays on the control panel light up.
- If the device is not used for approx. two minutes, the display switches to sleep mode. Disabling sleep mode: Operate the trigger.
- If the device is not used for an extended period (several days), the rechargeable battery must be removed from the device and charged/stored in the charger.
- ▶ Removing the battery: Press the release button and pull out the battery at the same time.

#### 4.1.3 Checking the charge level

- ▶ “Battery charge level” LED display on the control panel when the battery is inserted:
  - The charge level is shown as a % and with a progress bar (1).
  - Below 10%: Minimum charge, battery must be charged.
  - The info icons (2) only appear if a corresponding status applies (chapter 6.8).

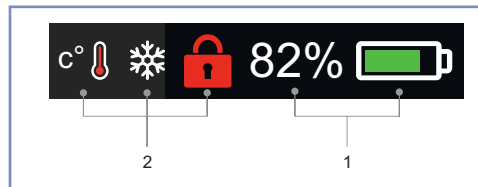

**ULINE**

1-800-295-5510  
uline.com

## 4.2 Setting the operating mode

- ▶ Press the “Operating mode” (1) button.
  - The **MAN/SEMI/AUTO** and “Confirm input” buttons are displayed.
  - The operating mode currently selected is displayed in blue.
- ▶ Press on the **MAN/SEMI/AUTO** operating mode to set it.
- ▶ Pressing the “Confirm input” (2) button saves the selected mode.
  - The display switches back to the “Home” page.



Use the following descriptions to help you select the right operating mode for your application: (The illustrations are symbolic. Their use may deviate from these.)

### • **MAN – Manual**

#### **Recommended for different (soft, hard packaged goods).**

The tensioning button (chapter 3.1, pos. 1) must be pressed until the desired strap tension is reached. The welding button (chapter 3.1, pos. 2) must then be pressed to weld the straps and cut off the top strap.

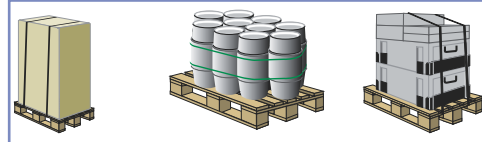

### • **SEMI – Semi-automatic**

#### **Recommended for packaged goods that are the same. (standard/default setting)**

The tensioning button (chapter 3.1, pos. 1) must be pressed until the set tensioning force is reached. The straps are then welded automatically and the upper strap is cut off. You can also press the welding button at any time to weld manually.

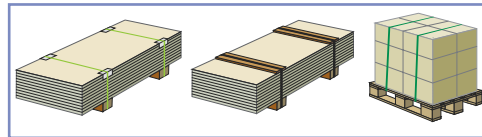

### • **AUTO – Fully automatic**

#### **Recommended for large quantities of identical packaged goods.**

The tensioning button (chapter 3.1., pos. 1) only has to be pressed briefly (tapped). This initiates the tensioning process. Once the set tensioning force has been reached, the straps are welded automatically and the upper strap is cut off.

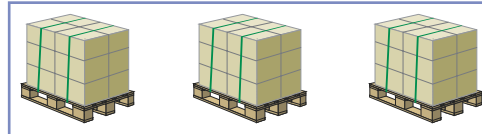

### **WARNING**

#### **Strap tearing or strap tangling, risk of clamping and crushing**

When strapping, do not place your hands or other body parts between the strap and the packaged goods. Instruct other people to stay out of the danger area (chapter 2.4).

#### **For an emergency stop in the event of hazards (trapped person):**

- Press the trigger (4), tensioning button (1) or welding button (2) to stop the motor immediately.
- Press the trigger (4) to release the tension in the strap.
- After welding, cut the strap with the tool (strap shears).

**ULINE**

1-800-295-5510  
uline.com

### 4.3 Setting the tensioning force

- ▶ Press the “Tensioning force” (1) button.
  - The set tensioning force is displayed with a blue status bar (2). Below this, the tensioning force is displayed as a numerical value with the unit (3).
- ▶ Manually move the status bar (2) to the left or right until the desired tensioning force is displayed.
  - The status bar (2) shows the set tensioning force in relation to the maximum possible value.
- ▶ Pressing the “Confirm input” (4) button saves the set tensioning force
  - The display switches back to the “Home” page.

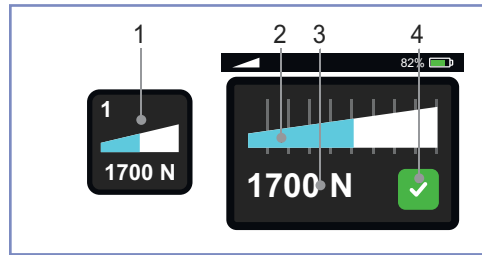

### 4.4 Setting the unit for the tensioning force display

- ▶ On the “Home” screen, press the “Settings” button (1).
- ▶ On the “Settings” screen, press the “Tensioning force unit” button (2).
  - The **N/lbf** and “Confirm input” buttons are displayed.
  - The unit currently selected is displayed in blue.
- ▶ Press the **N** or **lbf** unit to set it.
- ▶ Pressing the “Confirm input” (3) button saves the set unit for the tensioning force. – The display switches back to the “Settings” page.

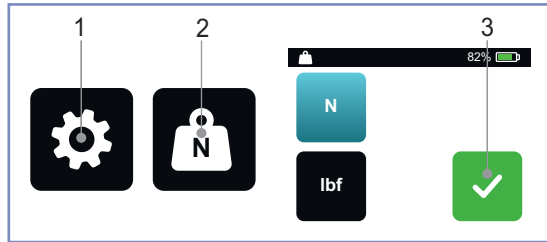

#### Overview of the adjustable tensioning force values

##### OR-T 140:

PET	N*	400	500	600	700	800	900	1000	1100	1200
	lbf*	90	110	135	155	180	200	225	250	270
PP	N	150	225	300	375	450	525	600	675	750
	lbf	33	50	67	85	100	120	135	150	165

##### OR-T 270:

PET	N*	900	1,100	1,300	1,500	1,700	1,900	2,100	2,300	2,500
	lbf*	200	250	290	340	380	430	470	520	560
PP	N	400	520	640	760	880	1,000	1,120	1,240	1,360
	lbf	90	115	145	170	200	225	250	280	305

##### OR-T 460:

PET	N*	1,300	1,700	2,100	2,500	2,900	3,300	3,700	4,100	4,500
	lbf*	290	380	470	560	650	740	830	920	1,000
PP	N	400	550	700	850	1,000	1,150	1,300	1,450	1,600
	lbf	90	120	160	190	225	260	290	325	360

(Values are rounded) \* N = Newton, lbf = pound-force per square inch

**ULINE**

1-800-295-5510  
uline.com

## 4.5 Setting the strap type

- ▶ Press the “Tensioning strap” (1) button.
  - The **PET/PP** and “Confirm input” buttons are displayed.
  - The strap type currently selected is displayed in blue.
- ▶ Select the strap type **PET** (polyester) or **PP** (polypropylene) to set it.
  - With the PP setting, the tension wheel starts up more slowly and the tensioning force is reduced. This prevents excessive contamination.
- ▶ Pressing the “Confirm input” (2) button saves the set strap type.
  - The display switches back to the “Home” page.

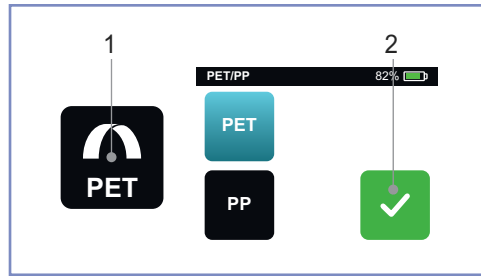

## 4.6 Setting the welding time

The set welding time is permanently displayed by way of filled-in dots when the device is ready for operation.

- ▶ Press the “Welding time” (1) button.
  - The set welding time is represented by filled-in dots around a clock symbol (2) and a numerical value (3).
- ▶ Directly selecting the dots sets the welding time.
- ▶ Pressing the “Confirm input” (4) button saves the set welding time.
  - The display switches back to the “Home” page.

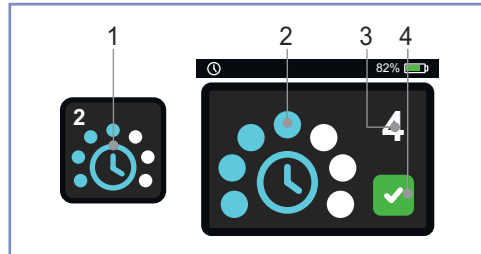

## 4.7 Switching the key lock on and off

The keypad can be locked to prevent the settings being changed accidentally.

- ▶ **Lock:** On the “Home” screen, press the “Settings” button (1).
- ▶ Press the “Key lock” (2) button
  - The input field for the locking code appears.
- ▶ Enter the four-digit locking code (5878). On request, this standard code can be changed by your service department.
- ▶ Pressing the “Confirm input” (3) button activates the key lock.
  - The display switches back to the “Home” page.
  - A red lock symbol appears next to the “Battery charge level” display in the status bar.
  - The lock symbol (2) appears as locked in the “Settings” menu.

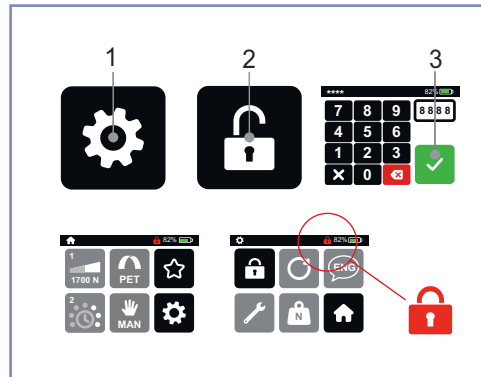

**ULINE**

1-800-295-5510  
uline.com

- ▶ **Unlock:** On the “Home” screen, press the “Settings” button (1).
- ▶ Press the “Key lock” (2) button
  - The input field for the locking code appears.
- ▶ Enter the four-digit locking code (5878).
- ▶ Pressing the “Confirm input” (3) button deactivates the key lock.
  - The display switches back to the “Home” page.
  - The lock symbol (2) appears as unlocked in the “Settings” menu.

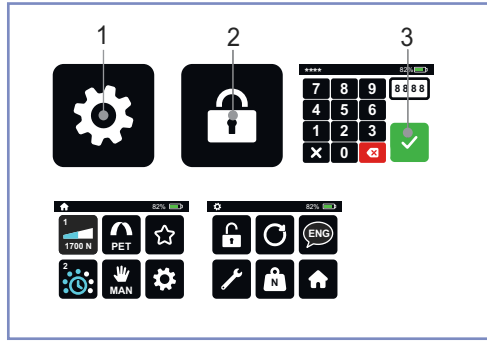

The favourite mode (chapter 4.8) can be switched on even when the key lock is activated. If you do not want the settings to be adjusted, the favourite level should be configured in the same way as the normal level.

## 4.8 Selecting the favourite function

The “Favourite” function activates a second level of settings, whose parameters can be freely configured in the same way as the main level. This enables the operator to quickly switch from one set of device settings to another.

### Activating the favourite function:

- ▶ Press the “Favourite” (1) button.
  - The star (2) switches from being empty to being filled in.
  - All parameters switch to the values pre-set in this settings level.

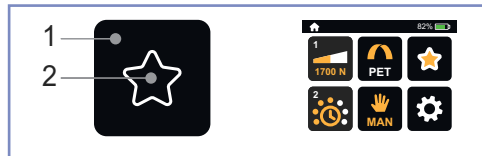

### Deactivating the favourite function:

- ▶ Press the “Favourite” (1) button.
  - The star (3) switches from being filled in to being empty.
  - All parameters switch to the values pre-set in this settings level.

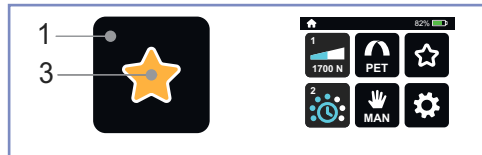

## 4.9 Sleep mode

To prevent the battery from draining when the device is not needed, the device switches to sleep mode if it has not been operated for approx. five minutes.

- The control panel is switched off (black).
- ▶ Pressing the trigger deactivates sleep mode.

**ULINE**

1-800-295-5510  
uline.com

#### 4.10 Setting the language

- ▶ On the “Home” screen, press the “Settings” button (1).

- ▶ Press the “Language selection” (2) button.
  - Several language buttons and the “Confirm input” button are displayed.
  - The language currently selected is displayed in blue.

- ▶ Directly pressing on your preferred language sets this as the new language.

- ▶ Pressing the “Confirm input” (3) button saves the selected language.

- The display changes back to the “Settings” menu and the appearance of the “Language” button changes to the selected language.

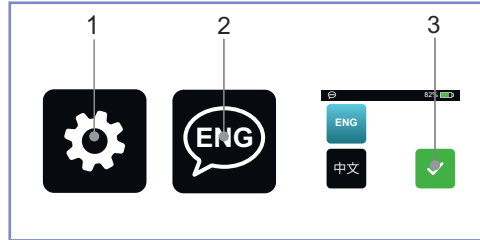

#### 4.11 Service display

- ▶ On the “Home” screen, press the “Settings” button (1).

- ▶ Press the “Service” (2) button.
  - The display switches to the service information screen (3,5,6).

- ▶ Pressing the “Confirm input” (4) button changes the display back to the “Settings” screen.

- ▶ Pressing the “Home” (7) button changes the display back to the “Home” screen.

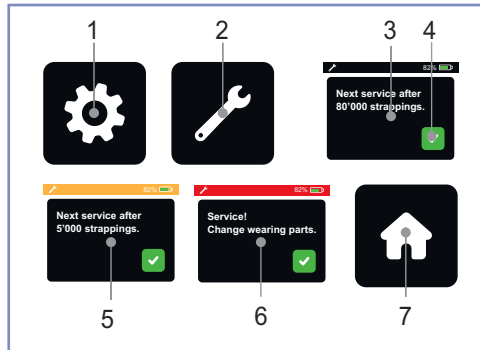

#### 4.12 Reading the cycle status

- ▶ On the “Home” screen, press the “Settings” button (1).

- ▶ Press the “Cycle counter” (2) button.
  - The input field for the cycle counter code appears.

- ▶ Enter the four-digit locking code (5878). On request, this standard code can be changed by your service department.

- ▶ Pressing the “Confirm input” (3) button displays the cycle counter screen.

- The number of device cycles is displayed.

- ▶ Pressing the “Confirm input” (4) button changes the display back to the “Settings” screen.

- ▶ Pressing the “Home” (5) button changes the display back to the “Home” screen.

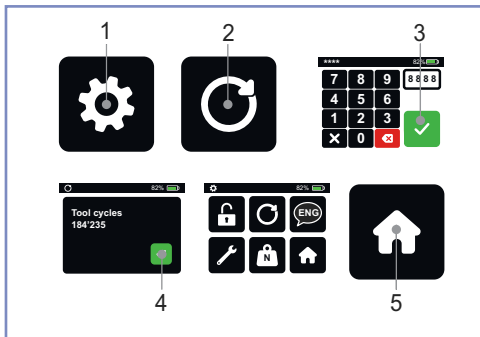

**ULINE**

1-800-295-5510  
uline.com

# 5 Operation

## 5.1 Strapping

### Requirements

- The device is set up for the width of the strap to be used (chapter 5.3).
- A charged battery is inserted (chapter 4.1.2).
- The required operating mode has been set up (chapter 4.2.). In this description, we are using the "SEMI" operating mode (semi-automatic) as an example.
- The required tensioning force has been set up (chapter 4.3).
- The required welding time has been set up (chapter 4.6).

- ▶ Guide the strap around the packaged good.
- ▶ With your left hand, grip the straps at the top of the packaged good so that:
  - The straps are on top of one another.
  - The start of the strap is at the bottom. Approx. 15 cm should protrude beyond your hand.

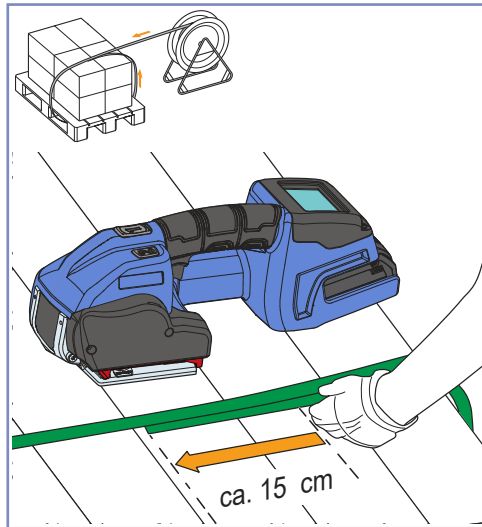

- ▶ Hold the device with your right hand.
- ▶ Operate the trigger (1).
  - The tensioning mechanism opens.
- ▶ Insert the layers of straps as far as they will go. The strap coming from the dispenser should be on the top.
- ▶ Release the trigger.
  - The straps are clamped in the tensioning mechanism.
  - The front end of the strap should protrude by approx. 5 cm.

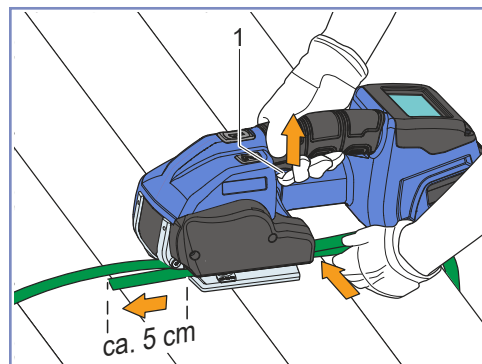

 If the strap is not inserted correctly, the tensioning mechanism (chapter 3.1/pos. 12) will not lower all the way down. As a result, the strap cannot be tightened. Insert the strap all the way in. The tensioning mechanism lowers and the strap is guided.

- ▶ **Remove hands from the straps before tensioning!**

**ULINE**

1-800-295-5510  
uline.com

**WARNING****Strap tearing or strap tangling, risk of clamping and crushing**

When strapping, do not place your hands or other body parts between the strap and the packaged goods. Instruct other people to stay out of the danger area (chapter 2.4).

**For an emergency stop in the event of hazards (trapped person):**

- Press the trigger (4), tensioning button (1) or welding button (2) to stop the motor immediately.
- Press the trigger (4) to release the tension in the strap.
- After welding, cut the strap with a tool (strap shears).

**CAUTION**

While under tension, the strap can tear and snap back. Do not stand in the strap's flight path. Wear protective goggles.

- ▶ Press and hold the tensioning button (1) until the set tensioning force has been reached.



The tensioning speed is variable depending on the pressure exerted on the tensioning button (MAN/SEMI operating mode). Pausing/continuing the tensioning process: Release the tensioning button/press it again.

- The display shows (A):  
The status bar (2) with the achieved tensioning force in relation to the set tensioning force (1).
- The tensioning process is completed when the status bar (2) is completely filled.

- ▶ The tensioning button can now be released.
  - The straps are now welded automatically and the upper strap is cut off.
  - The control panel displays:  
The welding process (B) and the cooling process (C).
  - At the end of the cooling time, an acoustic signal sounds and the control panel lights up green (D) for one second.



Welding without strap tension: Briefly press the tensioning button then press the welding button (chapter 3.1, pos. 2).

**CAUTION**

Hot welding point on the strap. Wear protective gloves

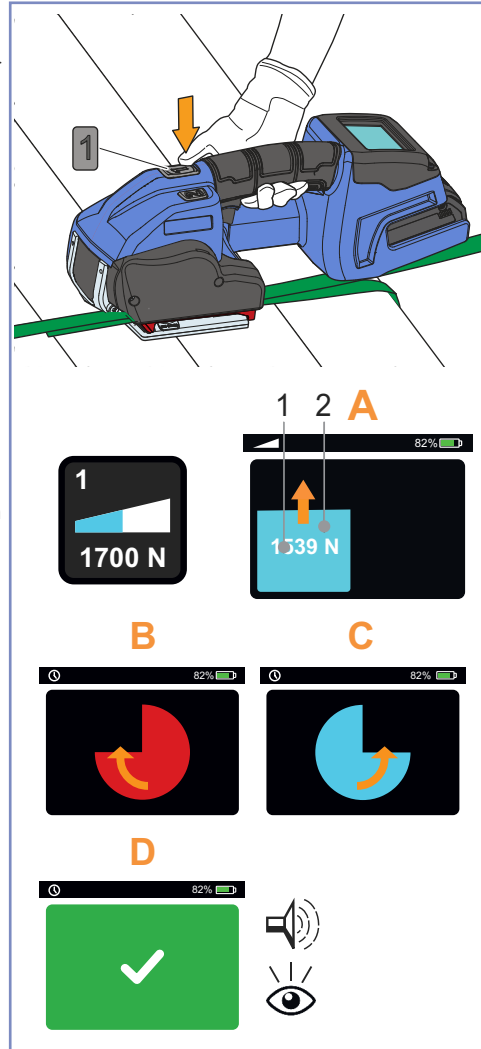
**ULINE**

1-800-295-5510

uline.com

- ▶ Once the display shows green and an acoustic signal sounds, the cooling time ends. Operate the trigger.
  - The tensioning mechanism opens.



Do not re-tension the strap after you have pressed the trigger (do not press the tensioning button again).

- ▶ Swivel the device backwards and to the right, away from the strapping.



#### WARNING

If the device is removed too early, an orange warning (1) appears on the control panel with a pulsing acoustic signal (chapter 6.8). This means that there is an application error. The strapping process failed.

- ▶ Perform a visual check of the seal (chapter 5.2).
- ▶ A red warning (2) appears on the control panel in the event of a device error.
- ▶ Perform a technical check of the device.

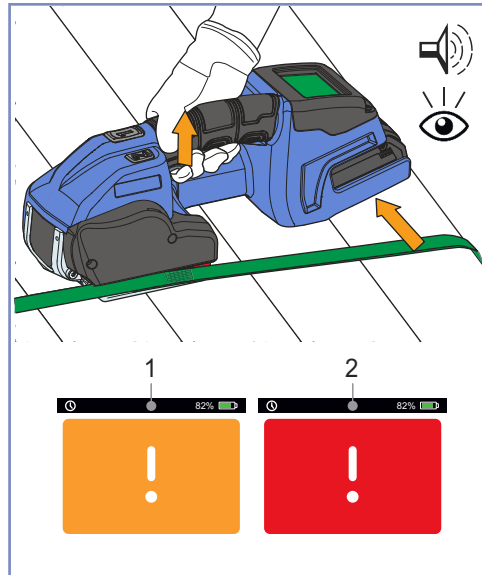

## 5.2 Checking the seal



#### WARNING

**Never transport or move packaged goods that have not been strapped or welded correctly. This could result in severe injuries.** Check the seal after each strapping process.

- ▶ Check the seal with a visual check.
  - 1 **Good sealing** (the entire sealing surface has been correctly welded without excess material being pressed out to the side).
  - 2 **Poor sealing** (the sealing does not extend over the entire sealing surface), the set welding time was too short.
  - 3 **Poor sealing** (excess material is pressed out to the side), the set welding time was too long.

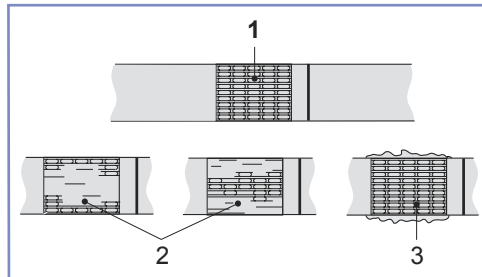

If the strap is poorly welded:

- ▶ Check the welding time setting (chapter 4.6).
- ▶ Strap the packaged goods again.
- ▶ Check the quality of the strap (chapter 7).
- ▶ If you are unable to achieve a good sealing, the device must be checked by the service department.

**ULINE**

1-800-295-5510  
uline.com

### 5.3 Setting the strap widths

The devices can be operated with the following strap widths:

- OR-T 140: 9–10 mm, 12–13 mm
- OR-T 270: 12–13 mm, 15–16 mm
- OR-T 460: 15–16 mm, 18–19 mm

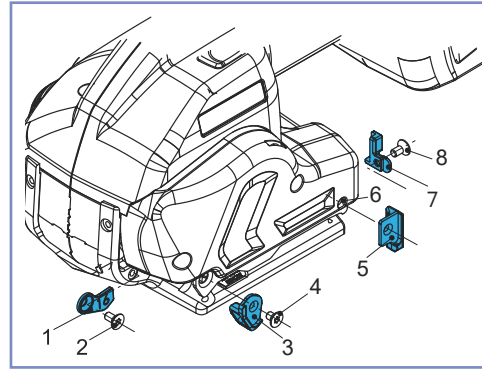

#### 5.3.1 OR-T 140: Converting from 10 mm to 13 mm

Required parts	Order number
Strap guide, internal, front 13 mm (1)	1832.031.150
Strap guide, external, front 13 mm (3)	1832.031.154
Strap guide, internal, rear 13 mm (7)	1832.041.037
Strap guide, external, rear 13 mm (5)	1832.031.156
Torx counter-sunk screw, M4x6 (4) (6)	1912.204.064
Torx counter-sunk screw, M4x10 (2) (8)	1912.204.104

- ▶ Remove the rechargeable battery from the device.
- ▶ Undo the Torx counter-sunk screw (2) and remove the strap guide, internal, front, 10 mm (1). Mount the strap guide, internal, front, 13 mm (1) (lock the Torx counter-sunk screw with Loctite®222).
- ▶ Undo the Torx counter-sunk screw (4) and remove the strap guide, external, front, 10 mm (3). Mount the strap guide, external, front, 13 mm (3) (lock the Torx counter-sunk screw with Loctite® 222).
- ▶ Undo the Torx counter-sunk screw (8) and remove the strap guide, internal, rear, 10 mm (7). Mount the strap guide, internal, rear, 13 mm (7) (lock the Torx counter-sunk screw with Loctite® 222)
- ▶ Undo the Torx counter-sunk screw (6) and remove the strap guide, external, rear, 10 mm (5). Mount the strap guide, external, rear, 13 mm (5) (lock the Torx counter-sunk screw with Loctite® 222).

#### OR-T 140: Converting from 13 mm to 10 mm

Required parts	Order number
Strap guide, internal, front 10 mm (1)	1832.031.164
Strap guide, external, front 10 mm (3)	1832.031.162
Strap guide, internal, rear 10 mm (7)	1832.041.040
Strap guide, external, rear 10 mm (5)	1832.031.163
Torx counter-sunk screw, M4x6 (4) (6)	1912.204.064
Torx counter-sunk screw, M4x10 (2) (8)	1912.204.104

- ▶ Remove the rechargeable battery from the device.
- ▶ Undo the Torx counter-sunk screw (2) and remove the strap guide, internal, front, 13 mm (1). Mount the strap guide, internal, front, 10 mm (1) (lock the Torx counter-sunk screw with Loctite® 222).
- ▶ Undo the Torx counter-sunk screw (4) and remove the strap guide, external, front, 13 mm (3). Mount the strap guide, external, front, 10 mm (3) (lock the Torx counter-sunk screw with Loctite® 222).



1-800-295-5510  
uline.com

- ▶ Undo the Torx counter-sunk screw (8) and remove the strap guide, internal, rear, 13 mm (7). Mount the strap guide, internal, rear, 10 mm (7) (lock the Torx counter-sunk screw with Loctite® 222).
- ▶ Undo the Torx counter-sunk screw (6) and remove the strap guide, external, rear, 13 mm (5). Mount the strap guide, external, rear, 10 mm (5) (lock the Torx counter-sunk screw with Loctite® 222).

### 5.3.2 OR-T 270: Converting from 13 mm to 16 mm

Required parts	Order number
Strap guide, internal, front 16 mm (1)	1832.031.152
Strap guide, external, front 16 mm (3)	1832.031.158
Strap guide, internal, rear 16 mm (7)	1832.041.035
Strap guide, external, rear 16 mm (5)	1832.031.157
Torx counter-sunk screw, M4x6 (4) (6)	1912.204.064
Torx counter-sunk screw, M4x10 (2) (8)	1912.204.104

- ▶ Remove the rechargeable battery from the device.
- ▶ Undo the counter-sunk screw (2) and remove the strap guide, internal, front, 13 mm (1). Mount the strap guide, internal, front, 16 mm (1) (lock the Torx counter-sunk screw with Loctite® 222).
- ▶ Undo the counter-sunk screw (4) and remove the strap guide, external, front, 13 mm (3). Mount the strap guide, external, front, 16 mm (3) (lock the Torx counter-sunk screw with Loctite® 222).
- ▶ Undo the counter-sunk screw (8) and remove the strap guide, internal, rear, 13 mm (7). Mount the strap guide, internal, rear, 16 mm (7) (lock the Torx counter-sunk screw with Loctite® 222).
- ▶ Undo the Torx counter-sunk screw (6) and remove the strap guide, external, rear, 13 mm (5). Mount the strap guide, external, rear, 16 mm (5) (lock the Torx counter-sunk screw with Loctite® 222).

### OR-T 270: Converting from 16 mm to 13 mm

Required parts	Order number
Strap guide, internal, front 13 mm (1)	1832.031.150
Strap guide, external, front 13 mm (3)	1832.031.154
Strap guide, internal, rear 13 mm (7)	1832.041.037
Strap guide, external, rear 13 mm (5)	1832.031.156
Torx counter-sunk screw, M4x6 (4) (6)	1912.204.064
Torx counter-sunk screw, M4x10 (2) (8)	1912.204.104

- ▶ Remove the rechargeable battery from the device.
- ▶ Undo the counter-sunk screw (2) and remove the strap guide, internal, front, 16 mm (1). Mount the strap guide, internal, front, 13 mm (1) (lock the Torx counter-sunk screw with Loctite® 222).
- ▶ Undo the counter-sunk screw (4) and remove the strap guide, external, front, 16 mm (3). Mount the strap guide, external, front, 13 mm (3) (lock the Torx counter-sunk screw with Loctite® 222).
- ▶ Undo the counter-sunk screw (8) and remove the strap guide, internal, rear, 16 mm (7). Mount the strap guide, internal, rear, 13 mm (7) (lock the Torx counter-sunk screw with Loctite® 222).
- ▶ Undo the Torx counter-sunk screw (6) and remove the strap guide, external, rear, 16 mm (5). Mount the strap guide, external, rear, 13 mm (5) (lock the Torx counter-sunk screw with Loctite® 222).



### 5.3.3 OR-T 460: Converting from 16 mm to 19 mm

Required parts	Order number
Strap guide, external, front 19 mm (3)	1832.031.159
Strap guide, internal, rear 19 mm (7)	1832.041.036
Strap guide, external, rear 19 mm (5)	1832.031.161
Torx counter-sunk screw, M4x6 (4) (6)	1912.204.064
Torx counter-sunk screw, M4x10 (2) (8)	1912.204.104

- ▶ Remove the rechargeable battery from the device.
- ▶ Undo the Torx counter-sunk screw (4) and remove the strap guide, external, front, 16 mm (3). Mount the strap guide, external, front, 19 mm (3) (lock the Torx counter-sunk screw with Loctite® 222).
- ▶ Undo the Torx counter-sunk screw (8) and remove the strap guide, internal, rear, 16 mm (7). Mount the strap guide, internal, rear, 19 mm (7) (lock the Torx counter-sunk screw with Loctite® 222).
- ▶ Undo the Torx counter-sunk screw (6) and remove the strap guide, external, rear, 16 mm (5). Mount the strap guide, external, rear, 19 mm (5) (lock the Torx counter-sunk screw with Loctite® 222).

### OR-T 460: Converting from 19 mm to 16 mm

Required parts	Order number
Strap guide, internal, front 16 mm (1)	1832.031.152
Strap guide, external, front 16 mm (3)	1832.031.158
Strap guide, internal, rear 16 mm (7)	1832.041.038
Strap guide, external, rear 16 mm (5)	1832.031.160
Torx counter-sunk screw, M4x6 (4) (6)	1912.204.064
Torx counter-sunk screw, M4x10 (2) (8)	1912.204.104

- ▶ Remove the rechargeable battery from the device.
- ▶ Mount the strap guide, internal, front, 16 mm (1) (lock the Torx counter-sunk screw with Loctite® 222).
- ▶ Undo the counter-sunk screw (4) and remove the strap guide, external, front, 19 mm (3). Mount the strap guide, external, front, 16 mm (3) (lock the Torx counter-sunk screw with Loctite® 222).
- ▶ Undo the counter-sunk screw (8) and remove the strap guide, internal, rear, 19 mm (7). Mount the strap guide, internal, rear, 16 mm (7) (lock the Torx counter-sunk screw with Loctite® 222).
- ▶ Undo the Torx counter-sunk screw (6) and remove the strap guide, external, rear, 19 mm (5). Mount the strap guide, external, rear, 16 mm (5) (lock the Torx counter-sunk screw with Loctite® 222).



## 6 Maintenance and repairs



### WARNING

**Unexpected startup during maintenance work, injuries possible.**

Always remove the rechargeable battery before performing cleaning, maintenance and repair work.

### 6.1 Maintenance table

Work	Interval (cycles)
Check device	– Daily
Clean the device (chapter 6.2)	– Daily (for > 300 strappings/day) – Weekly (for 100–300 strappings/day)
Re-grease the unit (chapter 6.3)	– Monthly (for 100–300 strappings/day)
Overhaul the device (recommended)	– Every 2 years or 80,000 strappings, service by specialist department

### 6.2 Cleaning the device

In the case of heavy dirt accumulation, we recommend cleaning the device regularly (daily). In particular, the tension wheel and the tooth plate should be checked for damage and kept clean.



### WARNING

Make sure you are wearing safety goggles before cleaning with compressed air! Use a compressed air gun with multi-hole jets for cleaning with compressed air. Make sure that the compressed air is not directed at any body parts (skin). Make sure air blow gun and nozzle complies with the applicable local standards.

- ▶ In the right housing shell beneath the motor, there are two blow holes (Ø 3 mm), through which the compressed air is blown first to clean the welding unit.
- ▶ After this, clean the tension wheel and tooth plate with compressed air by blowing them out from the sides.
- ▶ If necessary, clean/replace the tension wheel/tooth plate (chapter 6.4/6.5).

### 6.3 Re-greasing the unit

To ensure optimal stability, we recommend re-greasing the device regularly.

- ▶ Remove the rechargeable battery from the device. Remove the strap guide, internal, rear (2). Undo the two Torx cylinder head screws (1) and remove the side cover (3).
- ▶ Carefully spray the welding unit at the two points (4) with a high-pressure-resistant adhesive lubricating oil spray (e.g. Würth HHS 2000).
- ▶ Re-mount the side cover (3) and strap guide, internal, rear (2).

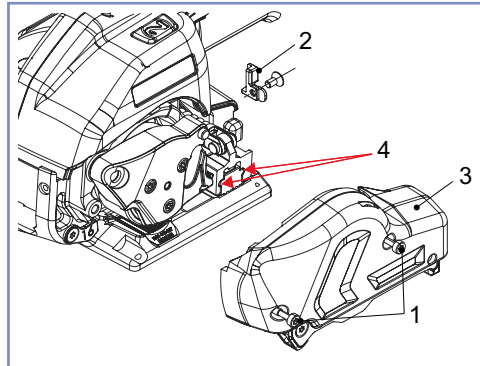

**ULINE**

1-800-295-5510

uline.com

## 6.4 Cleaning/replacing the tension wheel

Required parts	Order number
<b>OR-T 140/OR-T 270: Tension wheel (1)</b> (wear part)	<b>1821.047.048</b>
<b>OR-T 460: Tension wheel (1)</b> (wear part)	<b>1821.047.052</b>
Radial grooved ball bearing, Ø35/47x7 (2)	1930.180.356
Torx cylinder head screws, M4 (6)	1821.027.063
Torx cylinder head screws, M4x12 (4)	1913.904.164
Wire brush (8)	1821.901.004

### Removal

- ▶ Operate the trigger.
- ▶ Remove the battery as soon as the tensioning unit is open.
- ▶ Undo the two Torx cylinder head screws (6) and remove the strap guide, internal, rear (7) and the side cover (5).
- ▶ Undo the three Torx cylinder head screws (4) and remove the tension wheel cover (3).
- ▶ Carefully pull out the tension wheel (1).
- ▶ Detach the grooved ball bearing (2) from the tension wheel (1).

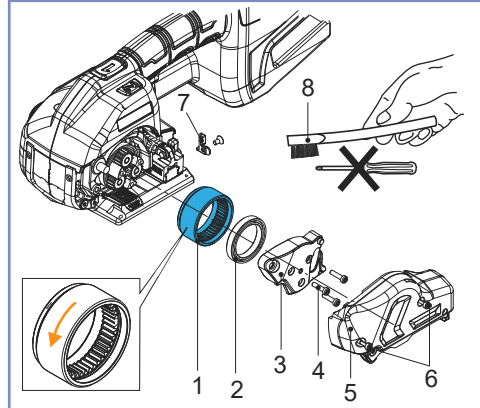

### WARNING

Make sure you are wearing safety goggles before cleaning with compressed air!

- ▶ Clean the tension wheel (1) with compressed air.
- ▶ If the teeth are heavily contaminated:  
Carefully clean the tension wheel with a wire brush (8).
- ▶ Check the tension wheel for worn teeth. If any of the teeth are worn, replace the tension wheel.



### ATTENTION

The tension wheel must not rotate during cleaning. Risk of broken teeth!

### Installation

- ▶ Installation is carried out in reverse order. Observe the tension wheel's direction of rotation (1), see arrow.
- ▶ Lightly grease the tension wheel's internal teeth with Klüber grease GBU Y 131 (Microlube).

**ULINE**

1-800-295-5510  
uline.com

## 6.5 Cleaning/replacing the tooth plate

Required parts	Order number
OR-T 140/OR-T 270: Tooth plate (2) (wear part)	1821.048.038
OR-T 460: Tooth plate (2) (wear part)	1821.048.042
Torx cylinder head screw (1) M4x6	1913.904.064
Wire brush (3)	1821.901.004

### Removal

- ▶ Operate the trigger.
- ▶ Remove the battery as soon as the tensioning unit is open.
- ▶ Undo the Torx cylinder head screw (1).
- ▶ Remove the tooth plate (2).



#### WARNING

Make sure you are wearing safety goggles before cleaning with compressed air!

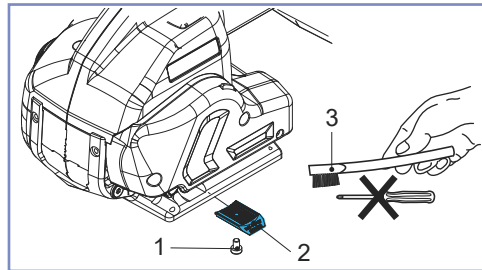

- ▶ Clean the tooth plate (2) with compressed air.
- ▶ If the teeth are heavily contaminated: Carefully clean the tooth plate with a wire brush (3).
- ▶ Check the tooth plate for worn teeth. If any of the teeth are worn, replace the tooth plate.

### Installation

- ▶ Installation is carried out in reverse order. Lock the flat head screw (1) with Loctite® 222.
  - The tooth plate (2) is firmly screwed to the base plate.

**ULINE**

1-800-295-5510  
uline.com

## 6.6 Replacing the knife

Required parts	Order number
<b>OR-T 140/OR-T 270: Knife (3)</b> (wear part)	<b>1821.209.050</b>
<b>OR-T 460: Knife (3)</b> (wear part)	<b>1821.209.054</b>
Torx cylinder head screw, M4 (2)	1821.027.063
Torx cylinder head screw, M4x12 (5)	1913.904.125
Collar bushing (4)	1832.022.238



### CAUTION Cutting injury!

Do not touch the knife's blade (3).

### Removal

- ▶ Remove the rechargeable battery from the device.
- ▶ Undo the two cylinder head screws (2) and remove the strap guide, internal, rear (7) and the cover (2).
- ▶ Undo the cylinder head screw (5), remove and replace the knife (3) with the collar bushing (4).

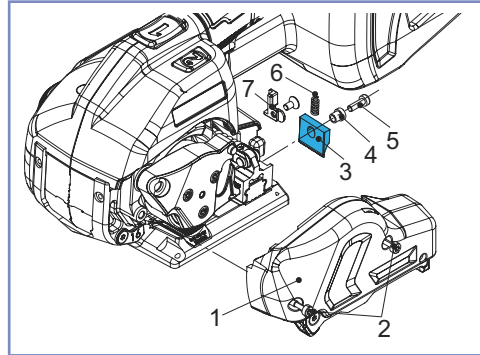

### Installation

- ▶ Installation is carried out in reverse order.
- ▶ Before installing the knife (3), check whether the pressure spring (6) is inserted above the knife.
- ▶ Lock the cylinder head screw (5) with Loctite® 222.

## 6.7 Resetting the device

Tools required	Order number
Torx screwdriver T20 (1)	---



### ATTENTION

The device may only be reset if the welding device is blocked.

- ▶ Remove the rechargeable battery from the device.
- ▶ Insert the Torx T20 screwdriver (1) into the cylinder head screw at the back (see red arrow).
- ▶ **Working in a clockwise direction, complete ten full rotations.** Only a little force is needed for this (do not use a cordless electric screwdriver for this).
- ▶ Operate the trigger (2).
  - The welding unit mechanism must now swivel up.

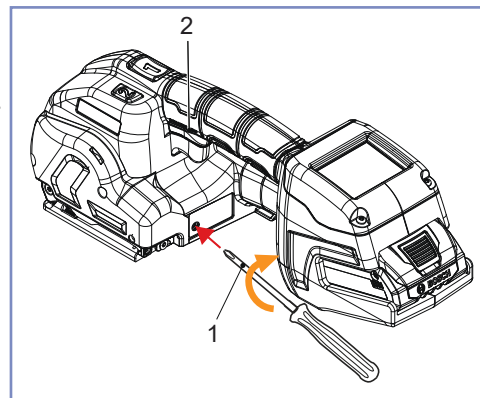

If you were unable to reset the device, please contact the service department!



































**ULINE**

1-800-295-5510  
uline.com

## 6.8 Eliminating faults











If certain faults arise, the control panel background lighting and the error display (symbol + code) light up, and an acoustic signal also sounds.

If the error continues to exist (is not reset automatically), rectify the problem by removing/inserting the rechargeable battery.

Display/state	Cause/error	Rectification
Control panel is not responding + 	<ul style="list-style-type: none"> <li>Key lock is switched on.</li> </ul>	<ul style="list-style-type: none"> <li>Switching off the key lock: see chapter 4.6.</li> </ul>
Display is dark.	<ul style="list-style-type: none"> <li>Rechargeable battery is defective/completely flat.</li> <li>Rechargeable battery not inserted correctly.</li> </ul>	<ul style="list-style-type: none"> <li>Charge/replace the rechargeable battery.</li> <li>Check whether the battery is fully inserted and the release button is engaged.</li> </ul>
The  &  symbols flash.	<ul style="list-style-type: none"> <li>Battery temperature too low.</li> </ul>	<ul style="list-style-type: none"> <li>Resolves itself at higher battery temperature. Work is possible. Max. tensioning force has not been reached.</li> </ul>
E11, red display +   pulsing (long). symbol  flashes.	<ul style="list-style-type: none"> <li>The inserted battery is not permitted (invalid rechargeable battery type).</li> </ul>	<ul style="list-style-type: none"> <li>Insert the correct rechargeable battery.</li> <li>Contact the service department if the error keeps occurring.</li> </ul>
E20, red display +   pulsing (long). The  &  symbols flash.	<ul style="list-style-type: none"> <li>Battery too hot (&gt; 60°).</li> </ul>	<ul style="list-style-type: none"> <li>Let the rechargeable battery cool down.</li> <li>Use another rechargeable battery.</li> </ul>
E21, red display +   pulsing (long). The  &  symbols flash.	<ul style="list-style-type: none"> <li>Battery temperature too low. (Battery below temperature).</li> </ul>	<ul style="list-style-type: none"> <li>Heat up the rechargeable battery.</li> <li>Use another rechargeable battery.</li> </ul>
E23 (E27, E34), red display +   pulsing (long). symbol  flashes.	<ul style="list-style-type: none"> <li>Battery undervoltage limit reached.</li> <li>Rechargeable battery empty.</li> </ul>	<ul style="list-style-type: none"> <li>Charge the rechargeable battery.</li> <li>Use another rechargeable battery.</li> </ul>
E24, red display +   pulsing (long). symbol  flashes.	<ul style="list-style-type: none"> <li>Rechargeable battery not inserted correctly.</li> <li>Wrong rechargeable battery.</li> </ul>	<ul style="list-style-type: none"> <li>Insert the rechargeable battery quickly, clean the contacts.</li> <li>Use another rechargeable battery.</li> </ul>
E25, red display +   pulsing (long). The  &  symbols flash.	<ul style="list-style-type: none"> <li>Rechargeable battery not inserted correctly.</li> <li>Defective temperature sensor.</li> </ul>	<ul style="list-style-type: none"> <li>Insert the rechargeable battery quickly, clean the contacts.</li> <li>Use another rechargeable battery.</li> </ul>
E33 red display +   pulsing (long). symbol  flashes.	<ul style="list-style-type: none"> <li>Electronics overtemperature.</li> <li>Control unit too hot.</li> </ul>	<ul style="list-style-type: none"> <li>Let the device cool down.</li> <li>Contact the service department if the error keeps occurring.</li> </ul>
E50 (E51), orange display +   pulsing (long). The  &  symbols appear.	<ul style="list-style-type: none"> <li>Cancel the welding or cooling process by operating the trigger.</li> <li>Attention: Seal quality!</li> </ul>	<ul style="list-style-type: none"> <li>Repeat strapping.</li> </ul>
E53 (E54), red display +   pulsing (long). The  &  symbols appear.	<ul style="list-style-type: none"> <li>Welding start time-out.</li> <li>Foreign body in the device.</li> </ul>	<ul style="list-style-type: none"> <li>Reset the device</li> <li>Contact the service department if the error keeps occurring.</li> </ul>

**ULINE**

1-800-295-5510  
uline.com

Display/state	Cause/error	Rectification
E55, orange display +   pulsing (moderate). The  &  &  symbols appear.	<ul style="list-style-type: none"> <li>• Power restriction.</li> <li>• Motor protection function.</li> <li>• Compressible packaged good?</li> </ul>	<ul style="list-style-type: none"> <li>▶ Check application.</li> <li>▶ Repeat the tensioning process.</li> </ul>
E56 (E60) orange display +   pulsing (moderate). symbol  appears.	<ul style="list-style-type: none"> <li>• Tensioning process time-out.</li> <li>• Motor protection function.</li> <li>• Maximum tensioning time exceeded.</li> </ul>	<ul style="list-style-type: none"> <li>▶ Check application.</li> <li>▶ Repeat the tensioning process.</li> </ul>
E57 orange display +   pulsing (moderate). symbol  appears.	<ul style="list-style-type: none"> <li>• Strap torn or slipped.</li> </ul>	<ul style="list-style-type: none"> <li>▶ Reduce the tensioning force.</li> <li>▶ Insert the strap again.</li> <li>▶ Clean or replace the tension wheel.</li> </ul>

If the error cannot be fixed by applying the measures described above → please contact the local service department! For other errors/error numbers not described here → please contact the local service department!

## 7 Technical data

	OR-T 140	OR-T 270	OR-T 460
Weight	3.8 kg (inc. battery)	4.0 kg (inc. battery)	4.2 kg (inc. battery)
Dimensions	Length 367 mm Width 149 mm Height 135 mm	Length 367 mm Width 149 mm Height 135 mm	Length 367 mm Width 152 mm Height 138 mm
Tensioning force	PET 400–1200 N PP 150–750 N	PET 900–2500 N PP 400–1360 N	PET 1300–4500 N PP 400–1600 N
Tensioning speed	0–180 mm/s	0–220 mm/s	0–150 mm/s
Sealing type	Friction welding sealing		
A-rated sound pressure level	L <sub>pA</sub> 74 dB (A) K <sub>pA</sub> 3 dB		
Measurement uncertainty K			
A-rated sound power level	L <sub>WA</sub> 85 dB (A) K <sub>WA</sub> 3 dB		
Measurement uncertainty K			
Total vibration value*	a <sub>h</sub> ≤ 2.5 m/s <sup>2</sup> K 1.5 m/s <sup>2</sup>		
Measurement uncertainty K			
Measured values determined according to EN 60745-1:2009			
Usage temperature for strapping device	-10 °C to +40 °C		
Relative humidity	Up to 90 %		

CHARGER/BATTERY	OR-T 140	OR-T 270	OR-T 460
	Operation and storage at ambient temperatures from -20 °C to +50 °C Charging at ambient temperatures from 0 °C to +35 °C		
Charger voltage	100/110/230 V	100/110/230 V	100/110/230 V
Charger type	BOSCH GAL 1840 CV	BOSCH GAL 1840 CV	BOSCH GAL 1840 CV
Charging time	48 min = approx. 80 % 65 min = approx. 100 %	48 min = approx. 80 % 65 min = approx. 100 %	48 min = approx. 80 % 65 min = approx. 100 %
Cycles per battery charge			
■ Low tension	1000	800	800
■ Medium tension	800	600	500
■ High tension	600	400	300
Battery type	Bosch Li-Ion 18 V, 4.0 Ah	Bosch Li-Ion 18 V, 4.0 Ah	Bosch Li-Ion 18 V, 4.0 Ah

For rechargeable battery and charger, see separate operating instructions



\* see chapter 2.4, Vibration load

Continued on the next page

**ULINE**

1-800-295-5510  
uline.com

Continuation:

	OR-T 140	OR-T 270	OR-T 460
<b>PLASTIC STRAP</b>			
Strap quality	Polyester (PET) Polypropylene (PP)	Polyester (PET) Polypropylene (PP)	Polyester (PET) Polypropylene (PP)
Strap width adjustable to	9–10, 12–13 mm	12–13, 15–16 mm	15–16, 18–19 mm
Strap thickness	0.4–0.8 mm (PET) 0.5–0.8 mm (PP)	0.5–1.0 mm	0.8–1.3 mm

## 8 **EC Declaration of Conformity (copy)**

(Machinery Directive 2006/42/EC, Annex II 1.A)

We declare under our sole responsibility that the machine to which this declaration refers complies with the applicable provisions of the Machinery Directive (2006/42/EC) and its amendments. Furthermore, conformity with the applicable provisions of the EMC Directive (2014/30/EU) applies.

Considered harmonized standards: EN 60745-1:2009 + A11:2010; EN 60745-2-18:2009;  
EN ISO 12100:2010; EN 61000-6-2:2005+AC:2005  
EN 61000-6-3:2007+A1:2011+AC:2012

Other standards considered: IEC 61000-6-2:2016; IEC 61000-6-3:2020; EN 62233:2008

CB test certificate: NL-110883  
Certification body: DEKRA Certification B.V.  
Meander 1051, NL-6825 MJ Arnhem, Netherlands

Type designations: OR-T 140, OR-T 270, OR-T 460  
From machine no. / production year: A/24085001 / 2024 - B/24085001 / 2024 - C/24085001 / 2024

CH-8953 Dietikon, 16/09/2024



R. Siegrist  
Managing Director



A. Keller  
Director of Engineering, R&D  
Signode Technologies

Representative authorised to publish technical documents:  
Signode Switzerland GmbH, Silberstrasse 14, 8953 Dietikon 1, Switzerland

### **Manufacturer**

Orgapack  
c/o Signode Switzerland GmbH  
Silberstrasse 14  
Postfach 595

8953 Dietikon 1, SWITZERLAND  
www.orgapack.com

**ULINE**

1-800-295-5510  
uline.com