

# ULINE H-1273 STAINLESS STEEL TENSIONER

1-800-295-5510  
uline.com

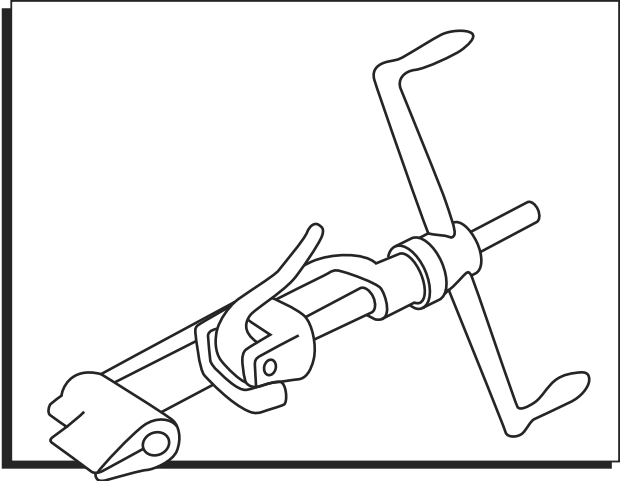

## INSTRUCTIONS



**CAUTION:** Always wear safety goggles while using tensioner.

1. Slide buckle on band, bringing end of band around object to be clamped and again through buckle. (See Figure 1)

Figure 1



2. Wrap band around object once more and again through the buckle. Double banding develops a great deal more radial compression than single banding. Bend end of band under buckle. (See Figure 2)

Figure 2

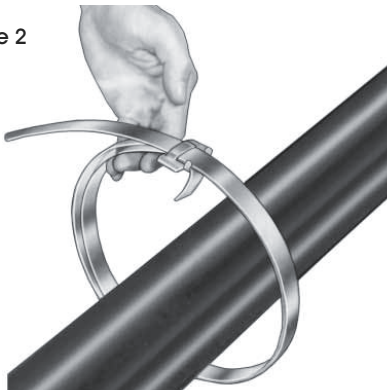

3. Place band in the open slot of tool nose and slide in. With thumb on band gripper lever, turn wing handle of tool clockwise to apply tension. Release gripper lever (gripper lever locks itself under tension). (See Figure 3)

Figure 3

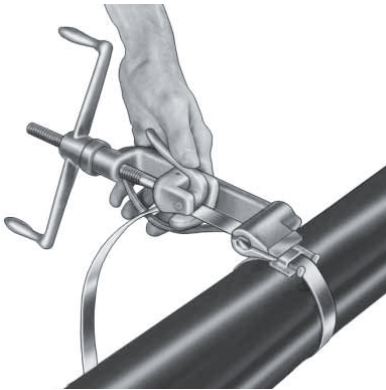

4. Place a finger on the band at the buckle bridge while turning (tensioning) wing handle. When you feel the band stop moving through the buckle, stop turning the handle. (See Figure 4)

Figure 4



## INSTRUCTIONS CONTINUED

5. With the band still in the tool, roll tool over buckle and turn wing handle counter clockwise throughout the entire rolling operation. (See Figure 5)

 **NOTE:** Failure to loosen tension with wing handle throughout entire course of roll may cause band to break.

Figure 5



6. Pull cutting handle to cut the band. (See Figure 6).

Figure 6

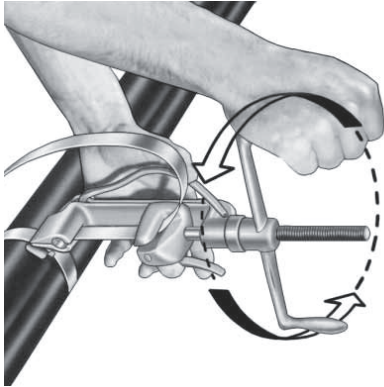
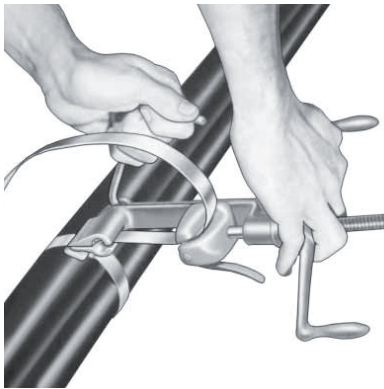

7. Hold down the stub of the band with your thumb and remove tool. (See Figure 7)

Figure 7

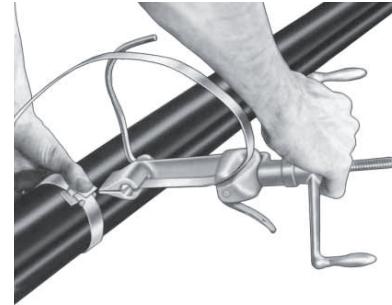

8. Clinch stub in place by hammering down buckle ears. Clamp is now complete. (See Figure 8)

Figure 8

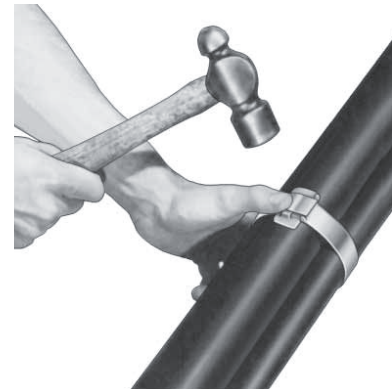

**ULINE H-1273**  
**TENSIONADORA**  
**DE ACERO**  
**INOXIDABLE**

800-295-5510  
uline.mx

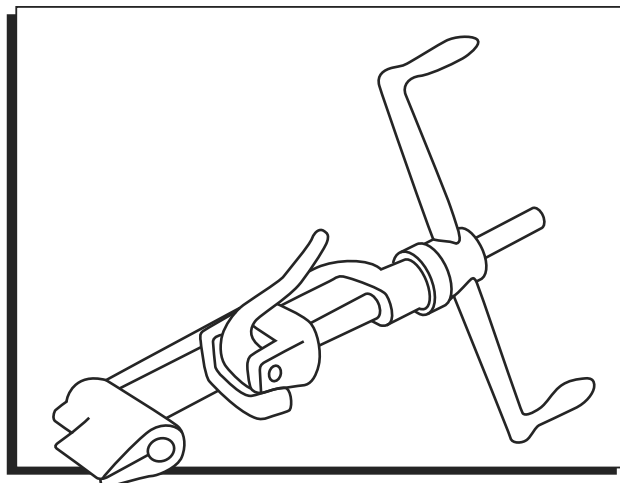

**INSTRUCCIONES**



**PRECAUCIÓN:** Utilice siempre lentes de protección cuando utilice la tensionadora.

1. Deslice la hebilla a través de la banda, enrollando el extremo de la banda alrededor del objeto que desea sujetar y de nuevo a través de la hebilla. (Vea Diagrama 1)

Diagrama 1



2. Enrolle la banda alrededor del objeto una vez más y de nuevo a través de la hebilla. Enrollar la banda dos veces ejerce una compresión radial mucho mayor que si la enrolla una sola vez. Doble el extremo de la banda por debajo de la hebilla. (Vea Diagrama 2)

Diagrama 2



3. Coloque la banda en la ranura abierta de la punta de la herramienta y deslícela para insertarla. Con el pulgar colocado sobre la palanca de agarre de la banda, gire el asa alada de la herramienta en el sentido de las agujas del reloj para aplicar presión. Libere la palanca de agarre (la palanca de presión se traba cuando se somete a presión). (Vea Diagrama 3)

Diagrama 3

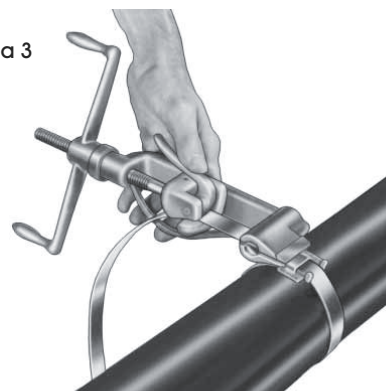

4. Coloque un dedo sobre la banda a la altura del puente de la hebilla mientras gira (tensionando) el asa alada. Cuando sienta que la banda deja de moverse a través de la hebilla, deje de girar el asa. (Vea Diagrama 4)

Diagrama 4

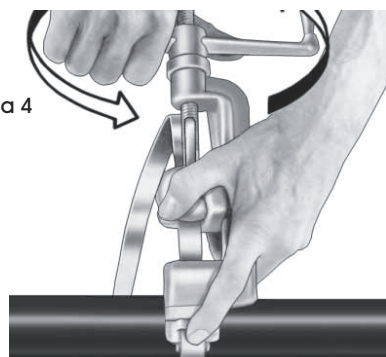

## CONTINUACIÓN DE INSTRUCCIONES

5. Con la banda todavía dentro de la herramienta, enrolle la herramienta por encima de la hebilla y gire el asa alada en el sentido contrario de las agujas del reloj durante toda la operación de enrollado. (Vea Diagrama 5)

 **NOTA:** Si no afloja la tensión con el asa alada durante el recorrido completo de enrollado es posible que la banda se rompa.

Diagrama 5



6. Jale del asa de corte para cortar la banda. (Vea Diagrama 6)

Diagrama 6

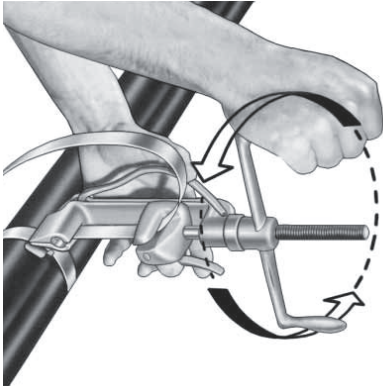
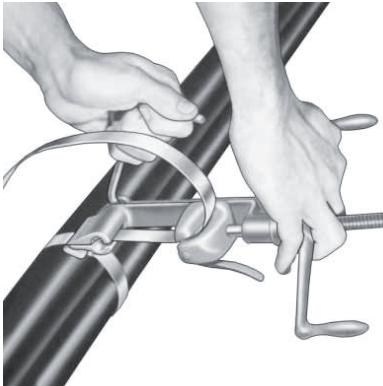

7. Mantenga presionado el extremo de la banda con el pulgar y quite la herramienta. (Vea Diagrama 7)

Diagrama 7

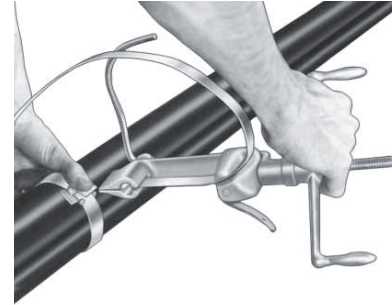

8. Sujete el extremo en su lugar golpeando con el martillo los salientes de la hebilla. La abrazadera está completamente colocada. (Vea Diagrama 8)

Diagrama 8

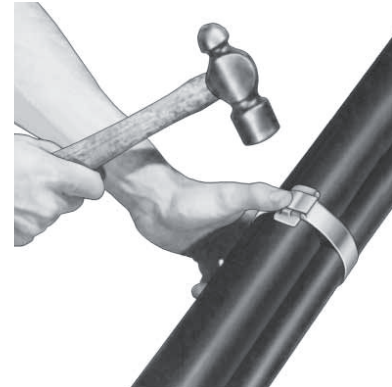

**ULINE**

800-295-5510  
uline.mx

**ULINE H-1273**  
**TENDEUR EN**  
**ACIER INOXYDABLE**

1-800-295-5510  
uline.ca

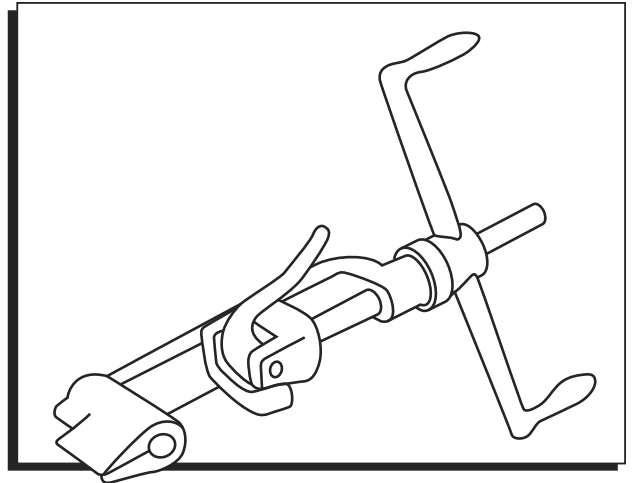

**INSTRUCTIONS**



**MISE EN GARDE :** Portez toujours des lunettes de sécurité lorsque vous utilisez un tendeur.

1. Glissez la boucle sur la bande, en amenant l'extrémité de la bande autour de l'objet à serrer, puis insérez-la dans la boucle. (Voir Figure 1)

Figure 1



2. Enroulez la bande autour de l'objet une fois de plus, et insérez-la de nouveau dans la boucle. Un doublage de bande générera une compression radiale plus importante qu'une bande simple. Pliez l'extrémité de la bande pour la sécuriser sous la boucle. (Voir Figure 2)

Figure 2



3. Placez la bande dans la fente ouverte du nez de l'outil et insérez-la. Avec le pouce contre le levier préhenseur de bande, tournez la poignée à ailes de l'outil dans le sens horaire pour appliquer une tension. Relâchez le levier préhenseur (il se verrouille lorsqu'il est sous tension). (Voir Figure 3)

Figure 3

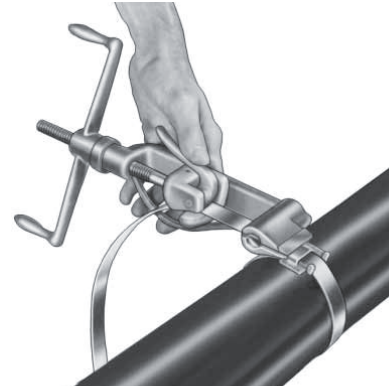

4. Placez un doigt sur la bande à l'entretoise de la boucle tout en tournant (tension) la poignée à ailes. Lorsque vous sentez que la bande ne bouge plus dans la boucle, arrêtez de tourner la poignée. (Voir Figure 4)

Figure 4





## INSTRUCTIONS SUITE

5. En maintenant la bande insérée dans l'outil, faites passer l'outil par-dessus la boucle et tournez la poignée à ailes dans le sens antihoraire pendant toute la procédure d'enroulement. (Voir Figure 5)

 **REMARQUE :** Si la poignée à ailes n'est pas utilisée pour relâcher la tension pendant la procédure d'enroulement, la bande risque de céder.

Figure 5



6. Tirez sur la poignée de coupe pour couper la bande. (Voir Figure 6)

Figure 6

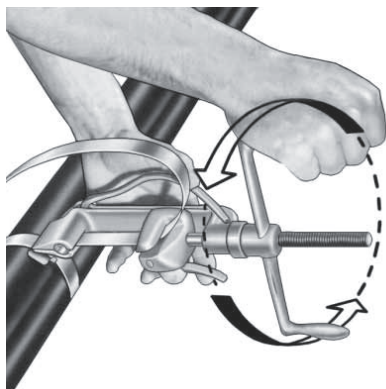
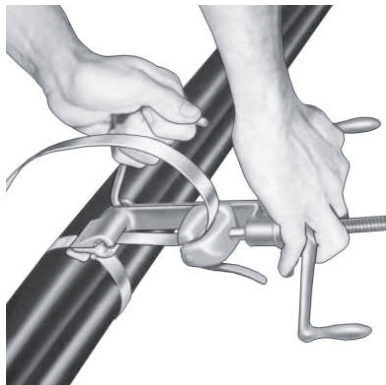

7. Maintenez le bout de la bande avec votre pouce et retirez l'outil. (Voir Figure 7)

Figure 7

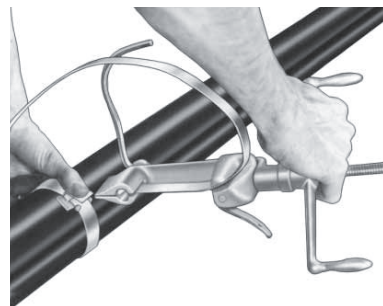

8. Fixez le bout en place en martelant les oreilles de la boucle. La fixation est maintenant achevée. (Voir Figure 8)

Figure 8

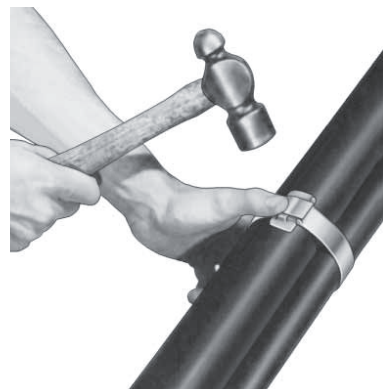

**ULINE**

1-800-295-5510  
uline.ca