

PARTS INCLUDED

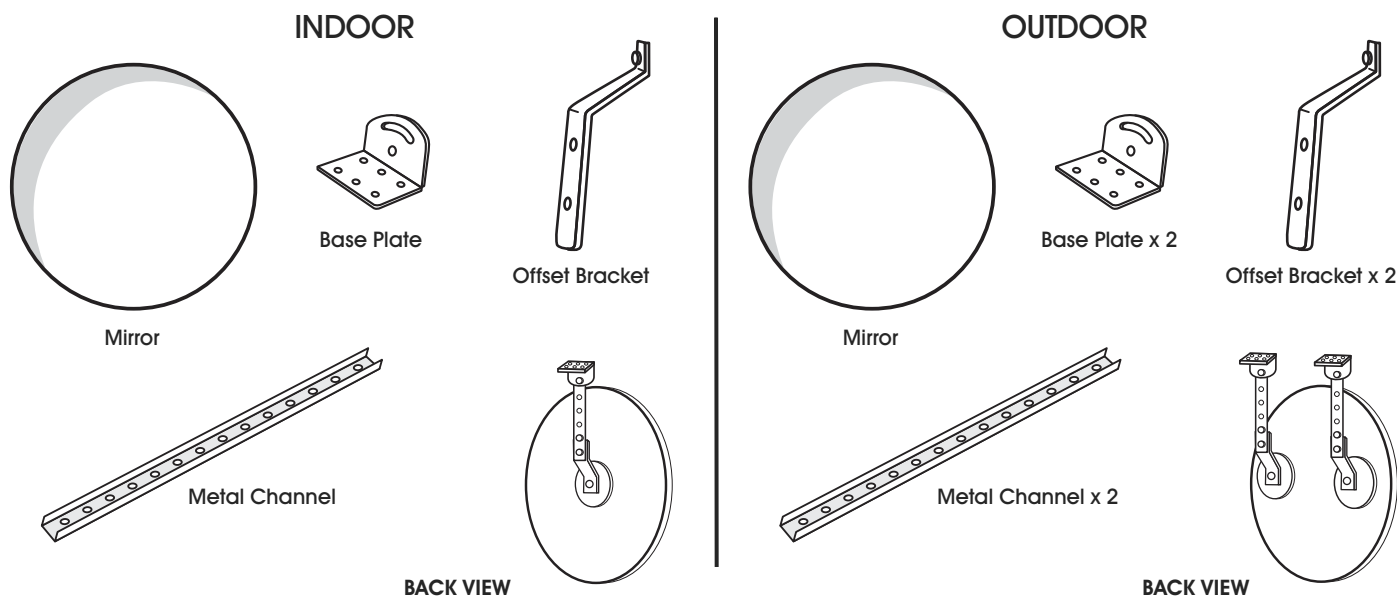

NOTE: Bolts, nuts, and washers for parts assembly included. Mounting hardware available separately.

ASSEMBLY INSTRUCTIONS

INSTALLING MIRROR ON WALL OR POST

1. Attach offset bracket to wall or post. (See Figure 1)
2. Attach mirror to offset bracket and adjust angle.
3. Tighten screws on ball bracket to fix mirror in desired position.
4. You may discard the metal channel and base plate.

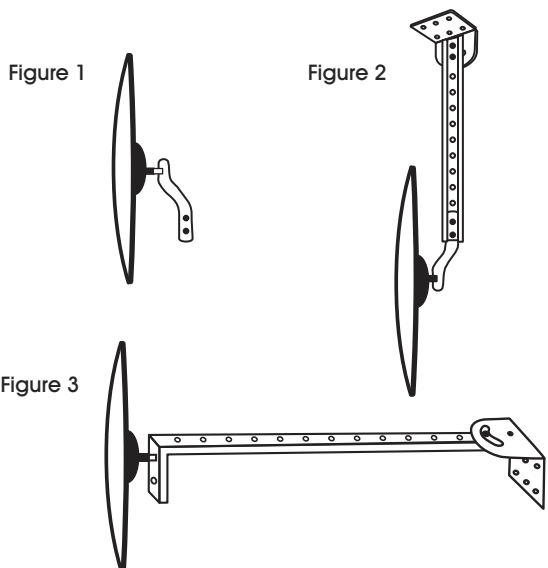

INSTALLING MIRROR ON COUNTER OR CEILING

1. Attach base plate to either counter or ceiling. (See Figure 2)
2. Attach metal channel to base plate (use nuts, bolts and washers).
3. Attach offset bracket to other end of channel (use nuts, bolts and washers).
4. Attach mirror to offset bracket.
5. Tighten screws on ball bracket to fix mirror in desired position.

INSTALLING MIRROR ON WALL WITH METAL CHANNEL

1. Attach base plate to wall. (See Figure 3)
2. Cut end of metal channel; bend to right angle.
3. Attach metal channel to base plate (use nuts, bolts and washers).
4. Attach mirror directly to metal channel. Offset bracket can be discarded.
5. Tighten screws on ball bracket to fix mirror in desired position.

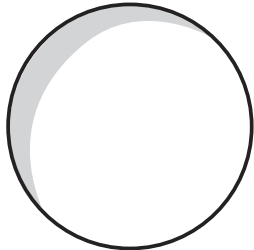
PARTES INCLUIDAS**INTERIORES**

Espejo

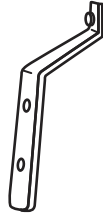
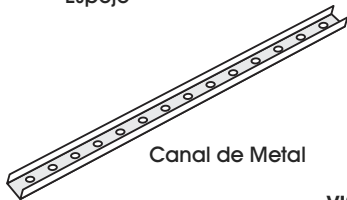

Placa de Base

Soporte
Sobresaliente

Canal de Metal

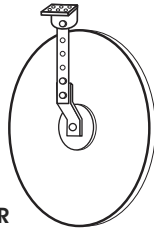

VISTA POSTERIOR

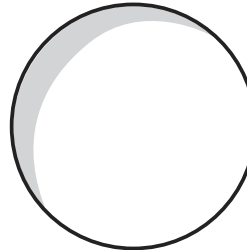
EXTERIORES

Espejo

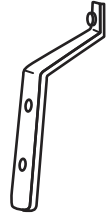
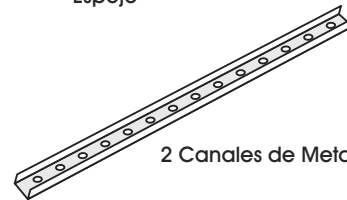

2 Placas de Base

2 Soporte
Sobresaliente

2 Canales de Metal

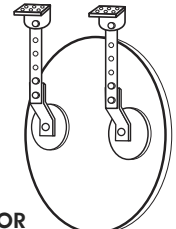

VISTA POSTERIOR



NOTA: Pernos, tuercas y rondanas para el ensamble de las partes incluidos. Accesorios de montaje disponibles por separado.

INSTRUCCIONES DE ENSAMBLE**INSTALAR EL ESPEJO EN UNA PARED O POSTE**

1. Fije el soporte sobresaliente a la pared o al poste. (Vea Diagrama 1)
2. Fije el espejo al soporte sobresaliente y ajuste el ángulo.
3. Apriete los tornillos del soporte de bola para fijar el espejo en la posición deseada.
4. Puede desechar el canal de metal y la placa de base.

Diagrama 1



Diagrama 2



Diagrama 3

**INSTALAR EL ESPEJO SOBRE UN MOSTRADOR O EN EL TECHO**

1. Fije la placa de base al mostrador o techo. (Vea Diagrama 2)
2. Fije el canal de metal a la placa de base (use tuercas, pernos y rondanas).
3. Fije el soporte sobresaliente al otro extremo del canal (use tuercas, pernos y rondanas).
4. Fije el espejo al soporte sobresaliente.
5. Apriete los tornillos del soporte de bola para fijar el espejo en la posición deseada.

INSTALAR EL ESPEJO EN LA PARED CON EL CANAL DE METAL

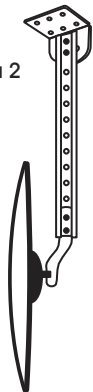
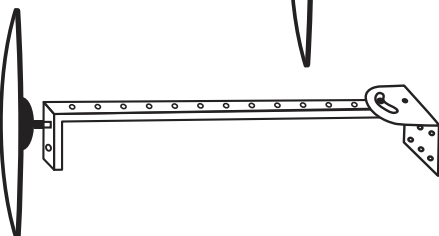
1. Fije la placa de base a la pared. (Vea Diagrama 3)
2. Corte el extremo del canal de metal; dóblelo en un ángulo recto.
3. Fije el canal de metal a la placa de base (use tuercas, pernos y rondanas).
4. Fije el espejo directamente al canal de metal. Puede desechar el soporte sobresaliente.
5. Apriete los tornillos del soporte de bola para fijar el espejo en la posición deseada.

PIÈCES COMPRISES

INTÉRIEUR

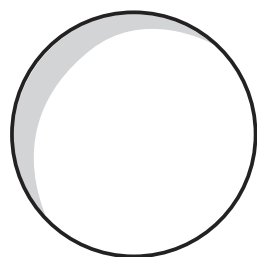

Miroir



Plaque d'assise

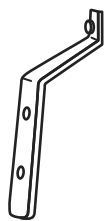

Support excentré

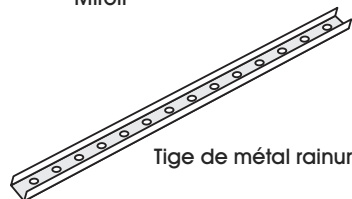

Tige de métal rainurée

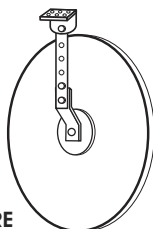

VUE ARRIÈRE

EXTÉRIEUR

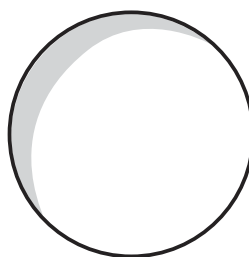

Miroir



Plaque d'assise x 2

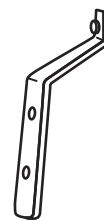

Support excentré x 2

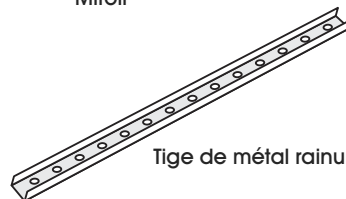

Tige de métal rainurée x 2

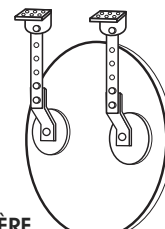

VUE ARRIÈRE



REMARQUE : Boulons, écrous et rondelles pour l'assemblage des pièces compris. Matériel d'installation offert séparément.

INSTRUCTIONS D'ASSEMBLAGE

INSTALLATION DU MIROIR AU MUR OU SUR UN MONTANT

1. Fixez le support excentré au mur ou montant. (Voir Figure 1)
2. Fixez le miroir au support excentré et réglez l'angle.
3. Serrez les vis sur le support de boule pour placer le miroir dans la position souhaitée.
4. Vous pouvez vous débarrasser de la tige de métal rainurée et de la plaque d'assise.

Figure 1

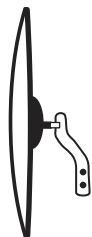
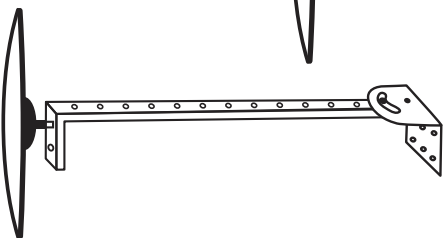

Figure 2



Figure 3



INSTALLATION DU MIROIR SUR UN COMPTOIR OU AU PLAFOND

1. Fixez la plaque d'assise au comptoir ou au plafond. (Voir Figure 2)
2. Fixez la tige de métal rainurée à la plaque d'assise (utilisez des écrous, des boulons et des rondelles).
3. Fixez le support excentré à l'autre extrémité de la tige de métal rainurée (utilisez des écrous, des boulons et des rondelles).
4. Fixez le miroir au support excentré.
5. Serrez les vis sur le support de boule pour placer le miroir dans la position souhaitée.

INSTALLATION DU MIROIR AU MUR AVEC LA TIGE DE MÉTAL RAINURÉE

1. Fixez la plaque d'assise au mur. (Voir Figure 3)
2. Coupez l'extrémité de la tige de métal rainurée, pliez à angle droit.
3. Fixez la tige de métal rainurée à la plaque d'assise (utilisez des écrous, des boulons et des rondelles).
4. Fixez le miroir directement sur la tige de métal rainurée. Vous pouvez vous débarrasser du support excentré.
5. Serrez les vis sur le support de boule pour placer le miroir dans la position souhaitée.