

ULINE H-251, H-252 PACKING RACK

1-800-295-5510
uline.com

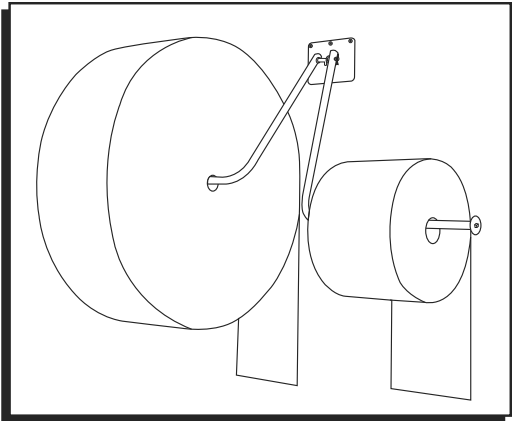

TOOLS NEEDED

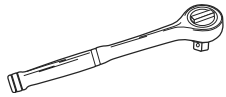

Ratchet Wrench



7/16" Socket

PARTS

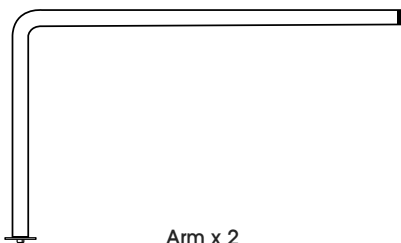

Arm x 2
(14½" for H-521)
(26½" for H-252)

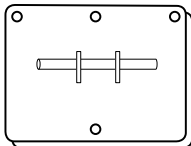

Back Plate x 1



Cotter Pin x 2



Washer x 8



M8 x 60 Hexhead
Lag Bolt x 4

ASSEMBLY

1. Mount back plate to wall with four hexhead lag bolts and washers. (See Figure 1)

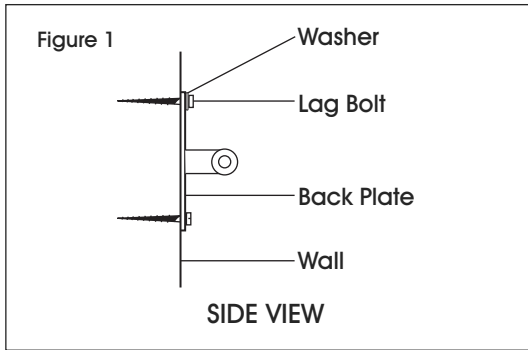

2. Align center mounting holes of back plate to a wall stud if possible. (See Figure 2)

 **NOTE:** A different type of wall mounting may be required depending on mounting surface.

3. Slide arms (facing out) over each side of the pivot pin placing a washer on either side. (See Figure 2)

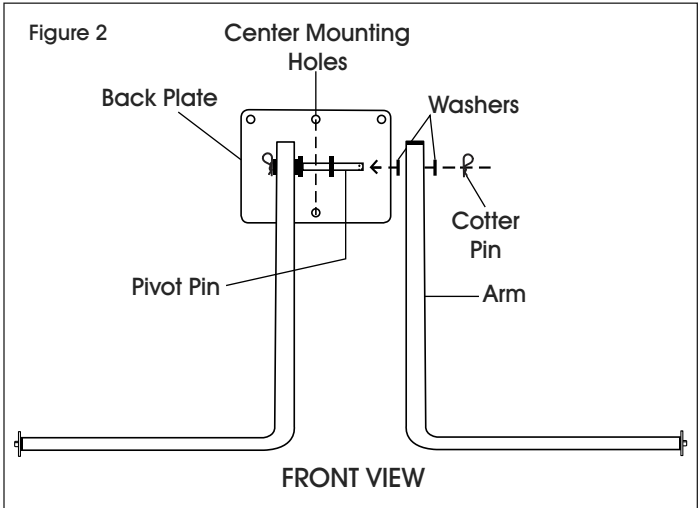

ASSEMBLY CONTINUED

4. Push cotter pins through holes at ends of pivot pin.
(See Figure 3)
5. Place bubble or foam roll over end of arm.

 **NOTE:** Roll must have a 2" minimum core.

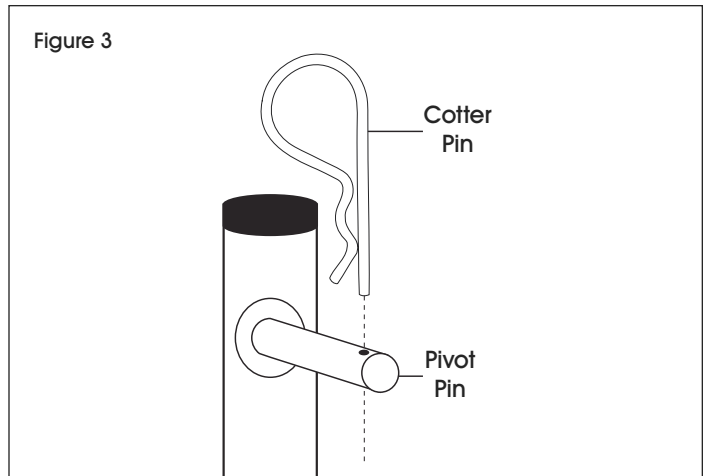

ULINE

1-800-295-5510
uline.com

ULINE H-251, H-252 PORTARROLLOS

800-295-5510
uline.mx

HERRAMIENTAS NECESARIAS

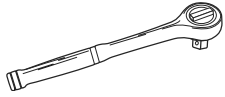

Trinquete



Llave de Dado
de 7/16"

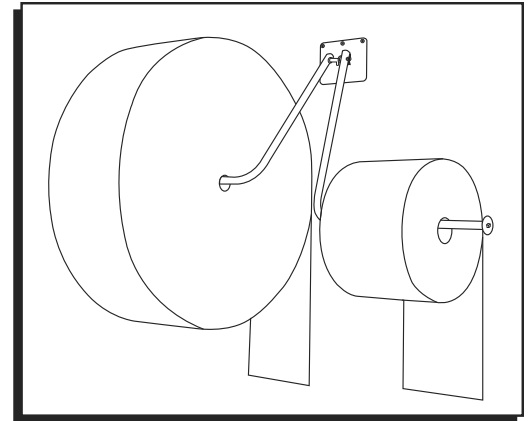

PARTES

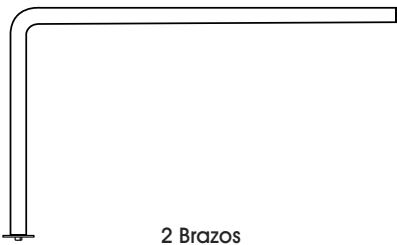

2 Brazos
(14½" para H-521)
(26½" para H-252)

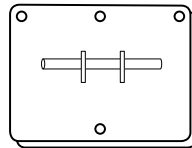

1 Placa
Posterior



2 Pasadores
de Chaveta



8 Rondanas

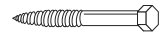

4 Tirafondos con Cabeza
Hexagonal M8 x 60

ENSAMBLE

1. Fije la placa posterior a la pared con cuatro tirafondos con cabeza hexagonal y rondanas. (Vea Diagrama 1)

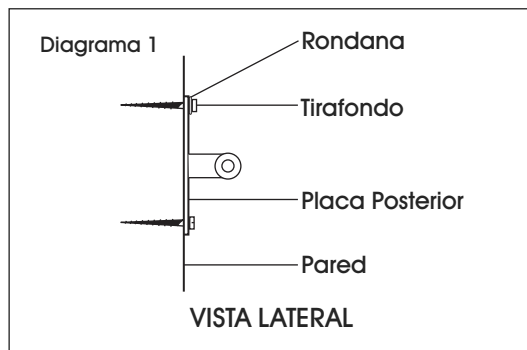

2. Alinee los orificios de montaje centrales de la placa posterior con una viga en la pared si es posible. (Vea Diagrama 2)



NOTA: Es posible que sea necesario otro tipo de montaje en pared dependiendo de la superficie de montaje.

3. Deslice los brazos (apuntando hacia afuera) por encima de cada uno de los lados del pasador giratorio, colocando una rondana en cualquiera de los lados. (Vea Diagrama 2)

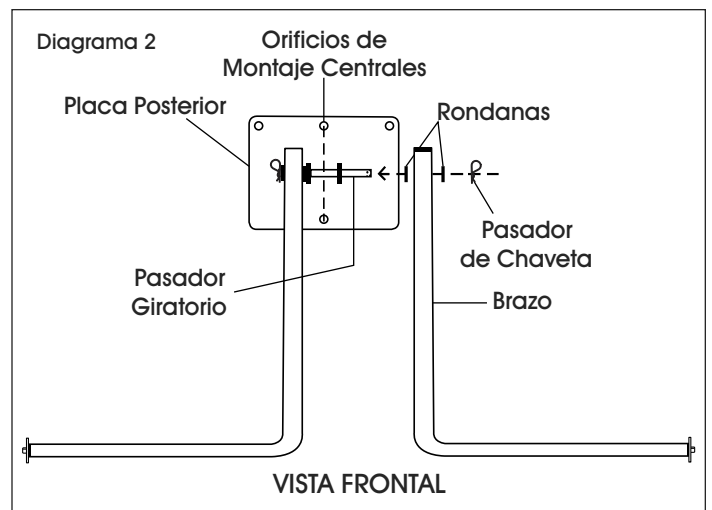

CONTINUACIÓN DE ENSAMBLE

4. Inserte pasadores de chaveta en los orificios de los extremos de los pasadores giratorios.
(Vea Diagrama 3)
5. Inserte un rollo de burbuja o de espuma a través del extremo del brazo.

 **NOTA:** El rollo deberá tener un núcleo de mínimo 5 cm (2").

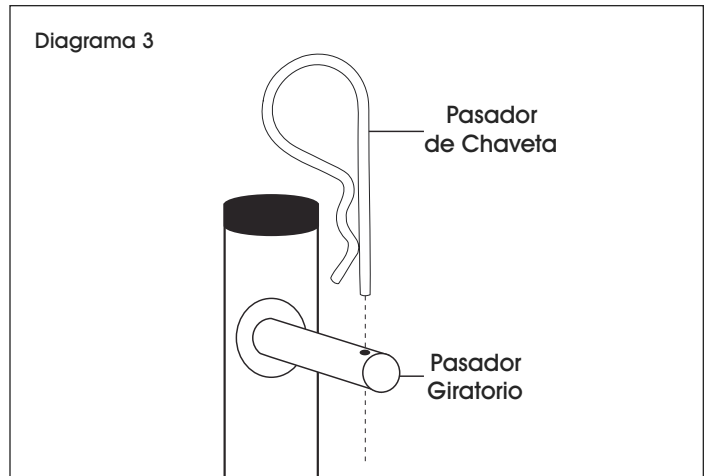

ULINE

800-295-5510
uline.mx

ULINE H-251, H-252

SUPPORT D'EMBALLAGE

1-800-295-5510
uline.ca

OUTILS REQUIS

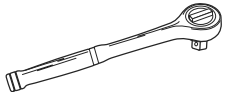

Clé à cliquet



Douille de 7/16 po

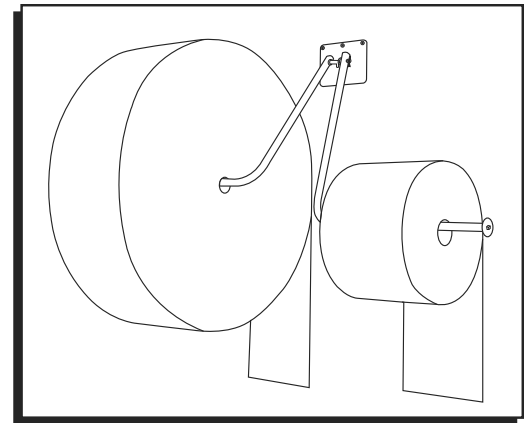

PIÈCES

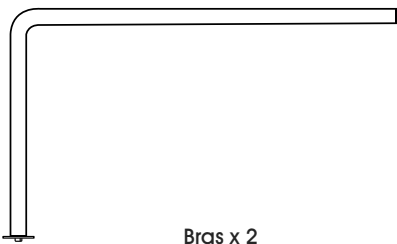

Bras x 2
(14 1/2 po pour H-521)
(26 1/2 po pour H-252)

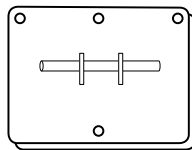

Plaque
arrière x 1



Goupille
fendue x 2



Rondelle x 8

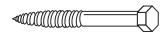

Tire-fond à tête
hexagonale
(M8 x 60) x 4

MONTAGE

- Fixez la plaque arrière au mur à l'aide de quatre tire-fond à tête hexagonale et rondelles. (Voir Figure 1)

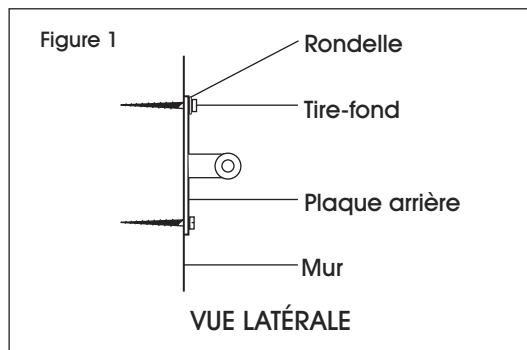

- Alignez les trous de fixation du centre de la plaque arrière avec un poteau mural si possible. (Voir Figure 2)

REMARQUE : Dépendamment de la surface de fixation, un autre type de matériel serait peut être nécessaire.

- Glissez les bras (vers l'extérieur) sur chaque extrémité de l'axe d'articulation en plaçant une rondelle de chaque côté. (Voir Figure 2)

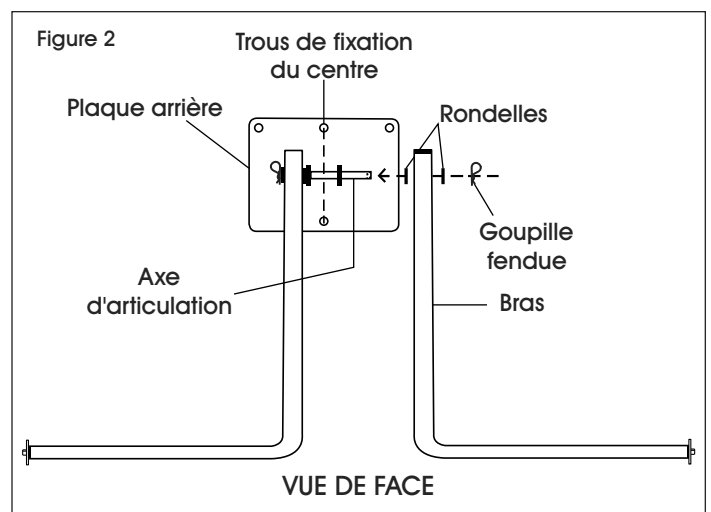

MONTAGE SUITE

4. Insérez les goupilles fendues à travers les trous aux extrémités de l'axe d'articulation. (Voir Figure 3)
5. Placez le rouleau de bulles ou de mousse sur l'extrémité du bras.



REMARQUE : Le rouleau doit avoir un mandrin d'au moins 5 cm (2 po).

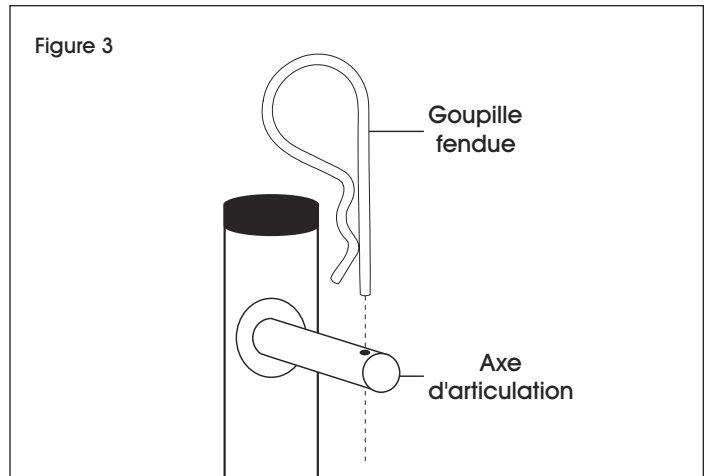

ULINE

1-800-295-5510
uline.ca