

**ULINE** H-1662, H-2897  
 H-2898, H-3491  
**DOG WASTE SYSTEM**

1-800-295-5510  
 uline.com

**RECOMMENDED TOOLS**

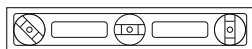

Level (optional)



7/16" Wrench

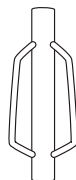

Post Hole Driver

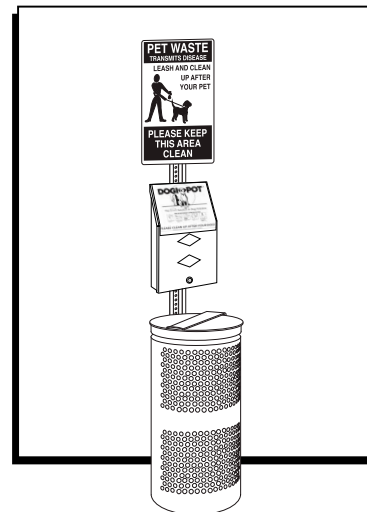

**PARTS**



Dog Waste System Sign, H-2898 x 1

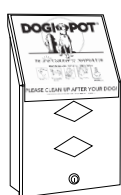

Dog Waste System Dispenser, H-2897 x 1

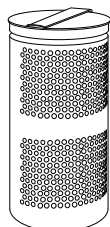

Dog Waste System Receptacle, H-3491 x 1



Key x 2  
 (Included with H-2897)

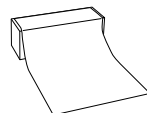

S-15585 Dog Waste Sample Bags x 2  
 (Included with H-2897)

**H-1662HDWR HARDWARE KIT**  
 (Included with H-2898 and H-3491)



Nut x 2



Washer x 2

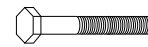

2 x 5/8" Bolt x 2

**H-2897 HARDWARE KIT**



Lock Nut x 2



Washer x 4



2 1/2 x 1/4" Bolt x 2



Dog Waste System Channel Post, H-1662 x 1

**ASSEMBLY**



**NOTE:** Dog Waste System is designed to mount to 2 x 2" steel square or channel post (hardware included). Recommend mounting to H-1662 8 ft. u-channel post. System can also be mounted to fence, wall or wood post (hardware not included).

1. Drive H-1662 post approximately 24" into ground at desired location. (See Figure 1)

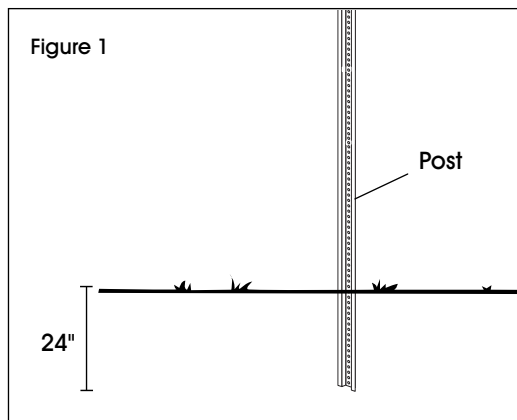

2. Mount waste receptacle to the lower section of post using the receptacle's pre-drilled holes and H-1662-HDWR hardware kit. (See Figure 2)

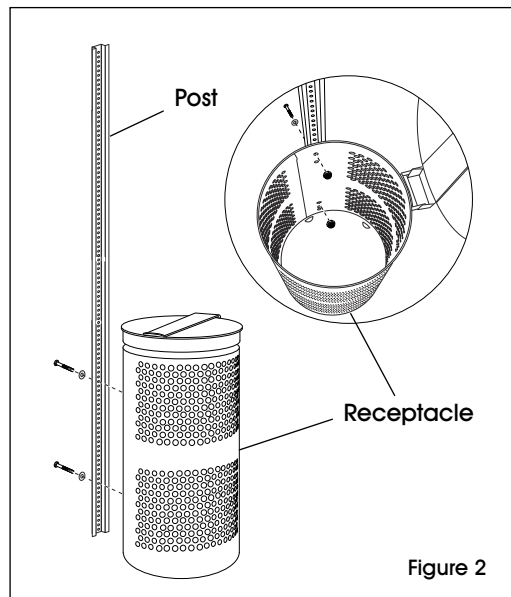

# ASSEMBLY CONTINUED

3. Remove the two keys from the back of the dispenser. Insert key into the lock on the front access panel and turn to unlock. Pull the lower part of the front access panel approximately 2" towards you and lift up to release and separate the front access panel from the body of the dispenser. (See Figure 3)

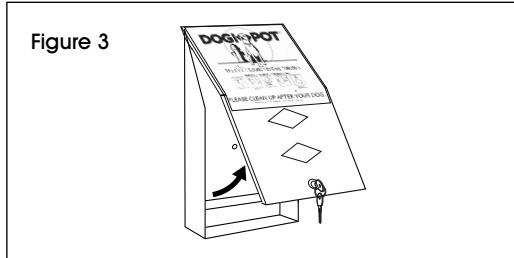

4. The dispenser has two pre-drilled holes through the back wall. Mount back wall of dispenser to steel post using the H-2897 hardware kit. (See Figure 4)

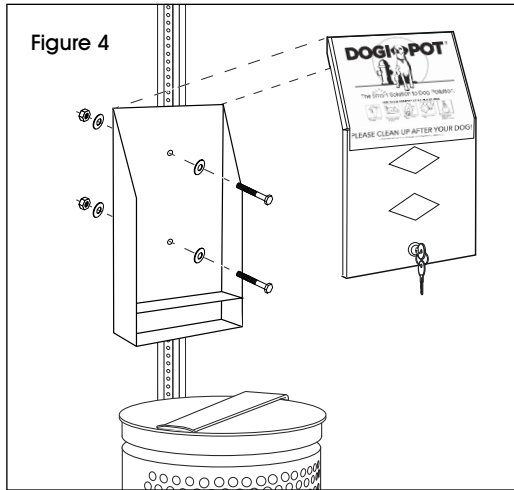

5. Fill dispenser with two boxed rolls (S-15585 dog waste sample bags). Place the two boxes on top of each other on the shelf of the dispenser with the opening of the boxes facing the front. Reinstall the front access panel and lock with the key. (See Figure 5)

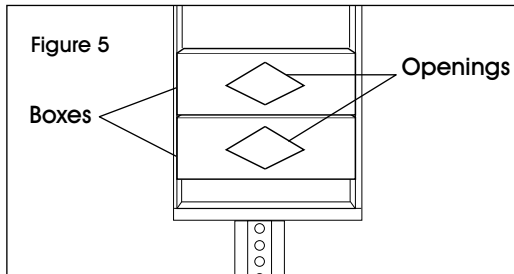

6. Reach through the two diamond-shaped openings and find the edges of the bags. Pull until the bags exit the dispenser. (See Figure 6)

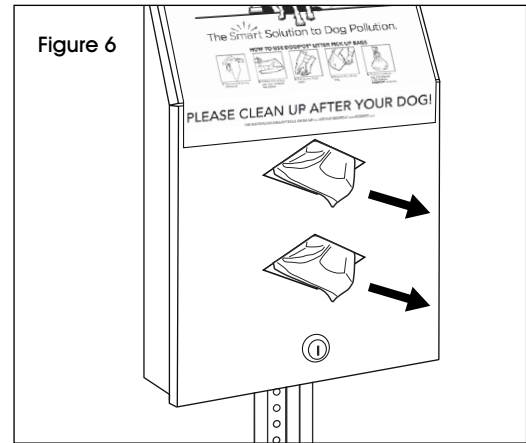

7. Mount optional sign to the top of the post using H-1662-HDWR hardware kit. (See Figure 7)

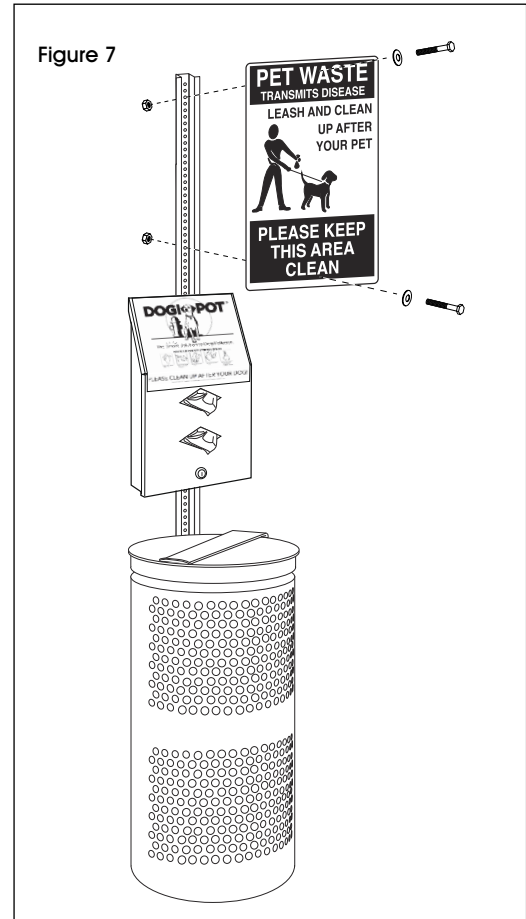

**ULINE**

1-800-295-5510

uline.com

# SISTEMA PARA DESECHOS

## HERRAMIENTAS SUGERIDAS

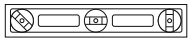

Nivel (opcional)

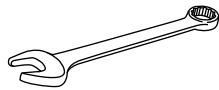

Llave de 7/16"



Conductor de Perforación para Poste



## PARTES



1 Letrero del Sistema para Desechos Caninos H-2898



1 Despachador del Sistema para Desechos Caninos H-2897

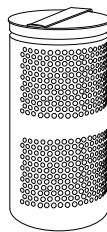

1 Despachador del Sistema para Desechos Caninos H-3491

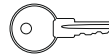

2 Llaves (Incluidas con H-2897)

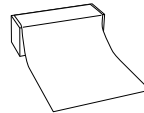

2 Muestras de Bolsas para Desechos Caninos S-15585 (Incluidas con H-2897)

### KIT DE TORNILLERÍA DEL H-1662-HDWR (Incluido con H-2898 y H-3491)



2 Tuercas



2 Rondanas

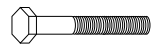

2 Pernos de 2" x 5/8"

### KIT DE TORNILLERÍA DEL H-2897



2 Tuercas de Seguridad Medianas



4 Rondanas

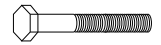

2 Pernos de 1/2" x 1/4"



1 Poste Canal del Sistema para Desechos Caninos H-1662

## ENSAMBLE

**NOTA:** El Sistema para Desechos Caninos está diseñado para instalarse en un poste cuadrado o poste canal de 2 x 2" (incluye tornillería). Se sugiere instalarlo al poste canal en u de 8 pies H-1662. Puede también instalar el sistema en una cerca, pared o poste de madera (no incluye la tornillería).

1. Introduzca el poste H-1662 aproximadamente 61 cm (24") en el suelo de la ubicación deseada. (Vea Diagrama 1)

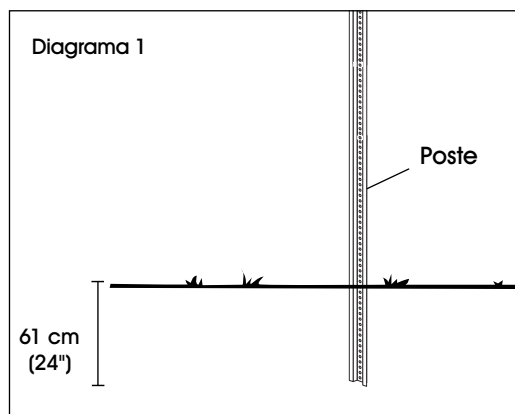

2. Instale el bote para desechos en la sección más baja del poste utilizando los orificios preperforados y el kit tornillería H-1662-HDWR. (Vea Diagrama 2)

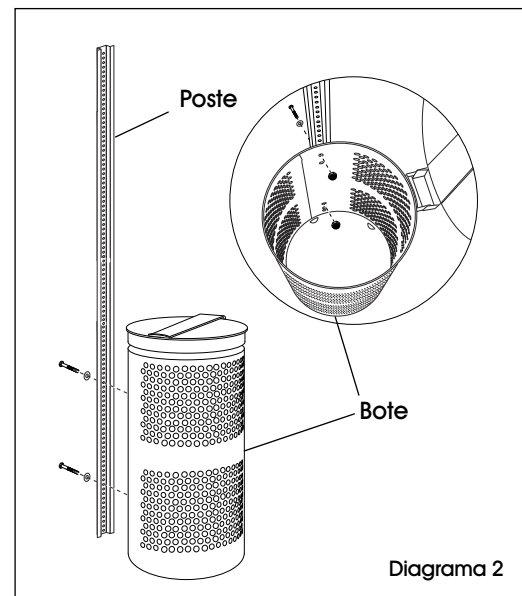

## CONTINUACIÓN DEL ENSAMBLE

3. Retire las dos llaves de la parte posterior del despachador. Inserte la llave en la chapa en el panel del acceso frontal y gírela para abrir. Jale la parte más baja del panel del acceso frontal aproximadamente 5 cm (2") hacia usted y levante para liberar y separar el panel del acceso frontal del cuerpo del despachador. (Vea Diagrama 3)

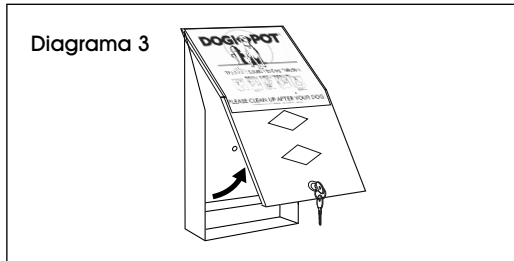

4. El despachador tiene dos orificios preperforados a través de la pared posterior. Instale la pared posterior del despachador al poste de acero utilizando el kit de tornillería H-2897. (Vea Diagrama 4)

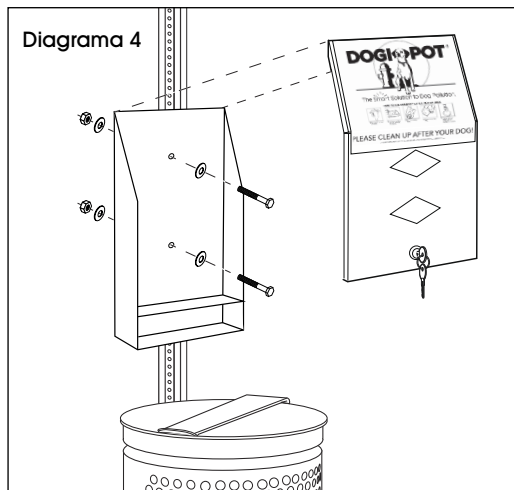

5. Llene el despachador con los dos rollos en caja (bolsas para desechos caninos S-15585). Coloque las dos cajas una sobre otra sobre la repisa del despachador con la abertura de las cajas orientadas al frente. Instale de nuevo el panel del acceso frontal y cierre con la llave. (Vea Diagrama 5)

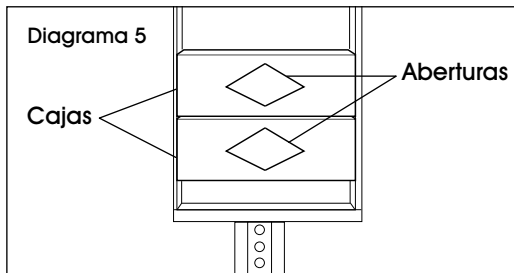

6. Busque a través de las aberturas con forma de diamante y encuentre la punta de las bolsas. Jale hasta sacar las bolsas del despachador. (Vea Diagrama 6)

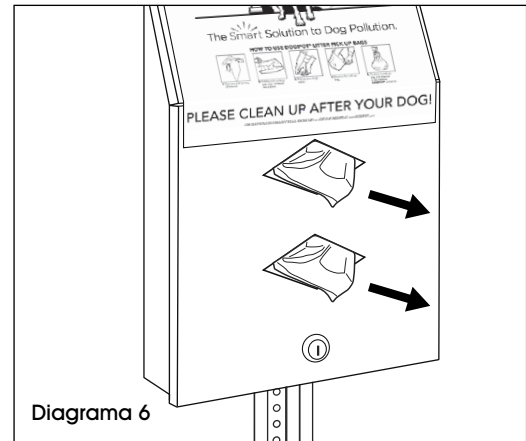

7. Instale el letrero opcional en la parte superior del poste utilizando el kit de tornillería H-1662-HDWR. (Vea Diagrama 7)

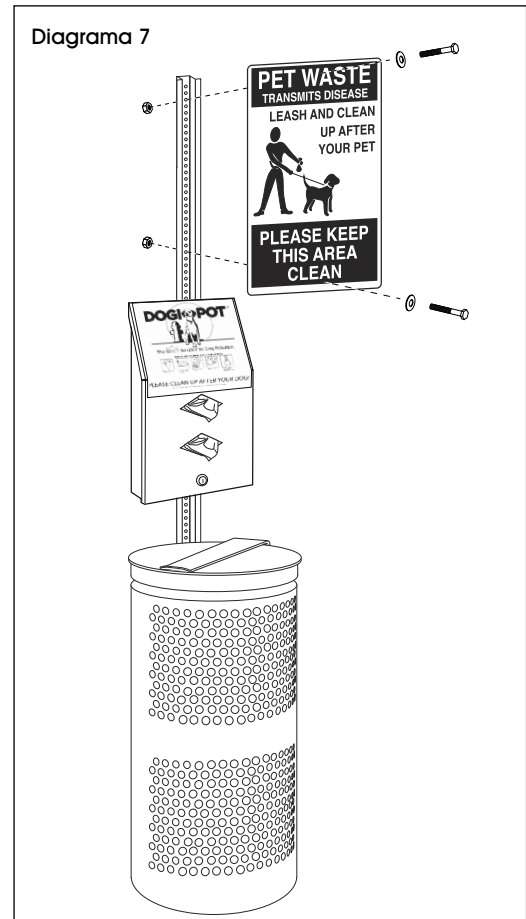

**ULINE**

800-295-5510  
uline.mx

# ULINE H-1662, H-2897 H-2898, H-3491

## SYSTÈME POUR DÉCHETS DE CHIENS

1-800-295-5510  
uline.ca

### OUTILS RECOMMANDÉS

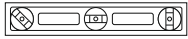

Niveau à bulles  
(Optionnel)



Clé de 7/16 po



Dispositif d'insertion  
de poteau



### PIÈCES



Enseigne pour  
système pour  
déchets de chien  
H-2898 x 1



Dévidoir pour  
système pour  
déchets de chien  
H-2897 x 1

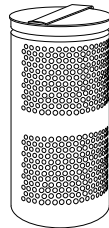

Réceptacle pour  
système pour  
déchets de chien  
H-3491 x 1

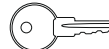

Clé x 2  
(inclus avec H-2897)

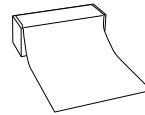

Échantillon de  
sacs à déchets de  
chien S-15585 x 2  
(inclus avec H-2897)

#### MATÉRIEL D'INSTALLATION POUR H-1662-HDWR (Inclus avec H-2898 et H-3491)



Écrou x 2



Rondelle x 2

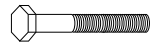

Boulon de 2 x 5/6  
po x 2

#### MATÉRIEL D'INSTALLATION POUR H-2897



Écrou de  
blocage x 2



Rondelle x 4

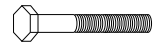

Boulon de  
2 1/2 x 1/4 po x 2

Poteau profilé en U pour système pour déchets de chien  
H-1662 x 1

### MONTAGE

**REMARQUE :** Le système pour déchets de chien est conçu pour être installé sur un poteau carré ou profilé en U en acier de 2 x 2 po (matériel d'installation inclus). Il est recommandé d'effectuer l'installation sur un poteau profilé en U de 8 pi H-1662. Le système peut également être installé au mur, ou à une clôture ou un poteau en bois (matériel d'installation non inclus).

1. Enfoncez le poteau H-1662 à environ 61 cm (24 po) dans le sol à l'emplacement désiré. (Voir Figure 1)

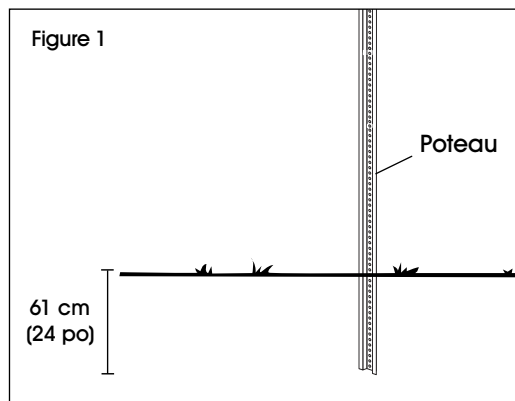

2. Installez le récipient pour déchets sur la section inférieure du poteau en utilisant les trous et le matériel d'installation H-1662-HDWR. (Voir Figure 2)

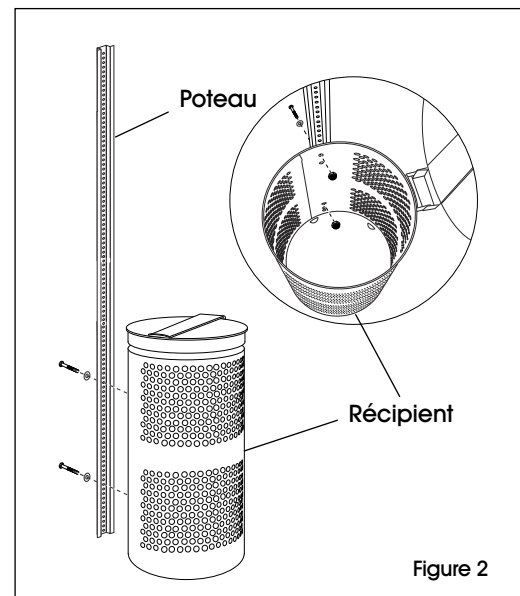

## MONTAGE SUITE

- Retirez les deux clés de l'arrière du distributeur. Insérez la clé dans la serrure située sur le panneau d'accès avant et tournez pour déverrouiller. Tirez vers vous la partie inférieure du panneau d'accès avant d'environ 5 cm (2 po) et soulevez-la pour la détacher du reste du distributeur. (Voir Figure 3)

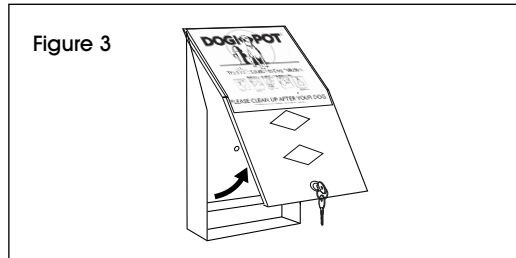

- Le panneau arrière du distributeur est doté de deux trous prépercés. Installez le panneau arrière du distributeur au poteau en acier à l'aide du matériel d'installation H-2897. (Voir Figure 4)

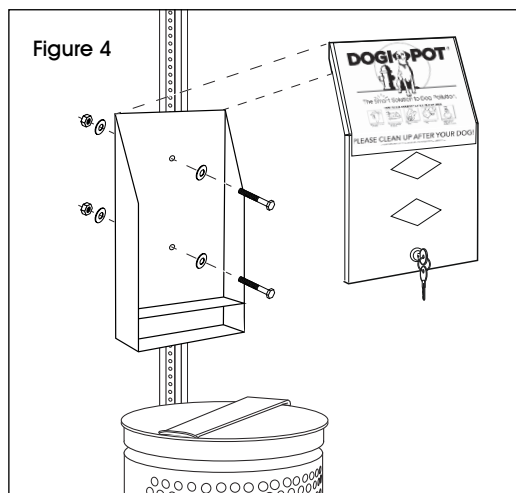

- Placez les deux boîtes de rouleaux (S-15585 échantillons de sacs pour déchets de chien) dans le distributeur. Superposez les deux boîtes à l'intérieur du distributeur, leur ouverture orientée vers l'avant. Remplacez le panneau d'accès avant et verrouillez à clé. (Voir Figure 5)

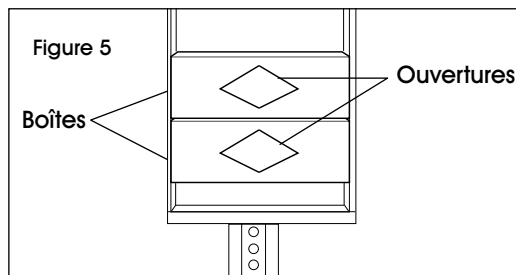

- Plongez la main à travers les deux ouvertures en losanges pour saisir le bord des sacs. Tirez les sacs jusqu'à ce qu'ils sortent du distributeur. (Voir Figure 6)

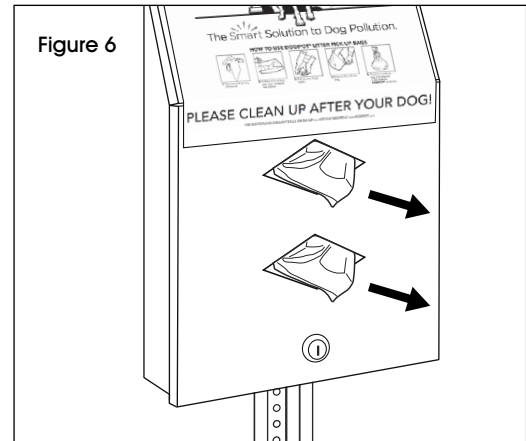

- Installez l'enseigne optionnelle en haut du poteau à l'aide du matériel d'installation H-1662-HDWR. (Voir Figure 7)

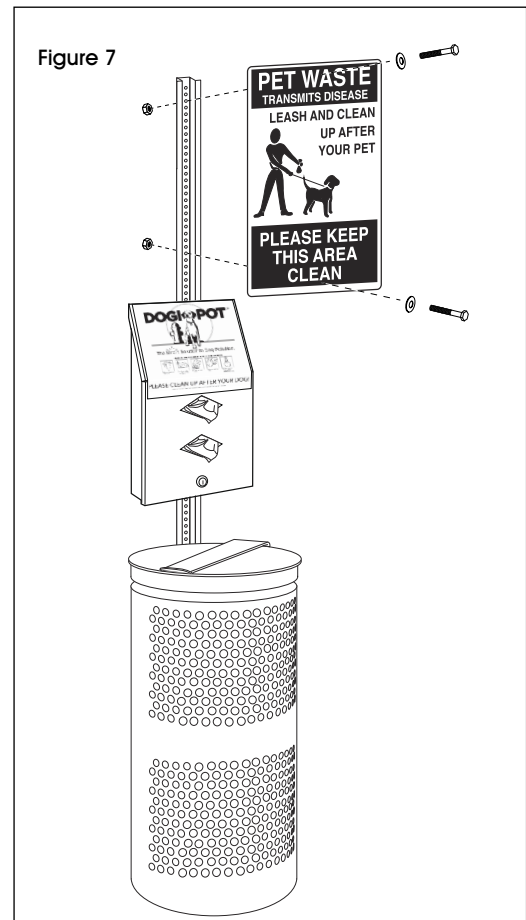

**ULINE**

1-800-295-5510  
uline.ca