

ULINE H-3040, H-3041 ENCLOSED CORK BOARD

1-800-295-5510
uline.com

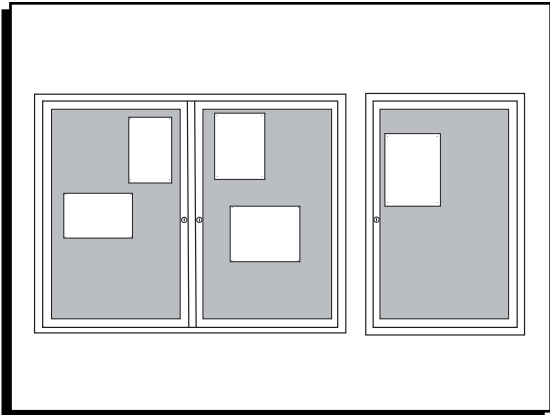

TOOLS NEEDED



Drill

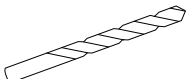

1/4" Drill Bit

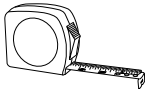

Tape Measure

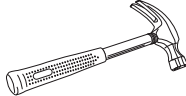

Hammer

PARTS

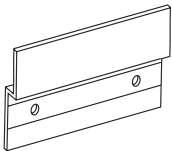

Hanging Bracket x 2

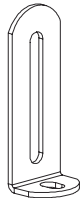

L-Bracket x 2



Drywall Anchor x 6

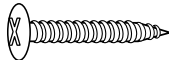

1 1/4" Screw x 6



1/4" Screw and Washer x 2

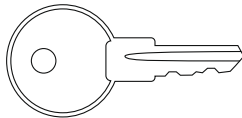

Key x 2

TOP HANGING BRACKET MOUNTING

1. Determine board location. Position top hanging brackets 6" from outside edge of board with bracket holes 2 3/4" from top of board. (See Figure 1)

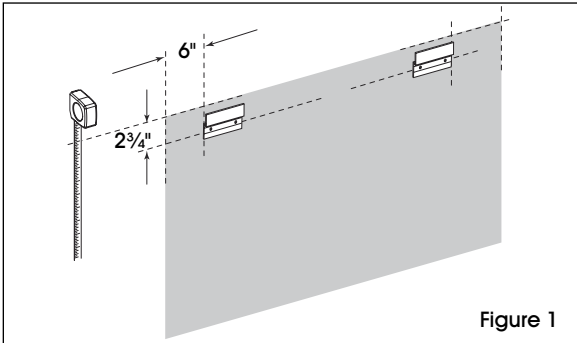

Figure 1

2. Mark wall at centers of bracket holes. (See Figure 2)
3. Drill holes for each bracket in marked locations using a 1/4" drill bit. (See Figure 3)

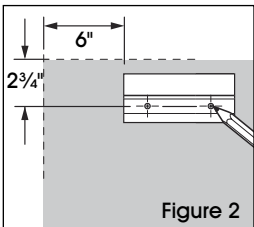

Figure 2

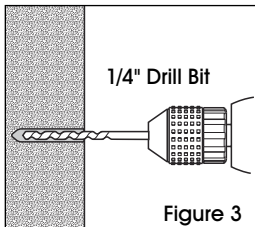

Figure 3

4. Insert wall anchors into holes, flush with the wall. Insert 1 1/4" screws through hanging brackets, into the wall anchors. Tighten firmly. (See Figure 4)

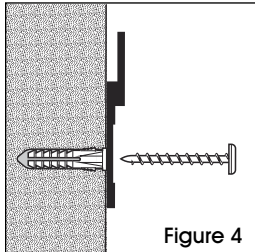
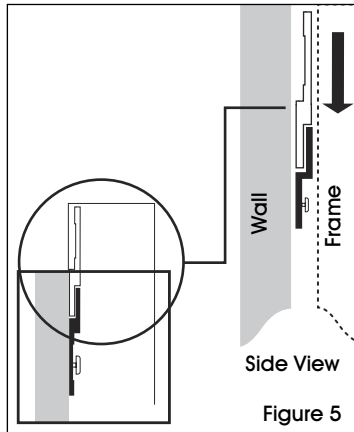

Figure 4

5. Lower board onto the top hanging brackets so built-in brackets on upper board frame are engaged. (See Figure 5)



Side View

Figure 5

BOTTOM L-BRACKET MOUNTING

1. With board hanging on top brackets, align L-brackets with pre-drilled holes (located on bottom of frame) and mark position. (See Figure 6)

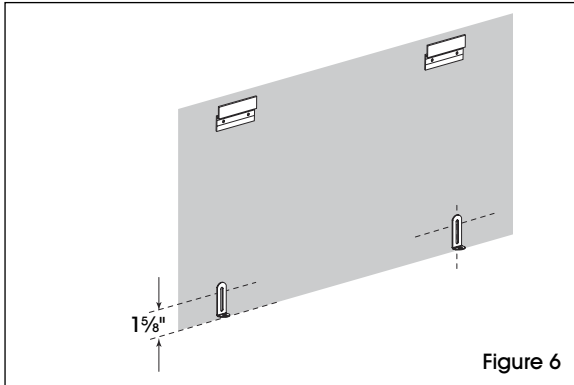

2. Remove board and mark wall $1\frac{5}{8}$ " from bottom of L-brackets. (See Figure 7)

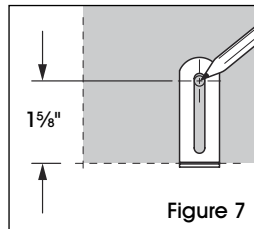

3. Drill holes in marked locations using $\frac{1}{4}$ " drill bit. Insert wall anchors into holes flush with wall.
4. Insert $1\frac{1}{4}$ " screws through L-brackets into wall anchors. Do not overtighten. (See Figure 8)
5. Hang board and insert $\frac{1}{4}$ " screw and washer through each L-bracket and into pre-drilled hole in frame. Tighten firmly. (See Figure 9)

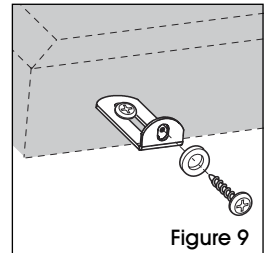
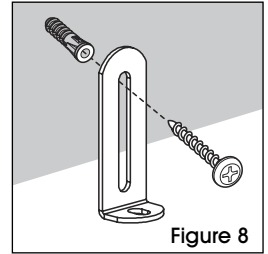

ULINE

1-800-295-5510
uline.com

ULINE H-3040, H-3041

PIZARRÓN CERRADO DE CORCHO

800-295-5510
uline.mx

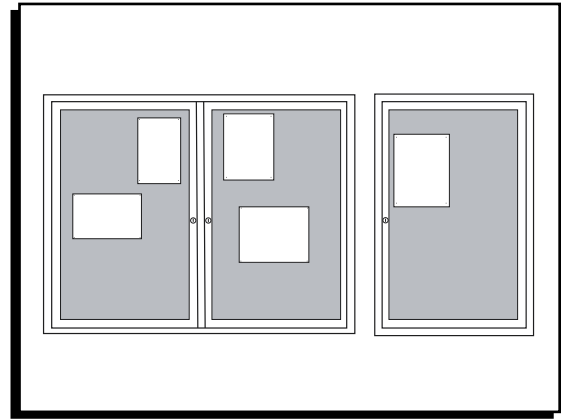

HERRAMIENTAS NECESARIAS



Taladro

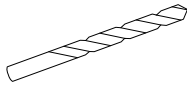

Broca de 1/4"

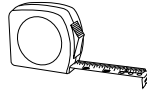

Cinta de Medir

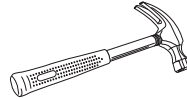

Martillo

PARTES

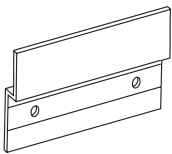

2 Soportes para Colgar

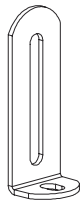

2 Soportes en "L"



6 Taquetes para Panel de Yeso

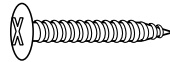

6 Tornillos de 1/4"

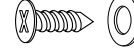

2 Tornillos de 1/4" y Rondanas

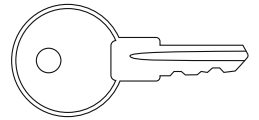

2 Llaves

MONTAJE DE LOS SOPORTES PARA COLGAR SUPERIORES

- Determine la posición del pizarrón. Coloque los soportes superiores para colgar a 15 cm (6") del borde externo del pizarrón con los orificios de los soportes a 7 cm (2 3/4") de la parte superior del pizarrón. (Vea Diagrama 1)

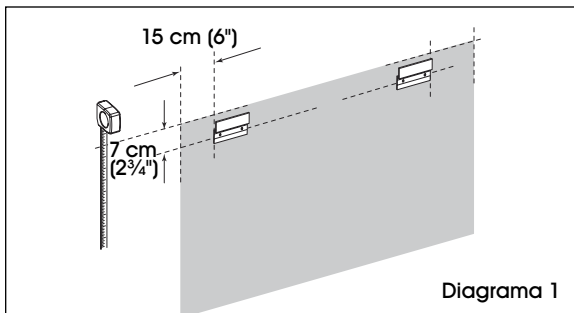

- Marque la pared en los centros de los orificios de los soportes. (Vea Diagrama 2)
- Perfore orificios para cada soporte en las ubicaciones marcadas utilizando una broca de 1/4". (Vea Diagrama 3)

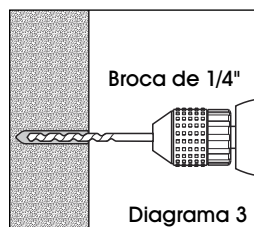
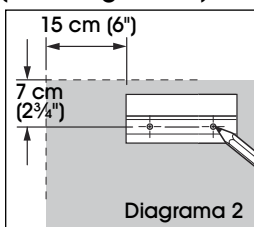

- Inserte los taquetes en los orificios, a ras de la pared. Inserte los tornillos de 1/4" en los taquetes a través de los soportes para colgar. Apriete firmemente. (Vea Diagrama 4)

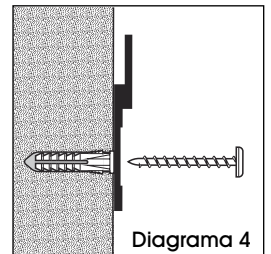

- Baje el pizarrón sobre los soportes superiores para colgar de modo que los soportes integrados del borde superior del marco del pizarrón se enganchen. (Vea Diagrama 5)

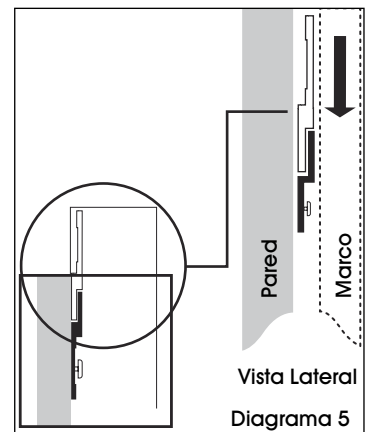

MONTAJE DE LOS SOPORTES INFERIORES EN "L"

1. Con el pizarrón colgando de los soportes superiores, alinee los soportes en "L" con los orificios perforados previamente (ubicados en la parte inferior del marco) y marque la posición. (Vea Diagrama 6)

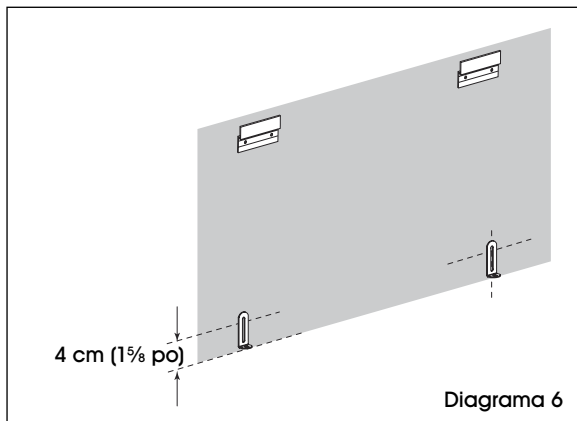

2. Retire el tablero y marque la pared a 4 cm (1 5/8") de la parte inferior de los soportes en "L". (Vea Diagrama 7)

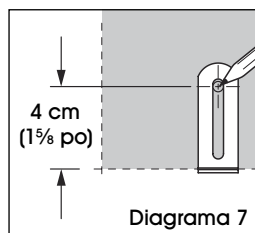

3. Perfore con una broca de 1/4" los orificios en los lugares marcados. Inserte los taquetes para pared en los orificios y verifique que queden a ras con la pared.
4. Inserte los tornillos de 1 1/4" a través de los soportes en "L" y en los taquetes. No los apriete demasiado. (Vea Diagrama 8)
5. Cuelgue el tablero e inserte un tornillo de 1/4" con rondana a través de cada soporte en "L" y en cada orificio preperforado en el marco. Apriete firmemente. (Vea Diagrama 9)

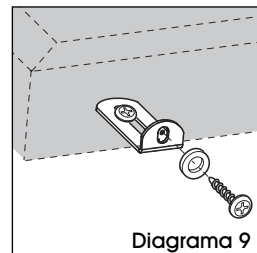
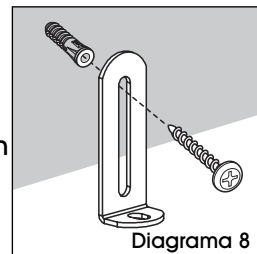

ULINE

800-295-5510
uline.mx

ULINE H-3040, H-3041

TABLEAU DE LIÈGE AVEC PORTE

1 800 295-5510
uline.ca

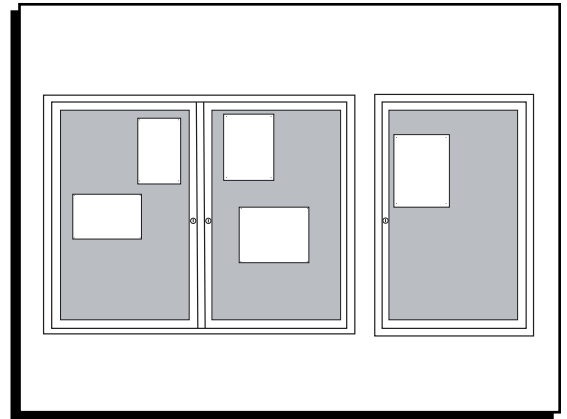

OUTILS REQUIS



Perceuse

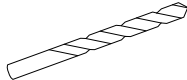

Foret de 1/4 po

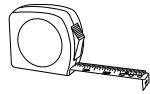

Ruban à mesurer

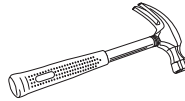

Marteau

PIÈCES

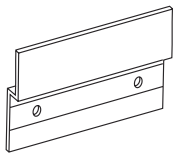

Support de suspension x 2

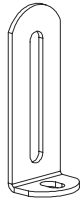

Support en L x 2



Cheville d'ancrage pour cloisons sèches x 6

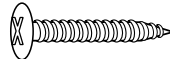

Vis de 1 1/4 po x 6



Vis de 1/4 po et rondelle x 2

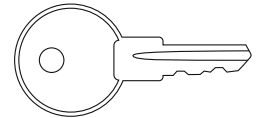

Clé x 2

INSTALLATION DES SUPPORTS DE SUSPENSION SUPÉRIEURS

- Déterminez l'emplacement du tableau. Placez les supports de suspension à 15 cm (6 po) de la bordure extérieure du tableau, et les trous des supports à 7 cm (2 3/4 po) du haut du tableau. (Voir Figure 1)

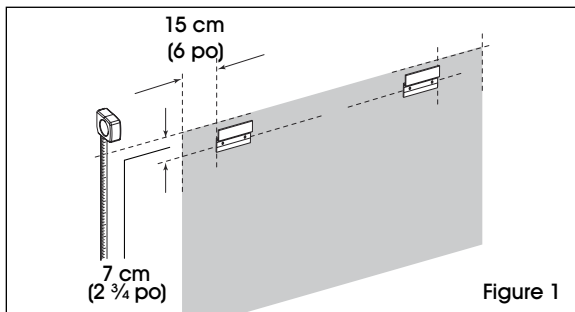

Figure 1

- Marquez des points de repère au mur au centre des trous des supports. (Voir Figure 2)
- Percez des trous pour chaque support aux emplacements marqués avec le foret de 1/4 po. (Voir Figure 3)

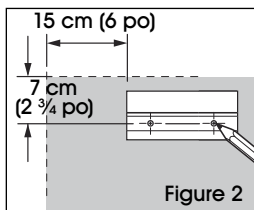

Figure 2

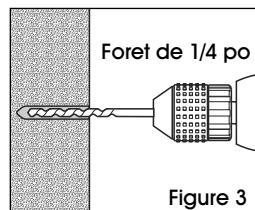

Figure 3

- Insérez les chevilles d'ancrage dans les trous jusqu'à ce qu'elles soient au ras du mur. Insérez ensuite les vis de 1 1/4 po dans les chevilles d'ancrage, au travers des supports de suspension. Vissez fermement. (Voir Figure 4)

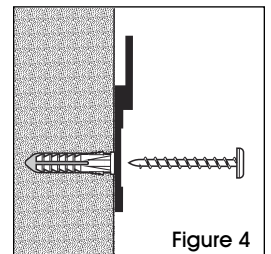
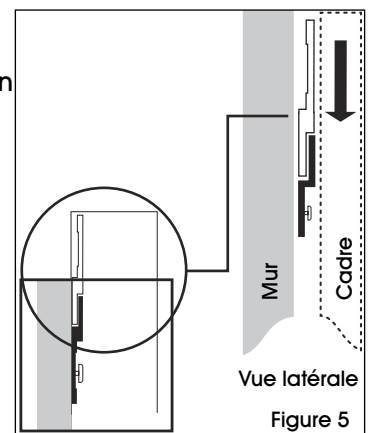

Figure 4

- Abaissez le tableau sur le dessus des supports de suspension de façon à ce que les supports intégrés dans le cadre supérieur du tableau s'engagent. (Voir Figure 5)



Vue latérale

Figure 5

INSTALLATION DES SUPPORTS EN L INFÉRIEURS

1. Avec le tableau suspendu par les supports du haut, alignez les supports en L sur les trous prépercés (situés au bas du cadre) et marquez la position. (Voir Figure 6)

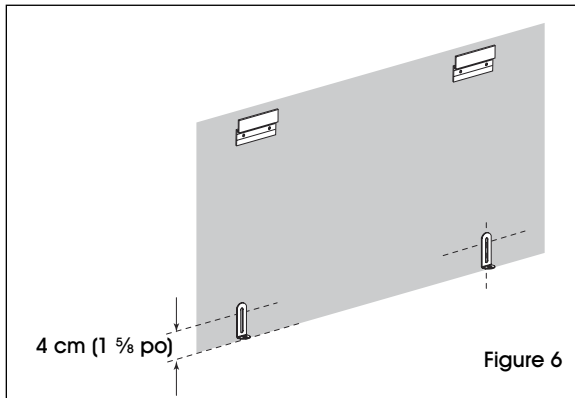

2. Retirez le tableau et marquez le mur à 4 cm (1 5/8 po) du bas des supports en L. (Voir Figure 7)

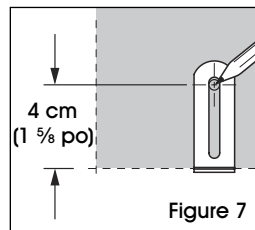

3. Percez des trous aux endroits marqués à l'aide d'un foret de 1/4 po. Insérez les chevilles d'ancrage dans les trous jusqu'à ce qu'elles soient au ras du mur.
4. Insérez les vis de 1 1/4 po dans les chevilles d'ancrage, au travers des supports en L. Vissez sans trop serrer. (Voir Figure 8)
5. Suspendez le tableau et insérez une vis de 1/4 po et une rondelle dans les trous prépercés dans le cadre, au travers des supports en L. Vissez fermement. (Voir Figure 9)

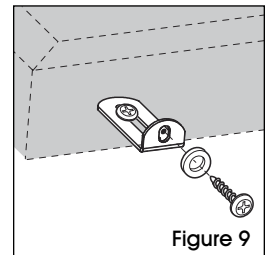
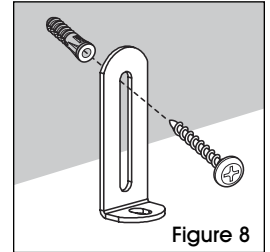

ULINE

1 800 295-5510
uline.ca