

ULINE H-3575, H-3576
H-3577, H-3578
PLASTIC DUNNAGE RACKS

1-800-295-5510
uline.com

ASSEMBLY INSTRUCTIONS

Step 1 – Lay panel face down and insert 12" posts as shown.
(Make sure posts are pushed all the way down.)

Step 2 – Return rack to upright position.

 **NOTE:** Oil all sockets before assembly.

COMPONENTS
H-3575



36 x 24" Panel x 1
12" Post x 5

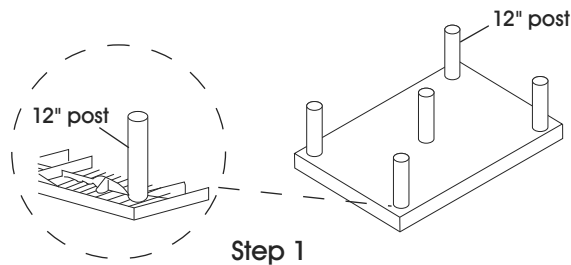

Step 1

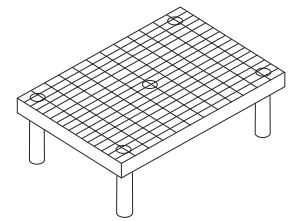

Step 2

COMPONENTS
H-3576

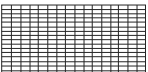

48 x 24" Panel x 1
12" Post x 9

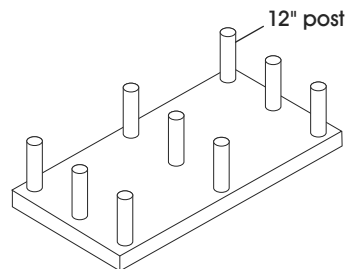

Step 1

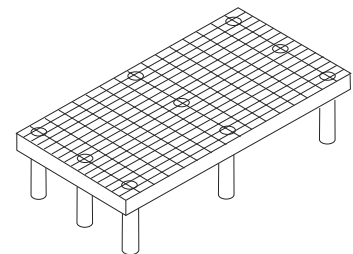

Step 2

COMPONENTS
H-3577

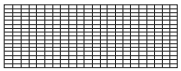

66 x 24" Panel x 1
12" Post x 8

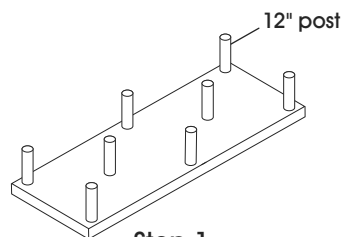

Step 1

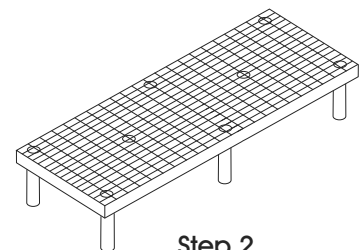

Step 2

COMPONENTS
H-3578

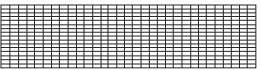

96 x 24" Panel x 1
12" Post x 11

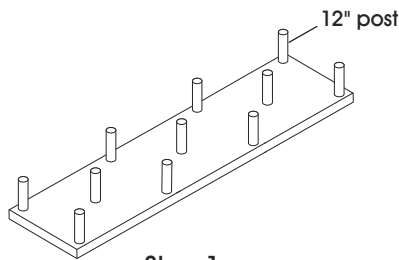

Step 1

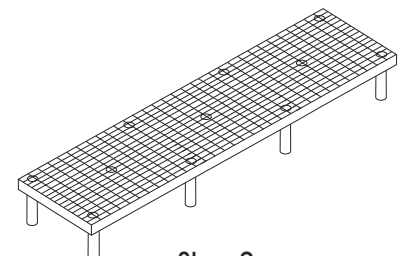

Step 2

INSTRUCCIONES DE ENSAMBLE

Paso 1 – Coloque el panel boca abajo e inserte los postes de 30.5 cm (12") como se muestra. (Asegúrese de que los postes están insertados hasta el fondo).

Paso 2 – Vuelva a colocar el rack en posición vertical.

 **NOTA:** Lubrique todas las ranuras antes del ensamble.

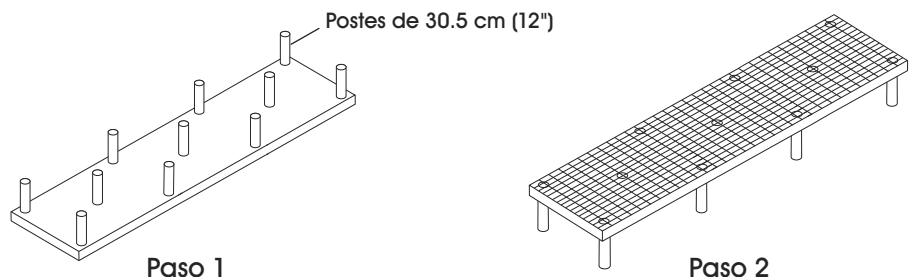
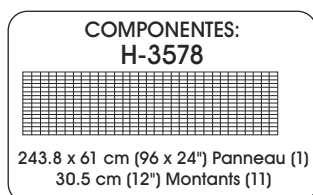
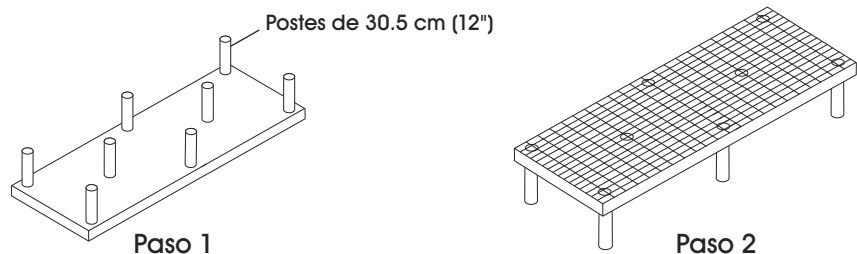
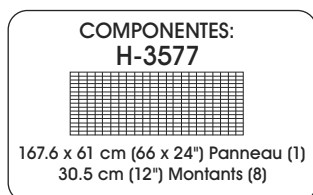
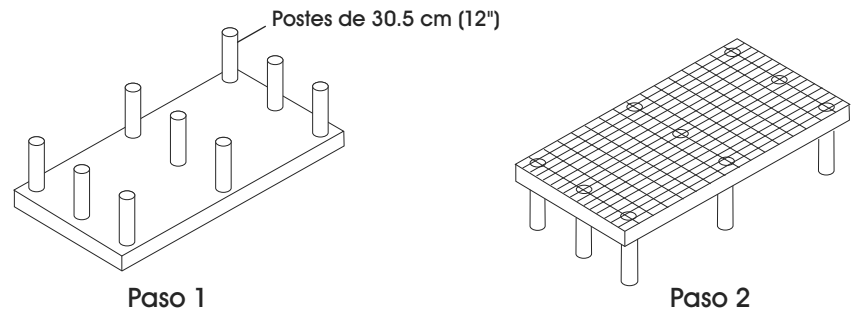
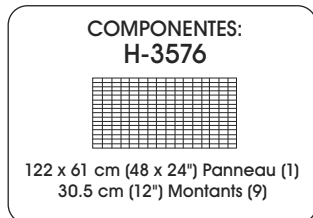
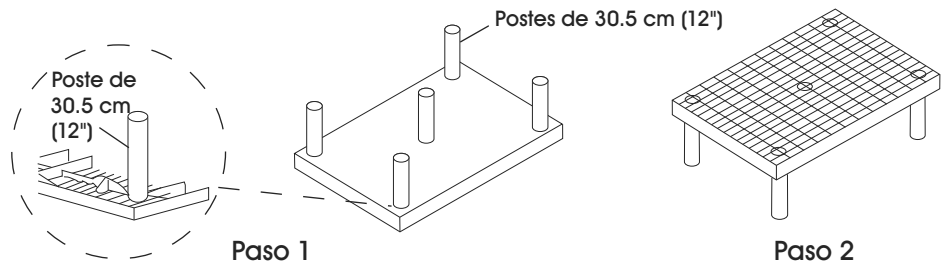
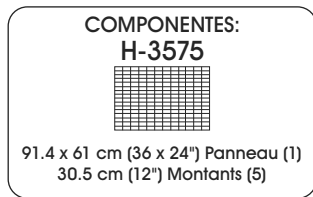

**SUPPORTS DE FARDAGE
EN PLASTIQUE****INSTRUCTIONS D'ASSEMBLAGE**

Étape 1 – Déposez le panneau face contre terre et insérez les montants de 30,5 cm (12 po) comme indiqué. (Assurez-vous que les montants sont complètement enfoncés.)

Étape 2 – Retournez le support en position debout.

 **REMARQUE :** Huilez toutes les emboîtures avant l'assemblage.

