

ULINE H-4283, H-4284 HEADLESS MANNEQUIN

1-800-295-5510
uline.com

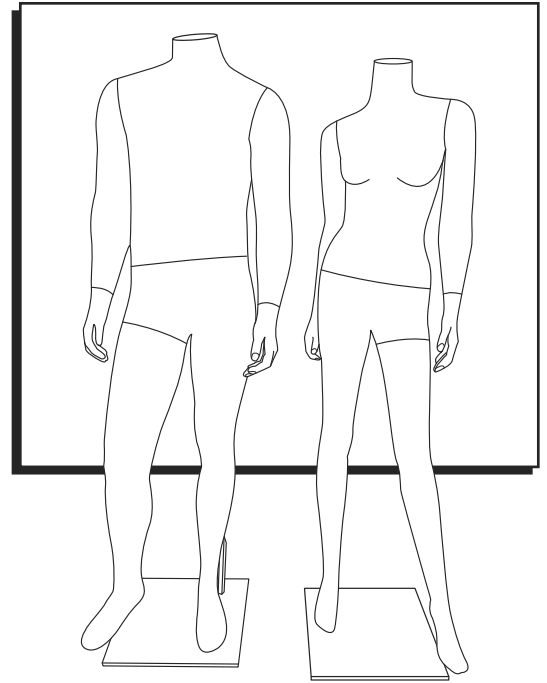

PARTS

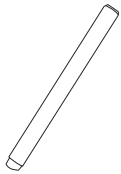

Foot Attachment



Screw



Washer

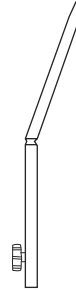

Calf Attachment

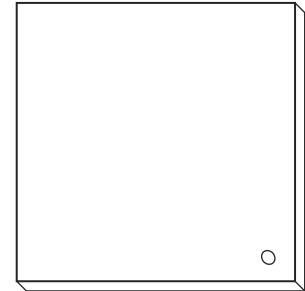

Glass Base



Left Hand



Right Hand



Right Arm



Left Arm



Leg

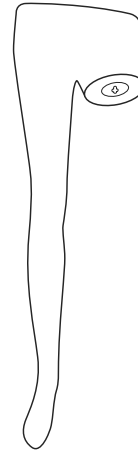

Leg/Hip Assembly

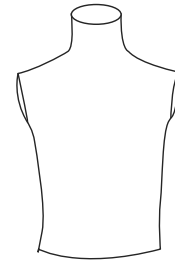

Torso



Torso Attachment

ASSEMBLY

1. Attach foot attachment to glass base using screw and washer. (See Figure 1)

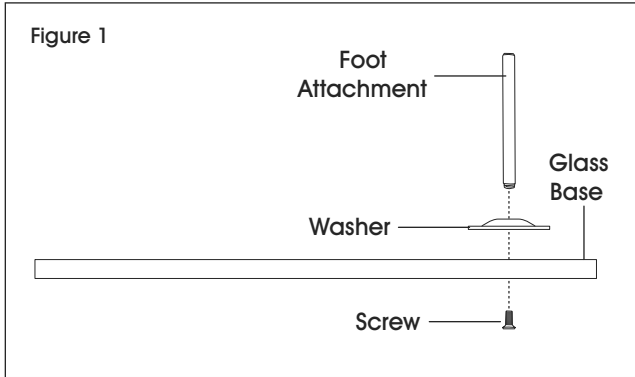

CAUTION! Glass base can be easily broken. Use care during assembly.

2. For calf attachment assembly, slide calf attachment over foot attachment. Tighten set screw. (See Figure 2)

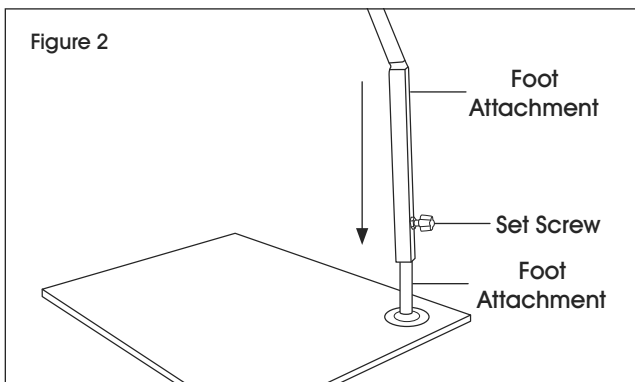

NOTE: Calf attachment allows shoes to be displayed on mannequin.

3. Attach leg to leg/hip assembly by matching the pin on the leg to the hole in the leg/hip assembly. (See Figure 3)

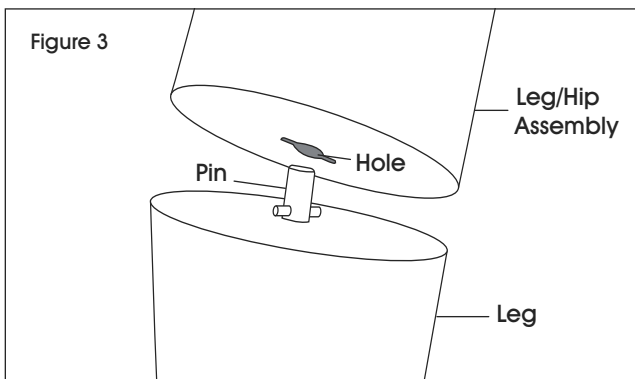

4. Twist until the leg is aligned with the leg/hip assembly.

5. Insert foot attachment into hole in the heel of the foot. If using calf attachment, insert calf attachment into the hole in the calf. (See Figure 4)

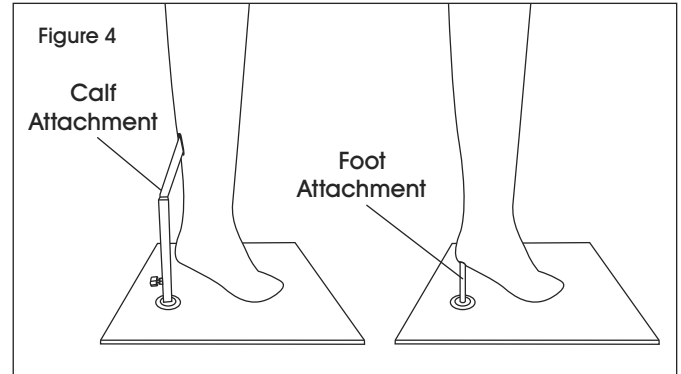

NOTE: The calf and foot attachment should be inserted into the left foot of the male mannequin and into the right foot of the female mannequin.

6. Attach torso attachment to leg/hip assembly by turning clockwise. (See Figure 5)
7. Attach torso to leg/hip assembly by placing torso on top of torso attachment and twisting torso into place. (See Figure 5)

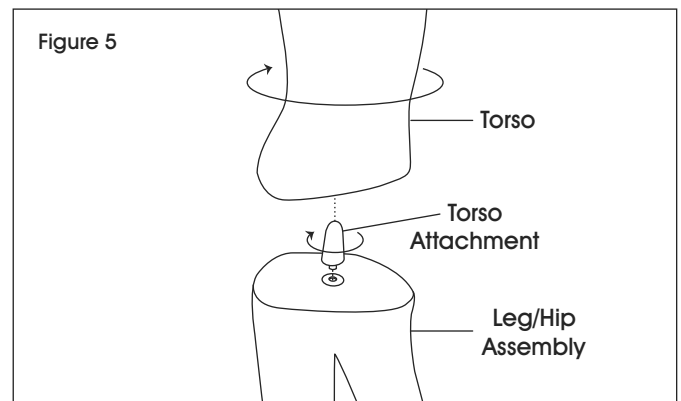

NOTE: Make sure glass base is held in place while twisting torso.

ASSEMBLY CONTINUED

8. Attach right arm to torso by inserting arm pin into hole in torso. (See Figure 6)

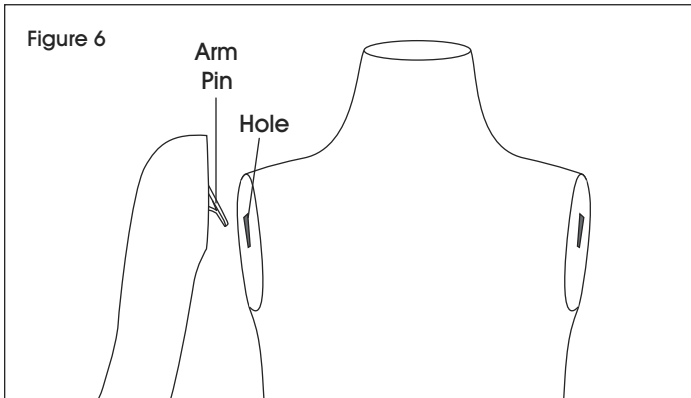

9. Repeat for left arm.
10. Attach right hand to right arm and screw into place. (See Figure 7)

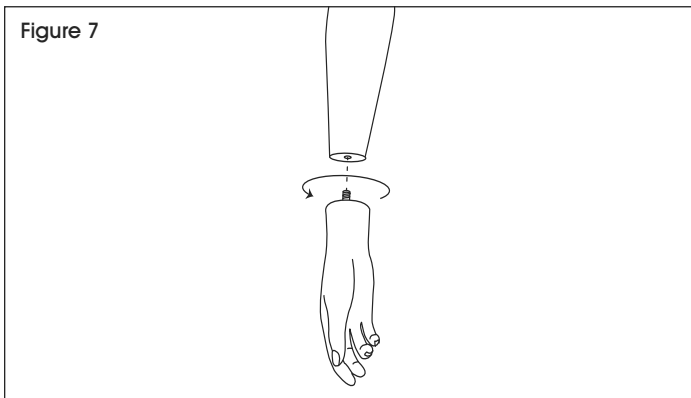

11. Repeat for left hand.

ULINE

1-800-295-5510
uline.com

ULINE H-4283, H-4284
MANIQUÍ SIN CABEZA

800-295-5510
uline.mx

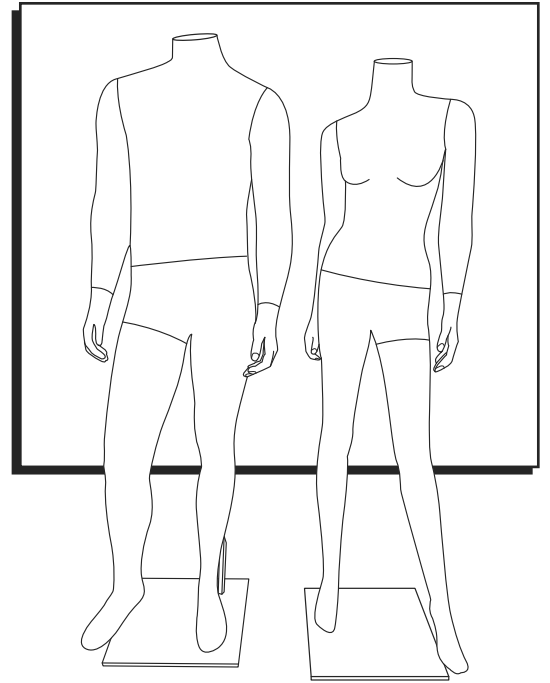

PARTES

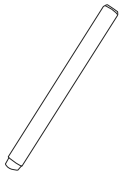

Aditamento del Pie



Tornillo



Rondana

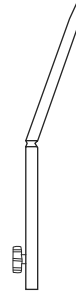

Aditamento de la Pantorrilla

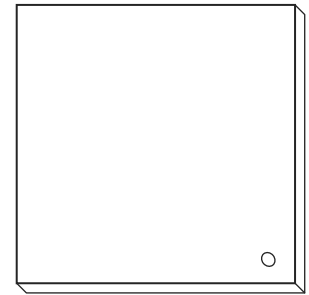

Base de Vidrio



Mano Izquierda



Mano Derecha



Brazo Derecho



Brazo Izquierdo



Pierna

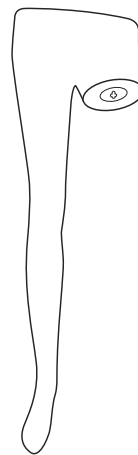

Ensamble de Pierna/Cadera

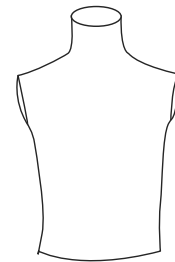

Torso



Aditamento del Torso

ENSAMBLE

1. Fije el aditamento del pie a la base de vidrio utilizando un tornillo y rondana. (Vea Diagrama 1)



¡PRECAUCIÓN! La base de vidrio puede quebrarse fácilmente. Sea cuidadoso durante el ensamble.

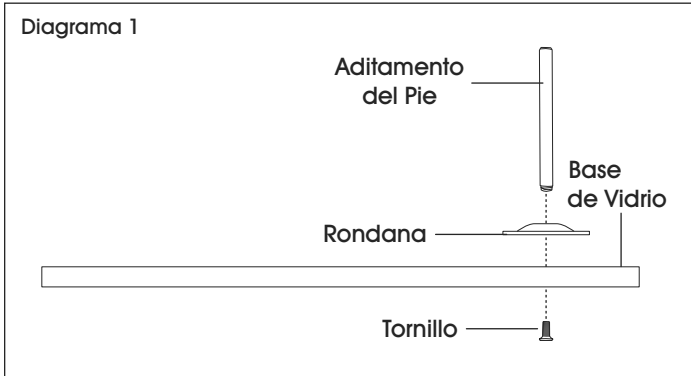

2. Para ensamblar el aditamento de la pantorrilla, deslice el aditamento de la pantorrilla sobre el aditamento del pie. Apriete el tornillo de ajuste. (Vea Diagrama 2)



NOTA: El aditamento de la pantorrilla permite exhibir zapatos en el maniquí.

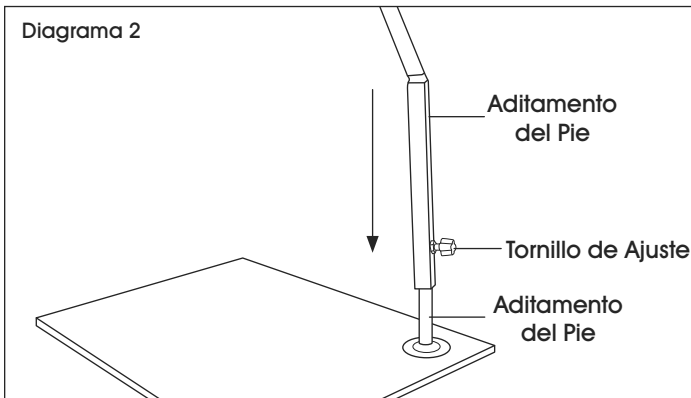

3. Fije la pierna al ensamble de la pierna/cadera haciendo coincidir el perno de la pierna en el orificio del ensamble de la pierna/cadera. (Vea Diagrama 3)

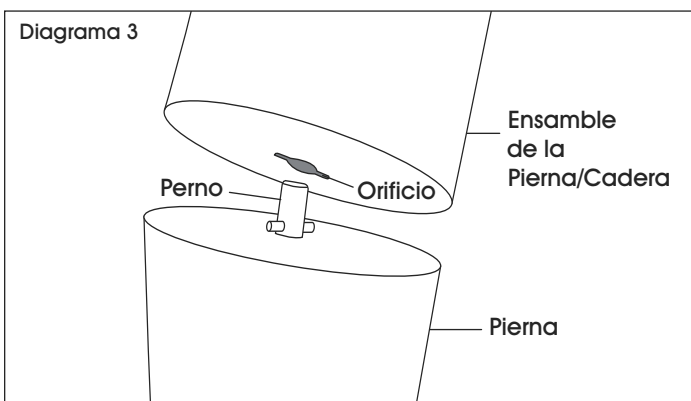

4. Gire hasta que la pierna esté alineada con el ensamble de la pierna/cadera.
5. Inserte el aditamento del pie dentro del orificio del talón del pie. Si va a utilizar el aditamento de la pantorrilla, inserte el aditamento de la pantorrilla dentro del orificio en la pantorrilla. (Vea Diagrama 4)

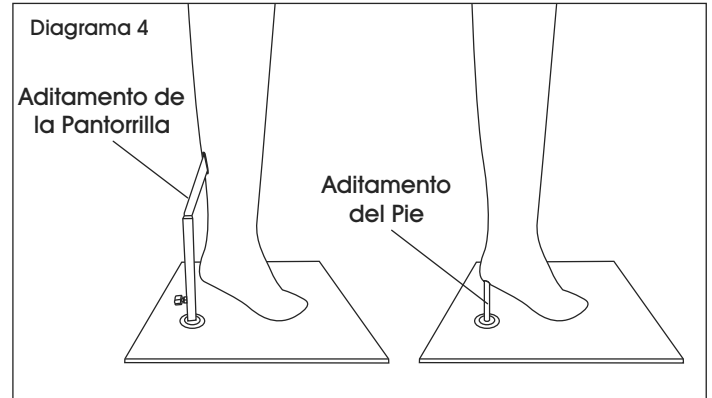

NOTA: Los aditamentos de la pantorrilla y pie deben ser insertados dentro del pie izquierdo del maniquí masculino y dentro del pie derecho del maniquí femenino.

6. Repita el procedimiento con la mano izquierda.
7. Fije el aditamento del torso al ensamble de la pierna/cadera girando en el sentido de las manecillas del reloj. (Vea Diagrama 5)
8. Fije el torso al ensamble de la pierna/cadera colocando el torso sobre la parte superior del aditamento del torso y girando el torso en su lugar. (Vea Diagrama 5)

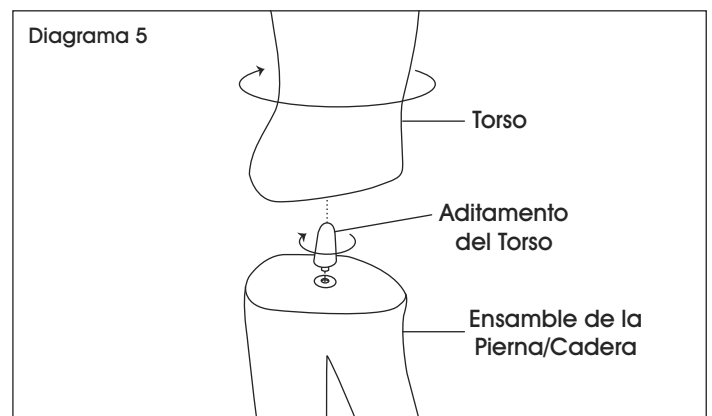

NOTA: Asegúrese que la base de vidrio permanece en su lugar mientras gira el torso.

CONTINUACIÓN DE ENSAMBLE

9. Fije el brazo derecho al torso insertando el perno del brazo dentro del orificio en el torso.
(Vea Diagrama 6)

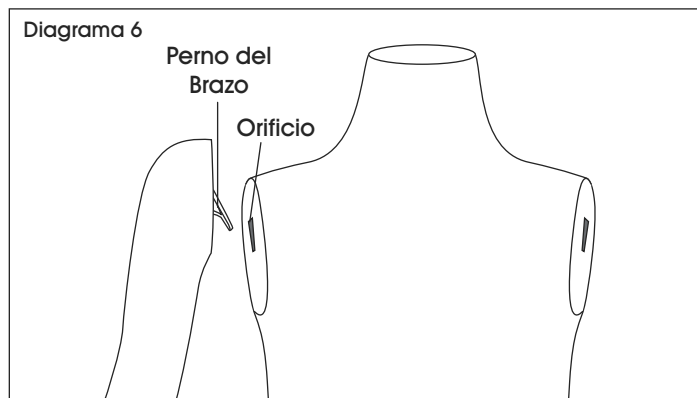

10. Repita con el brazo izquierdo.
11. Fije la mano derecha al brazo derecho y atornille en su lugar. (Vea Diagrama 7)

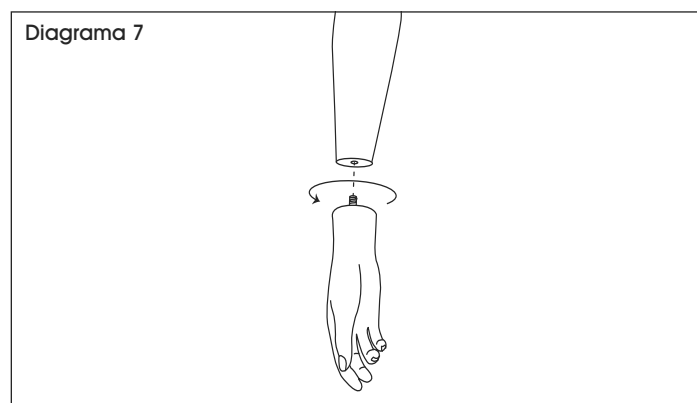

12. Repita el procedimiento con la mano izquierda.

ULINE

800-295-5510
uline.mx

ULINE H-4283, H-4284
MANNEQUIN SANS TÊTE

1-800-295-5510
uline.ca

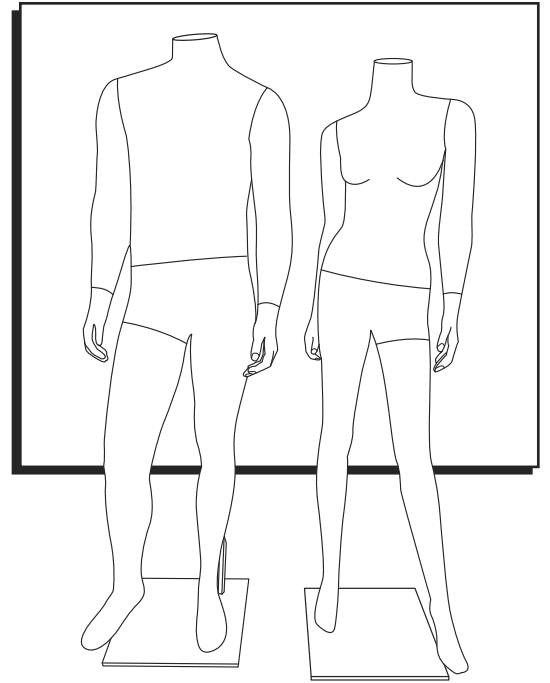

PIÈCES

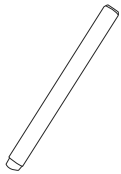

Attachement
de pied



Vis



Rondelle

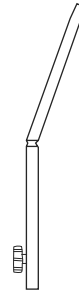

Attachement
de mollet

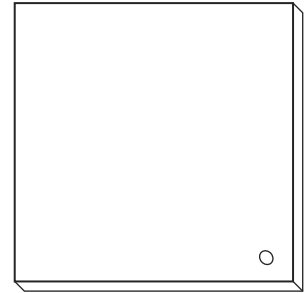

Base de verre



Main
gauche



Main droite



Bras droit



Bras
gauche



Jambe

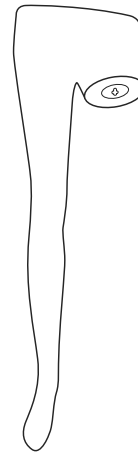

Ensemble jambe/
hanche

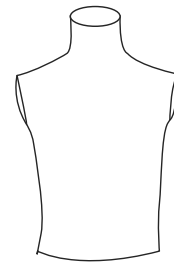

Tronc



Attachement
de torse

ASSEMBLAGE

1. Fixez l'attachement de pied sur la base de verre à l'aide de la vis et de la rondelle. (Voir Figure 1)



MISE EN GARDE! La base de verre est facile à briser. Effectuez l'assemblage avec soin.

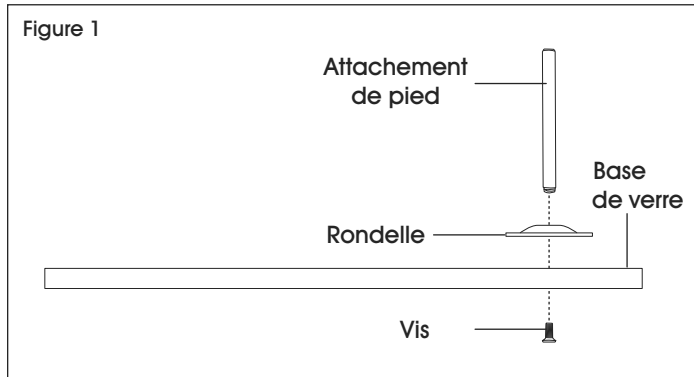

2. Pour l'assemblage de l'attachement de mollet, glissez l'attachement de mollet sur l'attachement de pied. Serrez la vis de réglage. (Voir Figure 2)

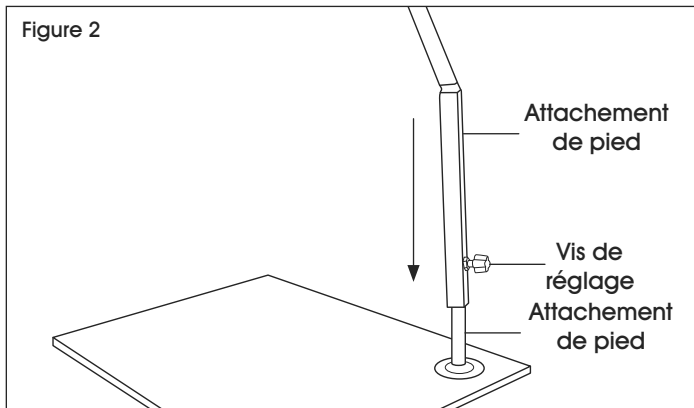

REMARQUE : L'attachement de mollet permet l'exposition de chaussures sur le mannequin.

3. Fixez l'ensemble jambe/hanche en insérant la tige de la jambe dans le trou de l'ensemble jambe/hanche. (Voir Figure 3)

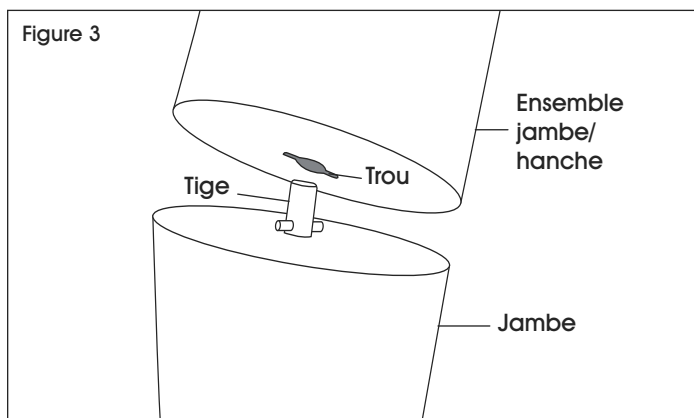

4. Tournez la jambe jusqu'à ce qu'elle s'aligne avec l'ensemble jambe/hanche.
5. Insérez l'attachement de pied dans le trou sous le talon du pied. Si vous employez l'attachement de mollet, insérez l'attachement de mollet dans le trou du mollet. (Voir Figure 4)

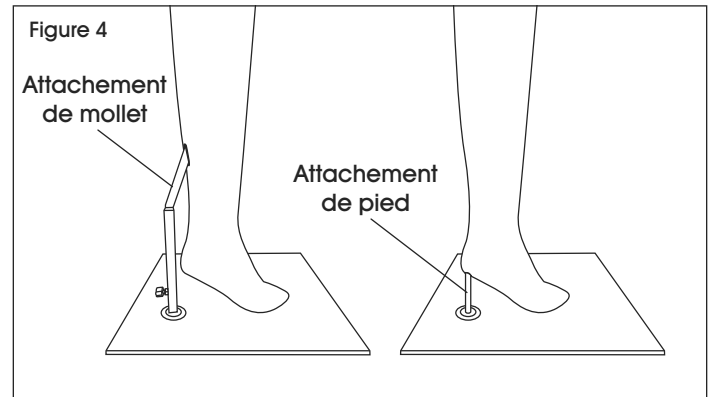

REMARQUE : Les attachements de pied et de mollet doivent être insérés dans le pied ou le mollet gauche du mannequin masculin et dans le pied ou le mollet droit du mannequin féminin.

6. Fixez l'attachement de tronc à l'ensemble jambe/hanche en tournant dans le sens horaire. (Voir Figure 5)
7. Fixez le tronc à l'ensemble jambe/hanche en déposant le tronc sur l'attachement de tronc et en le tournant à la position appropriée. (Voir Figure 5)

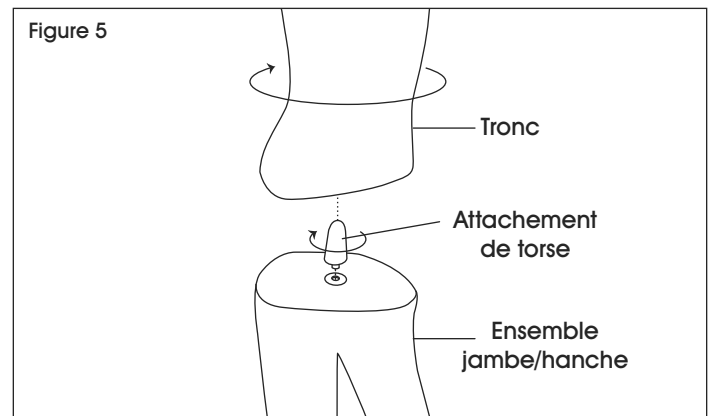

REMARQUE : Assurez-vous que la base de verre est arrimée pendant que vous tournez le tronc.

ASSEMBLAGE SUITE

- Fixez le bras droit sur le tronc en insérant la tige du bras dans le trou approprié du tronc. (Voir Figure 6)

Figure 6

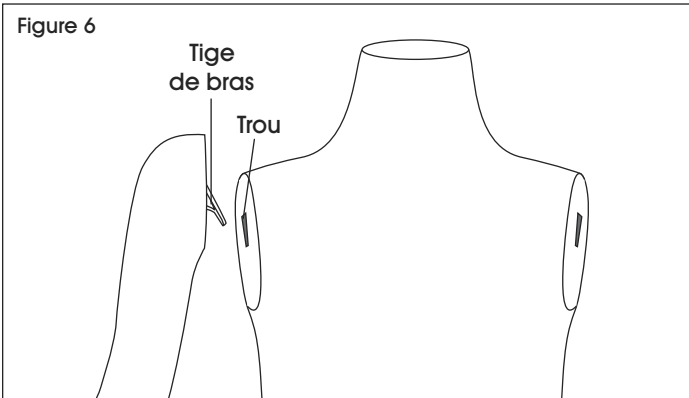

- Répétez la même procédure pour le bras gauche.
- Vissez la main droite au bras droit. (Voir Figure 7)

Figure 7

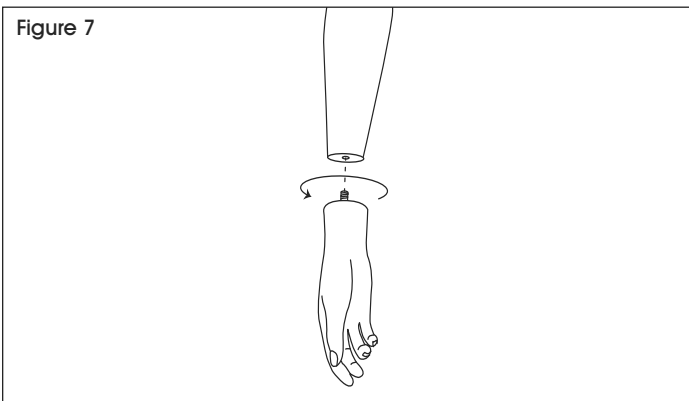

- Répétez la même procédure pour la main gauche.

ULINE

1-800-295-5510
uline.ca