

# ULINE H-4755 TIP AND ROLL KIT FOR 3-ROW BLEACHERS

1-800-295-5510  
uline.com

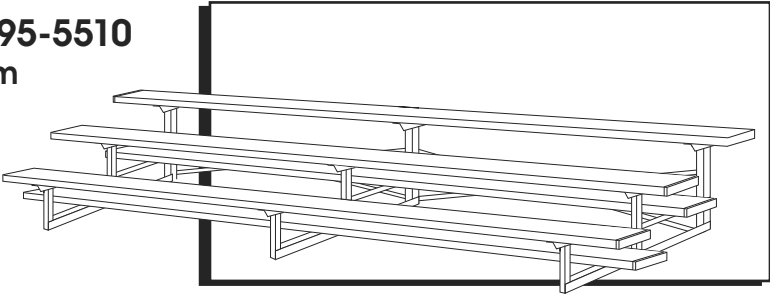

**WARNING!** Due to outdoor wind hazards, bleachers with tip and roll kits, while suitable for indoor or outdoor use, should only be tipped up onto the casters when indoors in order to prevent them from tipping back over unintentionally.

## TOOLS NEEDED



Drill



Flathead Drill Bit

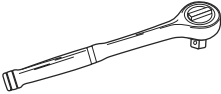

Socket Wrench



1/2" Deep Well Socket



9/16" Deep Well Socket

## PARTS



Screw x 12



Washer x 12



5/16" Flange Nut x 12



3/8" Flange Nut x 4

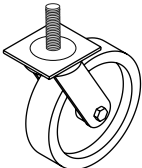

5" Swivel Caster x 2

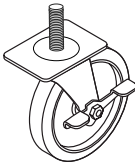

5" Swivel Caster with Brake x 2

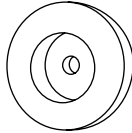

Rubber Foot Pad x 12

# ASSEMBLY

1. Each of the three bleacher frames has four pre-drilled holes along the bottom. (See Figure 1)

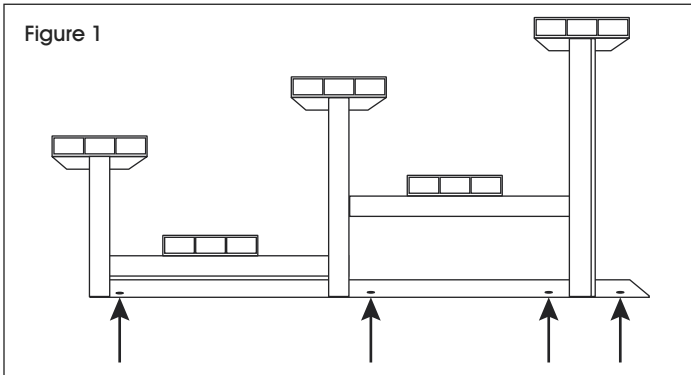

2. Attach four rubber foot pads to the pre-drilled holes using a screw, washer and 5/16" flange nut. (See Figure 2)

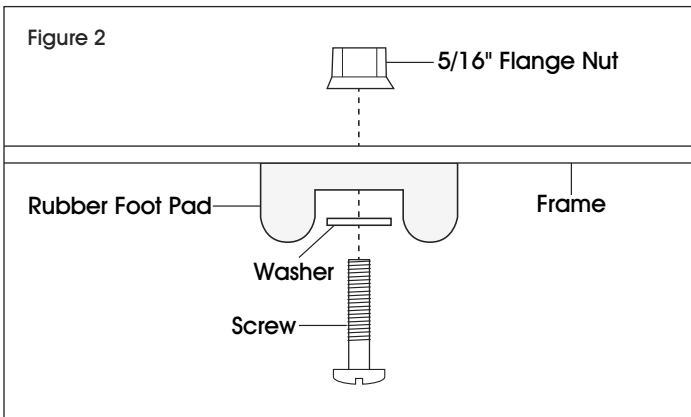

3. Each of the three bleacher frames has four pre-drilled holes along the back. Insert casters into top and second pre-drilled hole from bottom. (See Figure 3)

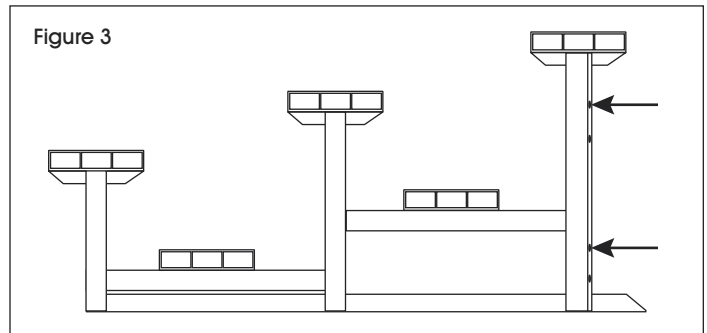

4. Secure casters into the pre-drilled holes using 3/8" flange nuts. (See Figure 4)

 **NOTE:** Casters with brakes go on second pre-drilled hole from bottom.

 **NOTE:** Casters go on outside frames only. There are no casters on middle frame.

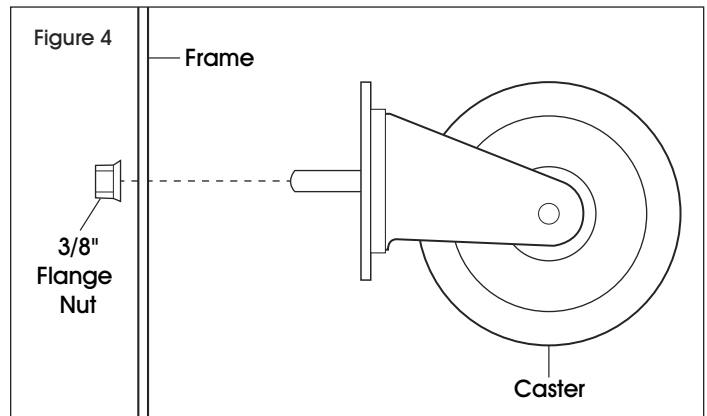

**ULINE**

1-800-295-5510  
uline.com

**ULINE H-4755**

# KIT DE RUEDAS PARA INCLINAR Y DESLIZAR GRADAS DE 3 FILAS

800-295-5510  
uline.mx

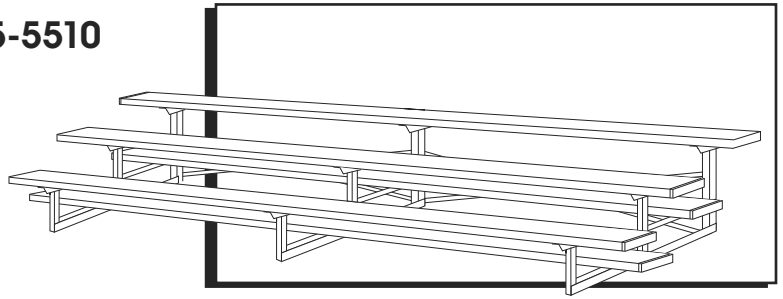

**ALTO**

**¡ADVERTENCIA!** Debido al peligro de los vientos al aire libre, las gradas con kit de ruedas para inclinar y deslizar, cuando sea adecuado su uso en interiores o exteriores, solo deben estar inclinadas hacia arriba cuando esté en interiores para evitar que se vuelque hacia atrás accidentalmente.

## HERRAMIENTAS NECESARIAS



Taladro



Broca de Cabeza Plana

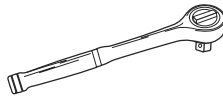

Matraca



Dado Largo de 1/2"



Dado Largo de 9/16"

## PARTES



12 Tornillos



12 Rondanas



12 Tuercas con Reborde de 5/16"



4 Tuercas con Reborde de 3/8"

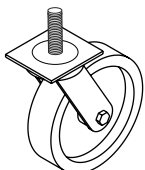

2 Ruedas Giratorias de 5"

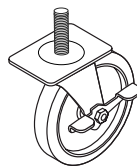

2 Ruedas Giratorias con Freno de 5"

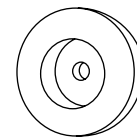

12 Empaques de Caucho para Patas

# ENSAMBLE

1. Cada uno de los tres armazones de las gradas tiene cuatro orificios pretaladrados en la parte inferior. (Vea Diagrama 1)

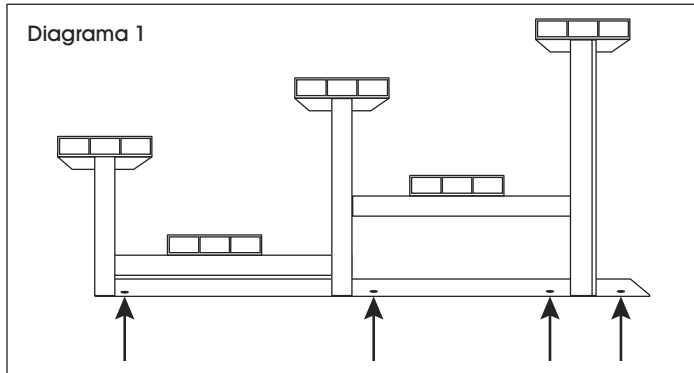

2. Fije cuatro empaques de caucho para patas a los orificios pretaladrados usando un tornillo, una rondana y una tuerca con reborde de 5/16". (Vea Diagrama 2)

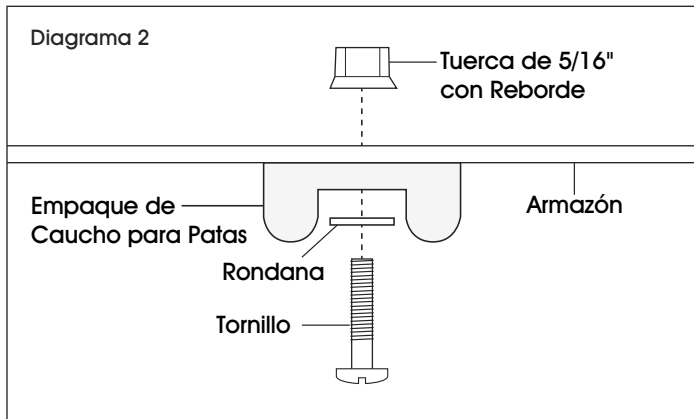

3. Cada uno de los tres armazones de las gradas tiene dos orificios pretaladrados en la parte posterior. (Vea Diagrama 3)

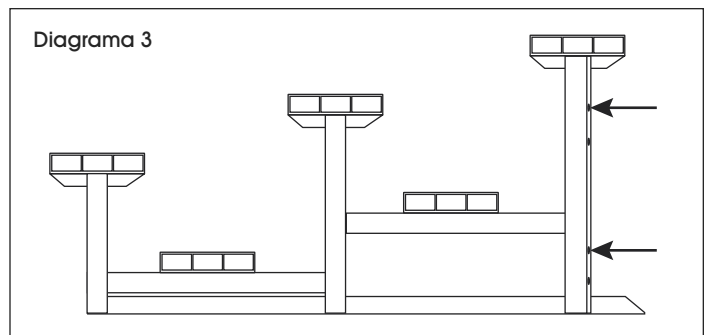

4. Inserte las ruedas en los orificios pretaladrados y fíjelas usando tuercas con reborde de 3/8". (Vea Diagrama 4)

 **NOTA:** Las ruedas con freno van en los orificios inferiores.

 **NOTA:** Las ruedas se colocan únicamente en el exterior de los marcos. No hay ruedas en el marco central.

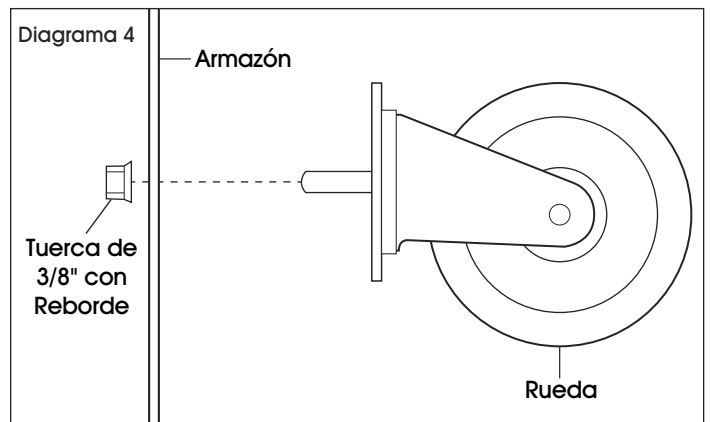

**ULINE**

800-295-5510  
uline.mx

**ULINE H-4755**

# ENSEMBLE DE ROULETTES BASCULE ET ROULE POUR GRADINS À 3 RANGÉES

1-800-295-5510  
uline.ca

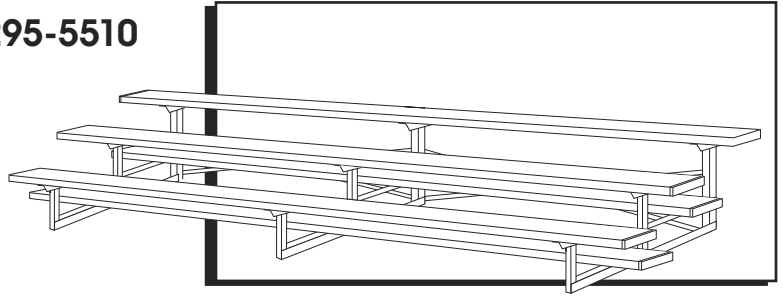

**AVERTISSEMENT!** En raison des risques de vents extérieurs, les gradins avec ensembles de roulettes bascule et roule, bien qu'ils conviennent aux environnements intérieurs et extérieurs, ne doivent avoir les roulettes inclinées vers le haut que si les gradins sont disposés à l'intérieur, et ce, afin d'empêcher qu'ils ne basculent accidentellement vers l'arrière.

## OUTILS REQUIS



Perceuse

mèche plate

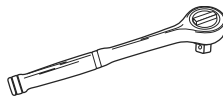

Clé à douilles



Clé à douilles



Douille profonde de 9/16 po

## PIÈCES



Vis x 12



Rondelle x 12



Écrou à embase de 5/16 po x 12



Écrou à embase de 3/8 po x 4

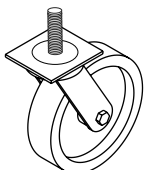

Roulette pivotante de 5 po x 2

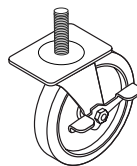

Roulette pivotante avec frein de 5 po x 2

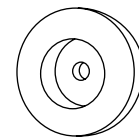

Tampon en caoutchouc x 12

# ASSEMBLAGE

1. Chacune des trois structures de gradins comporte quatre trous prépercés le long de la partie inférieure. (Voir Figure 1)

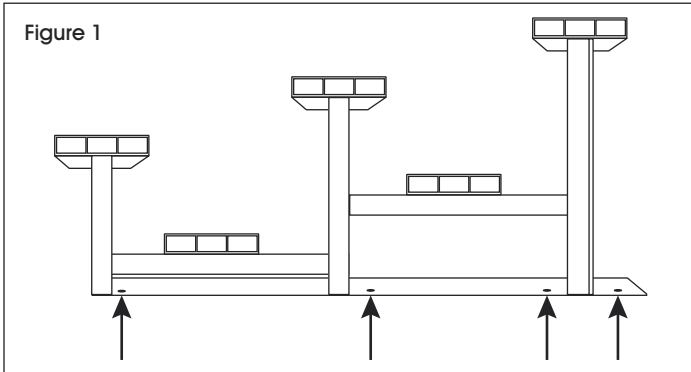

2. Fixez les quatre tampons en caoutchouc dans les trous prépercés à l'aide d'une vis, d'une rondelle et d'un écrou à embase de 5/16 po. (Voir Figure 2)

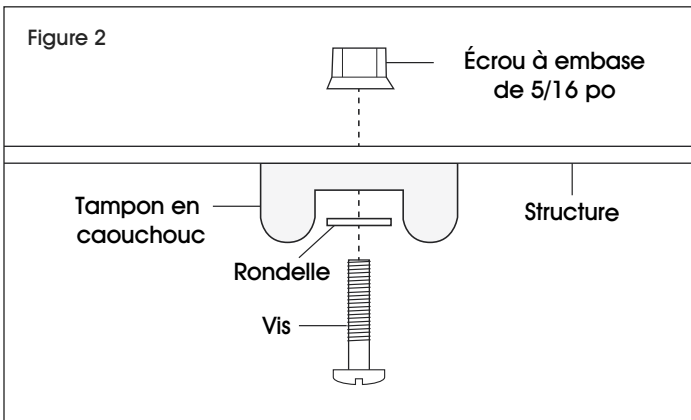

3. Chacune des trois structures de gradins comporte deux trous prépercés le long de la partie arrière. (Voir Figure 3)

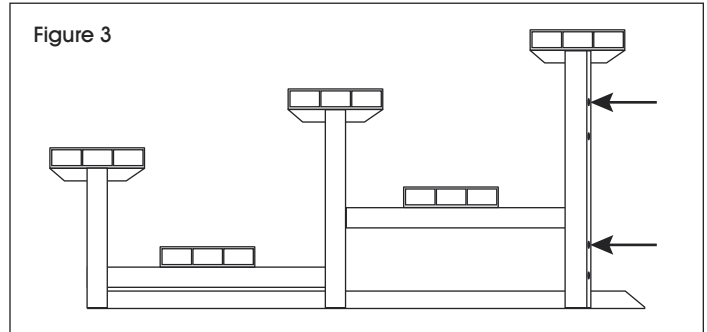

4. Insérez les roulettes dans les trous prépercés et fixez-les à l'aide d'écrous à embase de 3/8 po. (Voir Figure 4)

 **REMARQUE :** Les roulettes avec freins vont dans les trous inférieurs.

 **REMARQUE :** Les roulettes se raccordent uniquement aux structures extérieures. Aucune roulette ne se raccorde à la structure du milieu.

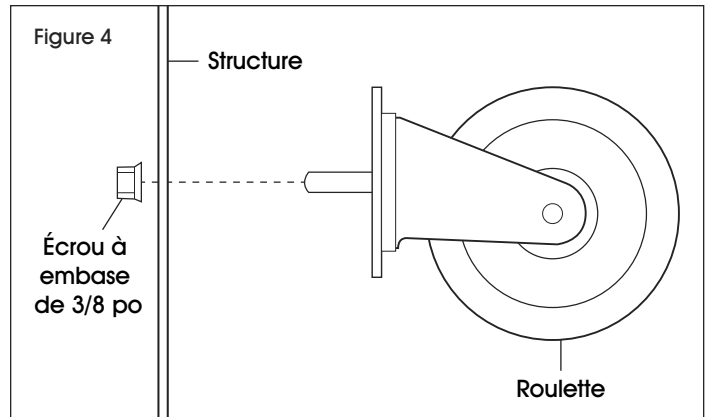

**ULINE**

1-800-295-5510  
uline.ca