

ULINE H-5175 RUBBER CORNER GUARD

1-800-295-5510
uline.com

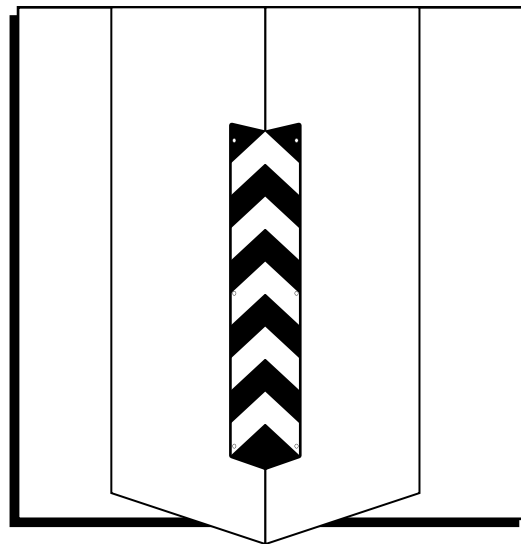

INSTALLATION

 **NOTE: Hardware not included.**

1. Place the corner guard at the desired position.
(See Figure 1)
2. Mark the screw hole positions (6) on the wall.
(See Figure 2)
3. Remove the corner guard. Drill holes where marked, making sure the holes are clean of dust and debris.
(See Figure 3)
4. Insert plastic anchors into the holes.
5. Place the corner guard back in the desired position, insert lag bolts and tighten. (See Figure 4)

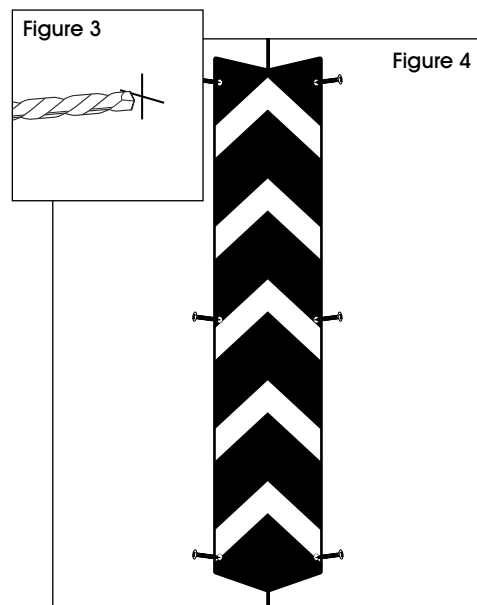
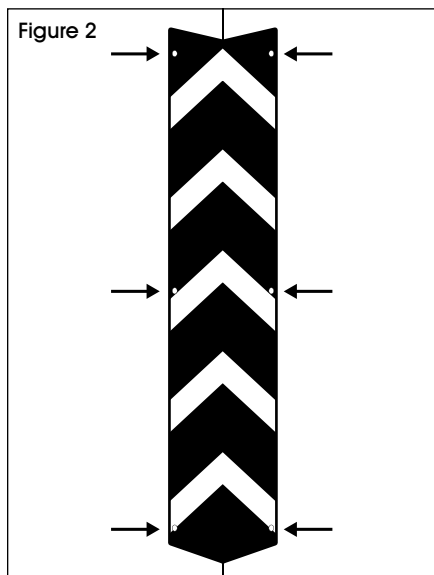
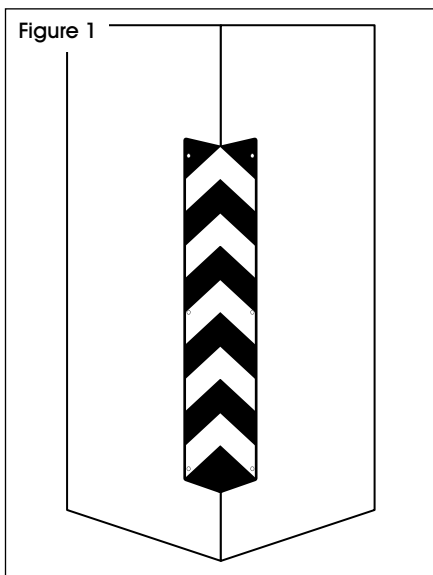

ULINE H-5175

PROTECTOR DE CAUCHO PARA ESQUINAS

800-295-5510
uline.mx

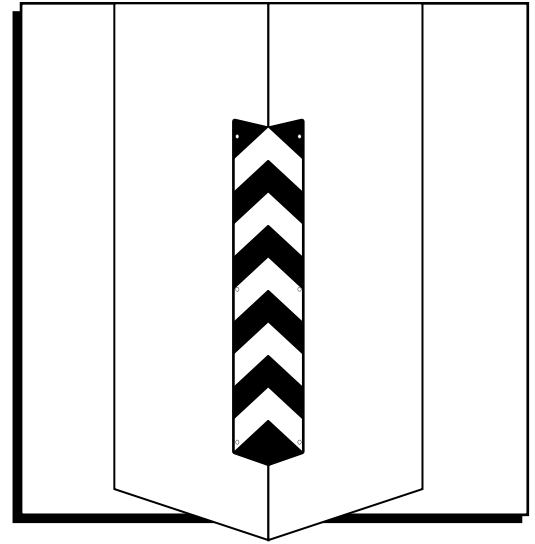

INSTALACIÓN

 **NOTA:** Accesorios de instalación no incluidos.

1. Coloque el protector de esquinas en el lugar deseado. (Vea Diagrama 1)
2. Marque en la pared las posiciones de los orificios para los tornillos (6). (Vea Diagrama 2)
3. Quite el protector de esquinas. Taladre orificios en los lugares marcados, asegurándose de que queden libres de polvo y suciedad. (Vea Diagrama 3)
4. Inserte anclajes de plástico en los orificios.
5. Vuelva a colocar el protector de esquinas en la posición deseada, inserte los tirafondos y apriételes. (Vea Diagrama 4)

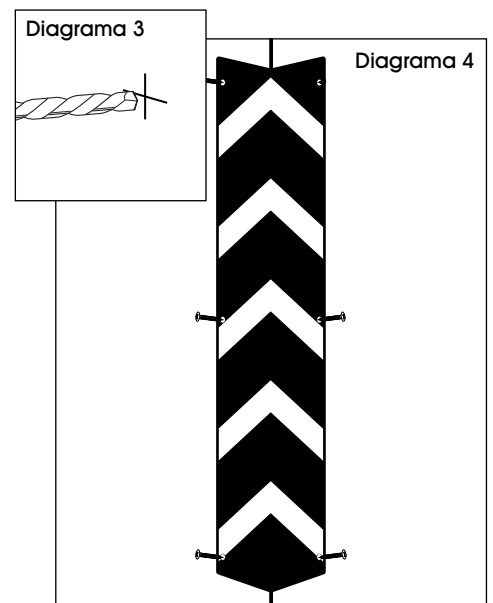
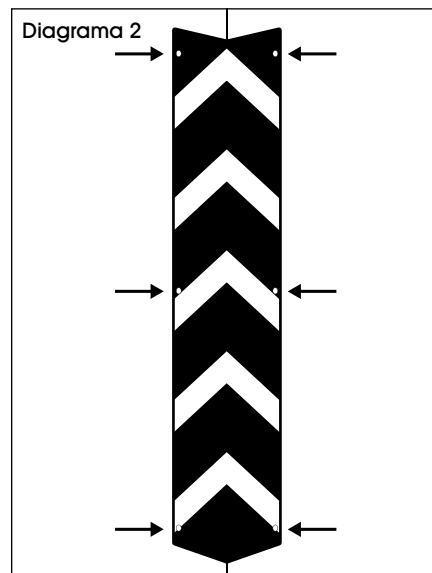
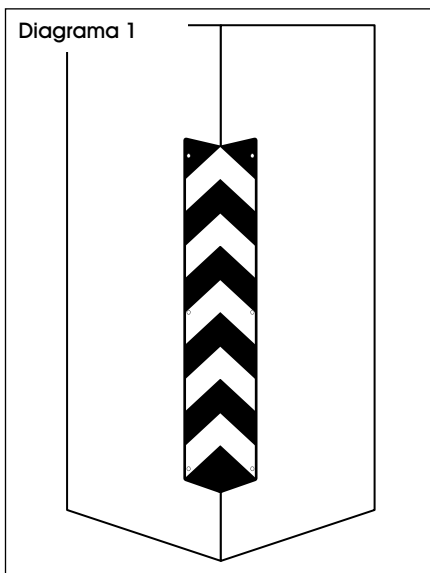

ULINE H-5175 PROTÈGE-COINS EN CAOUTCHOUC

1 800 295-5510
uline.ca

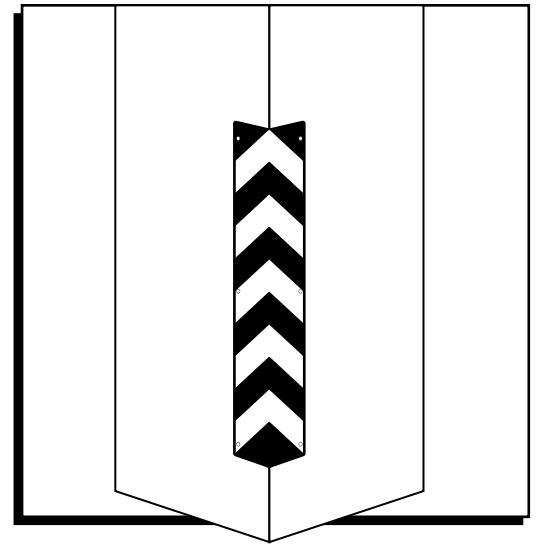

INSTALLATION

 **REMARQUE : Matériel non compris.**

1. Placez le protège-coins à l'emplacement souhaité. (Voir Figure 1)
2. Marquez les (6) emplacements de trous sur le mur là où les vis seront insérées. (Voir Figure 2)
3. Retirez le protège-coins. Percez les trous aux emplacements marqués en vous assurant que les trous sont exempts de poussières et de débris. (Voir Figure 3)
4. Insérez les ancrages en plastique dans les trous.
5. Remettez le protège-coins en place à l'emplacement souhaité, insérez les tire-fonds et serrez-les. (Voir Figure 4)

