

**ULINE** H-5713, H-7014,  
H-7871

1-800-295-5510  
uline.com

# FLOOR STAND POSTER HOLDER

## TOOL NEEDED

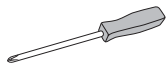

Phillips Screwdriver

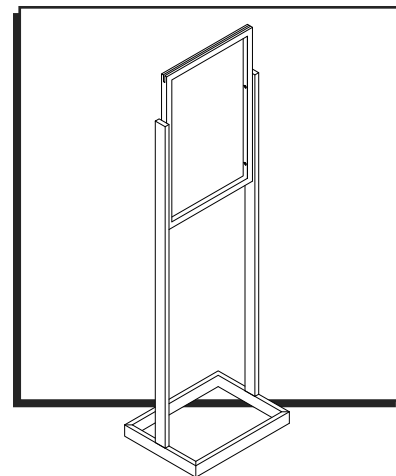

## PARTS

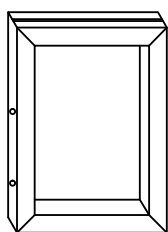

Frame

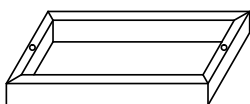

Base

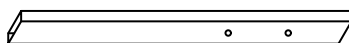

Leg x 2



Short Screw x 4  
(Shipped in Side of Legs)



Long Screw x 2  
(Shipped in Bottom of Legs)

## ASSEMBLY



**WARNING!** Screws are shipped in legs.  
Remove with Phillips screwdriver before  
proceeding with assembly.

1. Attach frame to legs using four short screws and Phillips screwdriver. (See Figure 1)



**NOTE:** Frame channel should be installed facing up.

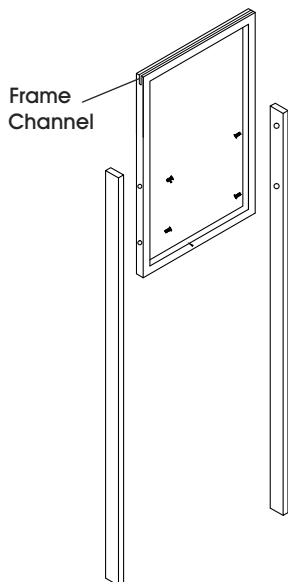

Figure 1

2. Screw base into legs using two long screws and Phillips screwdriver. (See Figure 2)

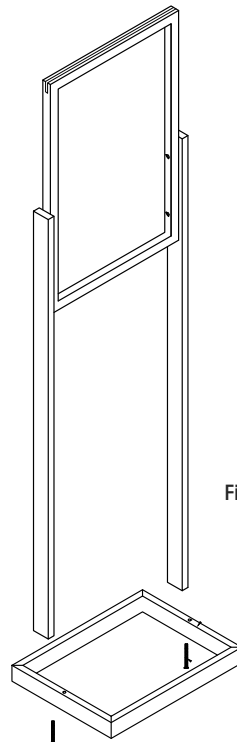
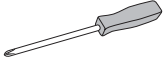
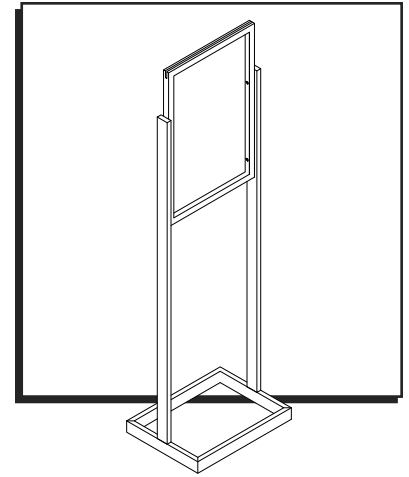
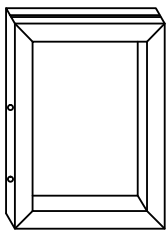

Figure 2

**PORTALETREROS  
DE PISO****HERRAMIENTA NECESARIA**

Desarmador de Cruz

**PARTES**

Armazón

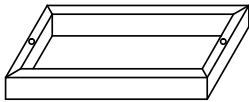

Base

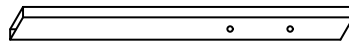

2 Patas

4 Tornillos Cortos  
(Se envían en los Laterales  
de las Patas)2 Tornillos Largos  
(Se envían en los Laterales  
de las Patas)**ENSAMBLE**

**¡ADVERTENCIA!** Los tornillos se envían en las patas. Retírelos con un desarmador de cruz antes de proceder al ensamble.

1. Acople el armazón a las patas usando cuatro tornillos cortos y un desarmador de cruz. (Vea Diagrama 1)



**NOTA:** El canal del armazón debe ser instalado apuntando hacia arriba.



Diagrama 1

2. Atornille la base a las patas usando dos tornillos largos. (Vea Diagrama 2)

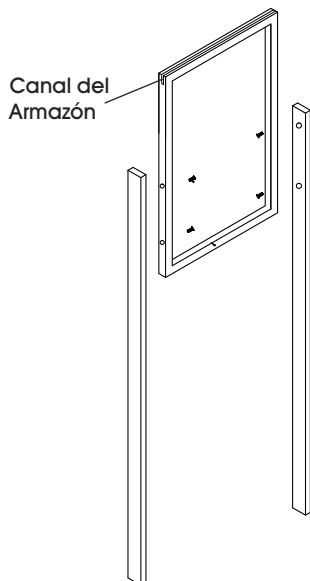

Diagrama 2

# PORTE-AFFICHE DE PLANCHER

## OUTIL REQUIS

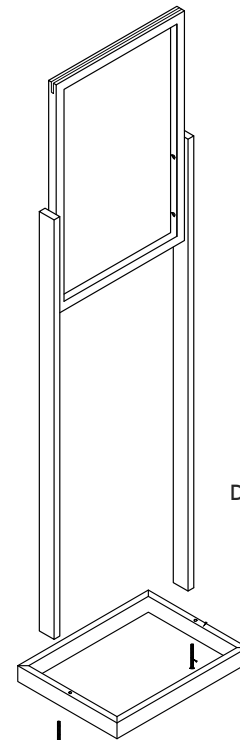
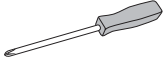

Tournevis cruciforme

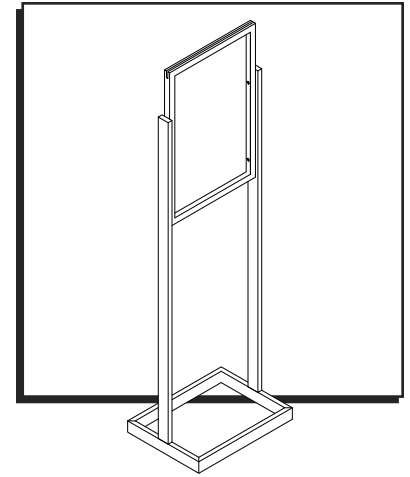

## PIÈCES

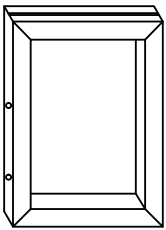

Cadre

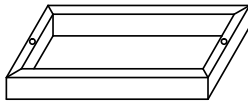

Base

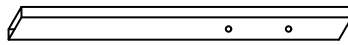

Pied x 2



Vis courte x 4  
(expédiées fixées aux pieds)



Vis longue x 2  
(expédiées fixées aux pieds)

## MONTAGE



**AVERTISSEMENT!** Les vis sont expédiées fixées aux pieds. Retirez les vis à l'aide du tournevis cruciforme avant de passer au montage.

1. Fixez le cadre aux pieds à l'aide des quatre vis courtes et du tournevis cruciforme. (Voir Figure 1)



**REMARQUE :** Le canal de cadre doit être orienté vers le haut.

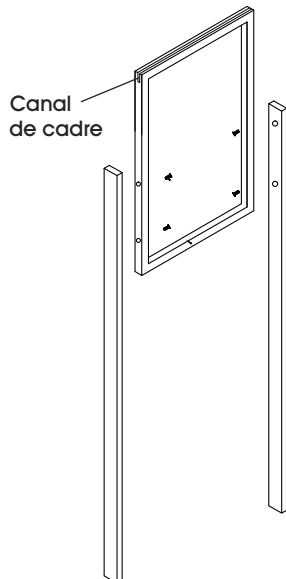

Figure 1

2. Vissez la base aux pieds à l'aide des deux vis longues et du tournevis cruciforme. (Voir Figure 2)

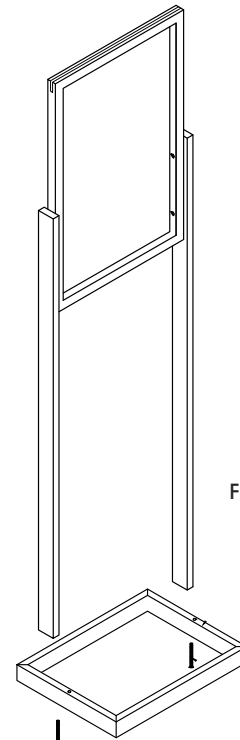

Figure 2