

# ULINE H-5823

## 3 DOOR ENCLOSED CORK BOARD

1-800-295-5510  
uline.com

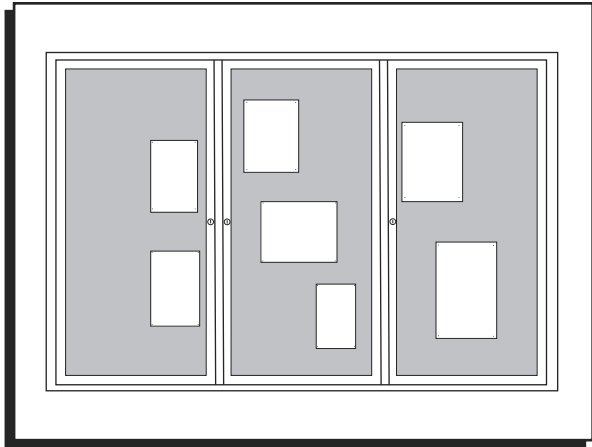

### TOOLS NEEDED



Drill

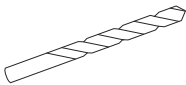

1/4" Drill Bit

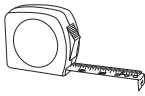

Tape Measure

## PARTS

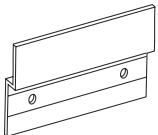

Hanging Bracket x 4

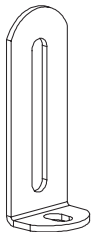

L-Bracket x 2

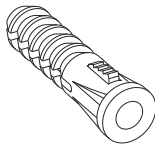

Drywall Anchor x 10

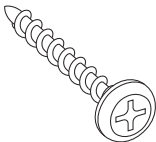

1/4" Screw x 10

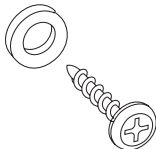

1/4" Screw and Washer x 2

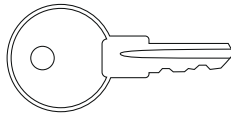

Key x 2

## TOP HANGING BRACKET MOUNTING

1. Determine board location. Position top hanging brackets 6" from outside edge of board with bracket holes 2 3/4" from top of board. (See Figure 1)

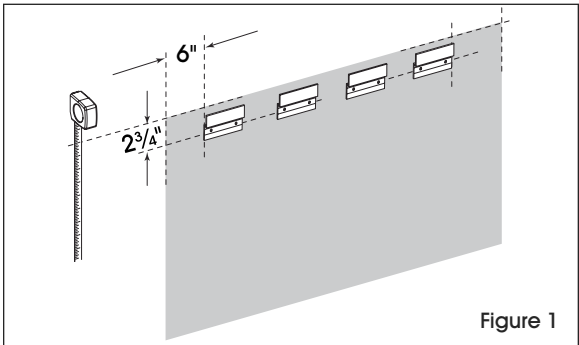

Figure 1

2. Mark wall at centers of bracket holes. (See Figure 2)
3. Drill holes for each hanger in marked locations using a 1/4" drill bit. (See Figure 3)

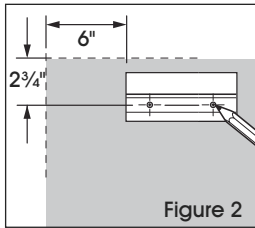

Figure 2

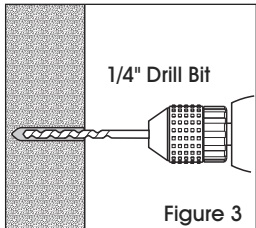

Figure 3

## TOP HANGING BRACKET MOUNTING (CONTINUED)

4. Insert wall anchors into holes, flush with the wall. Insert 1/4" screws through hanging brackets, into the wall anchors. Tighten firmly. (See Figure 4)

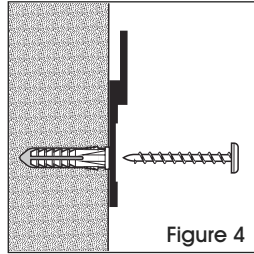
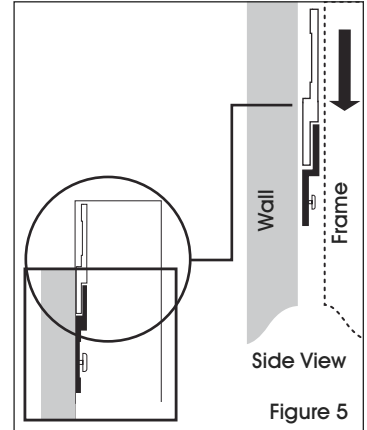

Figure 4

5. Lower board onto the top hanging brackets so built-in brackets on upper board frame are engaged. (See Figure 5)



Side View

Figure 5

## BOTTOM L-BRACKET MOUNTING

1. With board hanging on top brackets, align L-Brackets with pre-drilled holes (located on bottom of frame) and mark position. (See Figure 6)

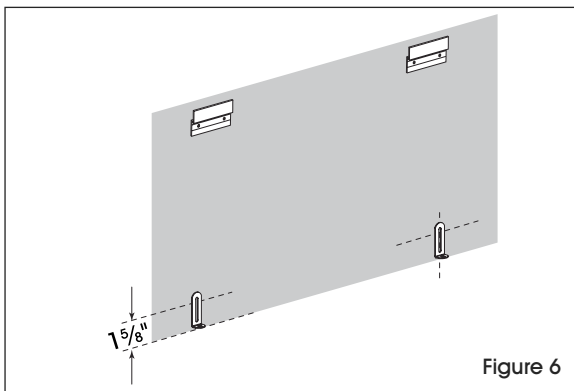

Figure 6

2. Remove board and mark wall 1 5/8" from bottom of L-Brackets. (See Figure 7)

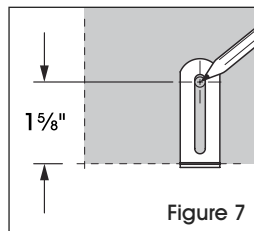

Figure 7

3. Drill holes in marked locations using 1/4" drill bit. Insert wall anchors into holes flush with wall.
4. Insert 1/4" screws through L-Brackets into wall anchors. Secure, but don't overtighten. (See Figure 8)
5. Hang board and insert 1/4" screw and washer through each L-Bracket and into predrilled hole in frame. Tighten firmly. (See Figure 9)

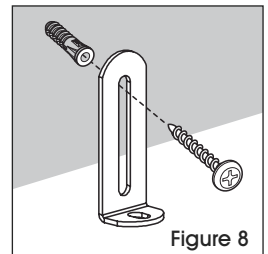

Figure 8

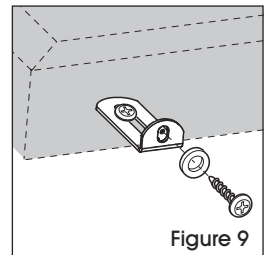

Figure 9

**ULINE**

1-800-295-5510  
uline.com

**ULINE H-5823**

# PIZARRÓN CERRADO DE CORCHO CON 3 PUERTAS

800-295-5510

uline.mx

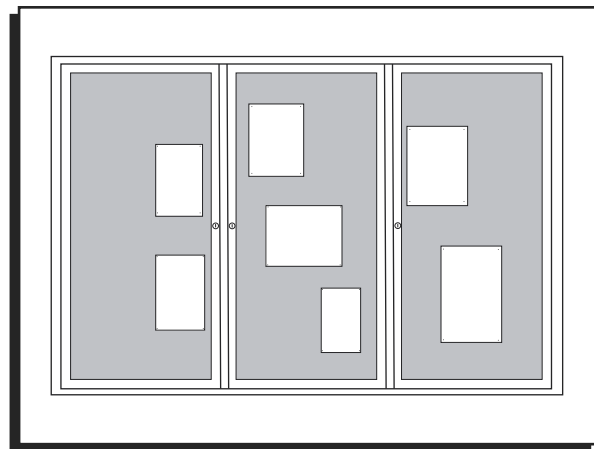

## HERRAMIENTAS NECESARIAS



Taladro

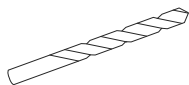

Broca de 1/4"

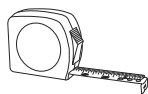

Cinta de Medir

## PARTES

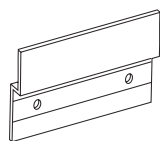

4 Soportes para Colgar

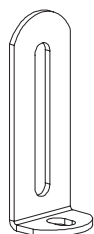

2 Soportes en "L"

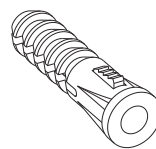

10 Taquetes para Panel de Yeso

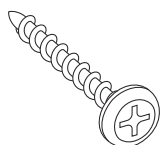

10 Tornillos de 1/4"

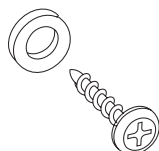

2 Tornillos de 1/4" y Rondanas

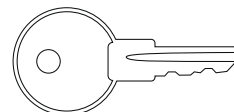

2 Llaves

## MONTAJE DE LOS SOPORTES PARA COLGAR SUPERIORES

1. Determine la posición del pizarrón. Coloque los soportes para colgar superiores a 15 cm (6") del borde externo del pizarrón con los orificios de los soportes a 7 cm (2<sup>3</sup>/<sub>4</sub>") de la parte superior del pizarrón. (Vea Diagrama 1)

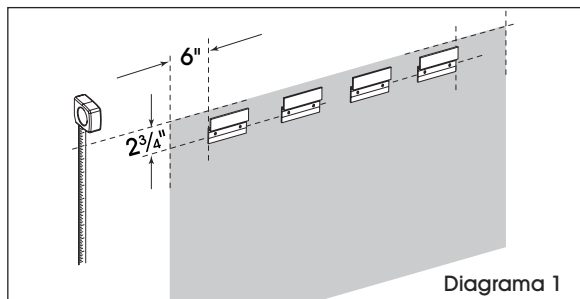

2. Marque la pared en los centros de los orificios de los soportes. (Vea Diagrama 2)
3. Perfore con una broca de 1/4" los orificios para cada soporte en las posiciones marcadas. (Vea Diagrama 3)

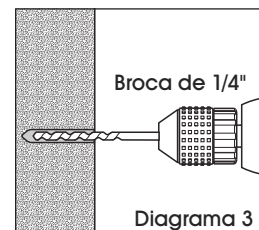
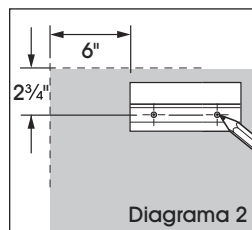

## MONTAJE DE LOS SOPORTES PARA COLGAR SUPERIORES

4. Inserte los taquetes en los orificios, a ras de la pared. Inserte los tornillos de 1/4" en los taquetes a través de los soportes para colgar. Apriete firmemente. (Vea Diagrama 4)

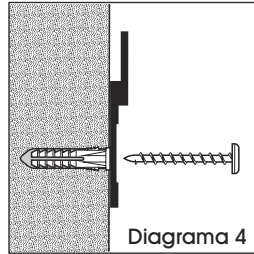

5. Baje el pizarrón sobre los soportes para colgar superiores de modo que se enganchen los soportes integrados del borde superior del marco del pizarrón. (Vea Diagrama 5)

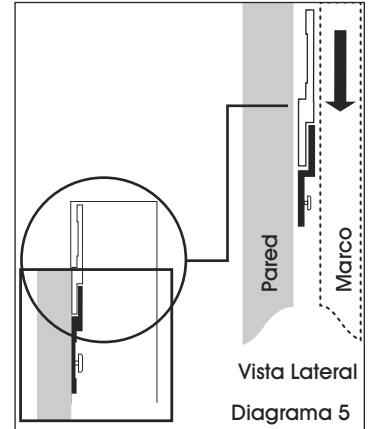

## MONTAJE DE LOS SOPORTES INFERIORES EN "L"

1. Con el pizarrón colgando de los soportes superiores, alinee los soportes en "L" con los orificios perforados previamente (ubicados en la parte inferior del marco) y marque las posición. (Vea Diagrama 6)

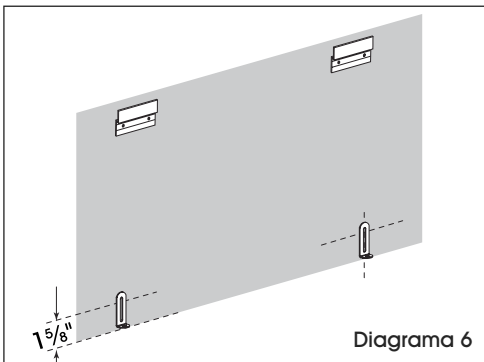

2. Retire el tablero y marque la pared a 4 cm (1 5/8") de la parte inferior de los soportes en "L". (Vea Diagrama 7)

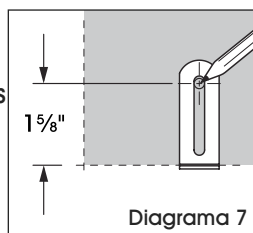

3. Perfore con una broca de 1/4" los orificios en los lugares marcados. Inserte los taquetes para pared en los orificios y verifique que queden al ras con la pared.

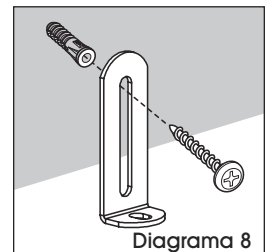

4. Inserte los tornillos de 1/4" a través de los soportes en "L" y en los taquetes. Ajústelos sin apretarlos excesivamente. (Vea Diagrama 8)

5. Cuelgue el tablero e inserte un tornillo de 1/4" con rondana a través de cada soporte en "L" y en cada orificio pretaladrado en el marco. Apriete firmemente. (Vea Diagrama 9)

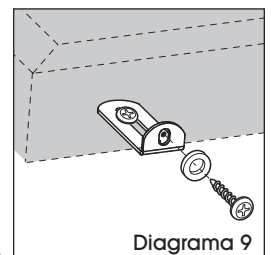

**ULINE**

800-295-5510  
uline.mx

**ULINE H-5823**

1-800-295-5510

uline.ca

# PANNEAU DE LIÈGE RENFERMÉ À 3 PORTES

## OUTILS REQUIS



Perceuse

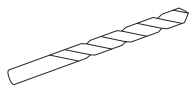

Foret de 1/4 po

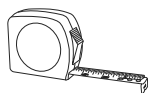

Ruban à mesurer

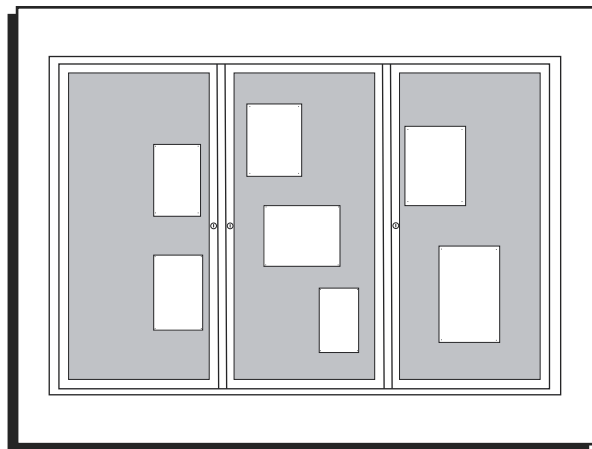

## PIÈCES

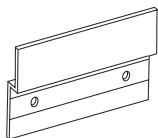

Supports de suspension x 4

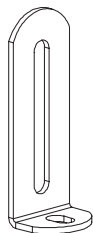

Supports en équerre x 2

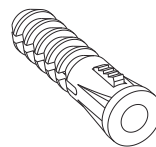

Chevilles d'ancrage pour cloisons sèches x 10

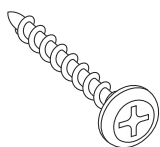

Vis de 1 1/4 po x 10

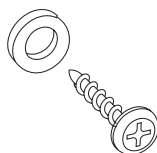

Vis de 1/4 po et rondelles x 2

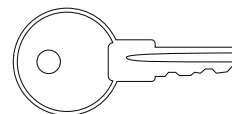

Clés x 2

## INSTALLATION DES SUPPORTS DE SUSPENSION SUPÉRIEURS

1. Déterminer l'emplacement du tableau. Placer les supports de suspension à 15 cm (6 po) de la bordure extérieure du tableau, et les trous des supports à 7 cm (2 3/4 po) du haut du tableau. (Voir Figure 1)

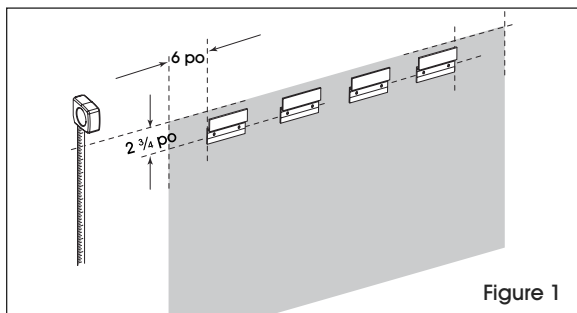

Figure 1

2. Marquer des points de repère au mur au centre des trous des supports. (Voir Figure 2)
3. Percer des trous pour chacun des supports aux endroits marqués à l'aide d'un foret de 1/4 po. (Voir Figure 3)

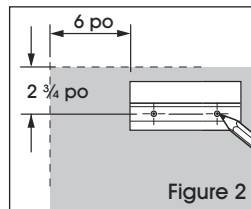

Figure 2

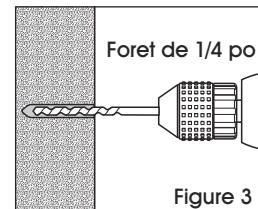
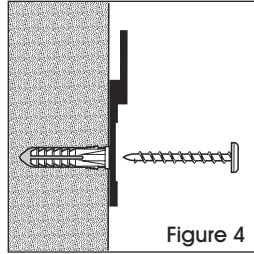

Figure 3

## INSTALLATION DES SUPPORTS DE SUSPENSION SUPÉRIEURS

4. Insérer les chevilles d'ancrage dans les trous jusqu'à ce qu'elles soient au ras du mur. Insérer ensuite les vis de 1 ¼ po dans les chevilles d'ancrage, au travers des supports de suspension. Visser fermement. (Voir Figure 4)



5. Abaisser le tableau sur le dessus des supports de suspension de façon à ce que les supports intégrés dans le cadre supérieur du tableau s'engagent. (Voir Figure 5)

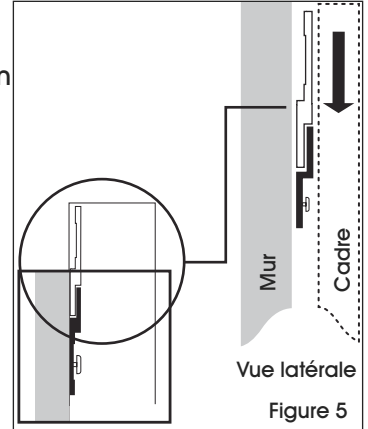

## INSTALLATION DES SUPPORTS EN ÉQUERRE INFÉRIEURS

1. Avec le tableau suspendu par les supports du haut, aligner les supports en équerre sur les trous prépercés (situés au bas du cadre) et marquer la position. (Voir Figure 6)

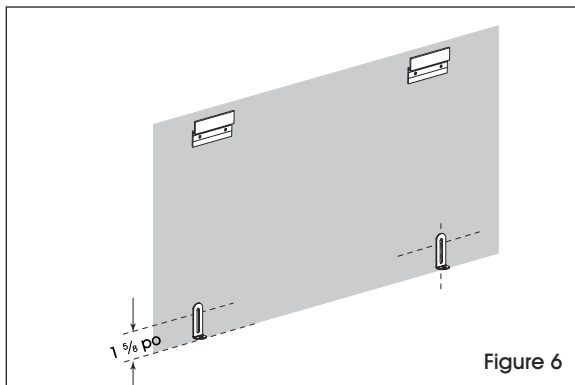

2. Retirer le tableau et marquer le mur à 16 mm (1 5/8 po) du bas des supports en équerre.

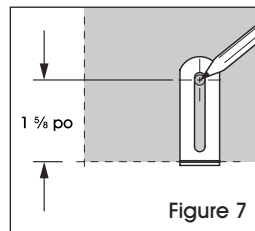

(Voir Figure 7)

3. Percer des trous aux endroits marqués à l'aide d'un foret de 1/4 po. Insérer les chevilles d'ancrage dans les trous jusqu'à ce qu'elles soient au ras du mur.
4. Insérer les vis de 1 ¼ po dans les chevilles d'ancrage, au travers des supports en équerre. Visser, mais ne pas trop serrer. (Voir Figure 8)
5. Suspendre le tableau et insérer une vis de 1/4 po et une rondelle dans les trous prépercés dans le cadre, au travers des supports en équerre. Visser fermement. (Voir Figure 9)

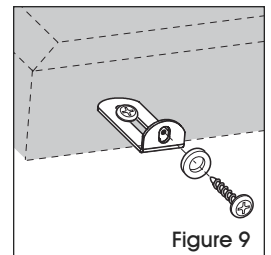
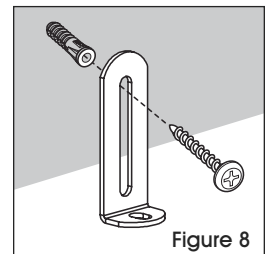

**ULINE**

1-800-295-5510  
uline.ca