

ULINE H-6703

CLEAR SCREEN – 6 x 6'

1-800-295-5510
uline.com

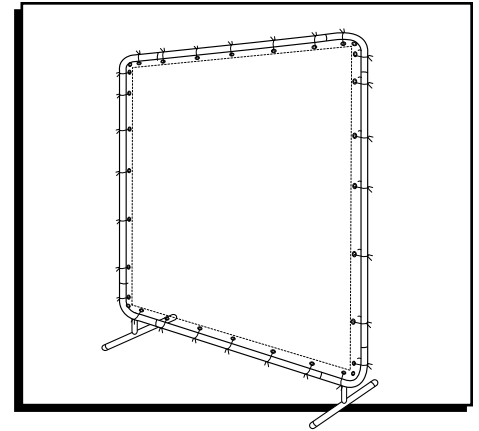

PARTS

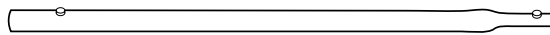

Long Tapered Tube (A) x 4

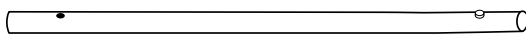

Medium Non-Tapered Tube (B) x 4

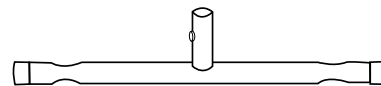

Foot (E) x 2

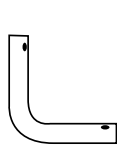

Corner (C) x 2

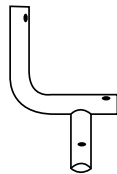

Corner with Foot Adapter (D) x 2

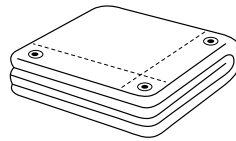

Curtain x 1



Curtain Tie x 32

ASSEMBLY

1. Assemble the top and bottom frames by connecting the medium non-tapered (B) and long tapered (A) tubes until pins snap and lock in place.
2. Assemble the left and right frames by connecting the medium non-tapered (B) and long tapered (A) tubes until pins snap and lock in place.
3. Connect the corners (C) with the top, left and right frames until pins snap and lock in place.
4. Connect the corners with foot adapters (D) to the bottom, left and right frames until pins snap and lock in place.
5. Connect a foot (E) to each corner with foot adapter (D) until pins snap and lock in place.
6. With your frame assembled, begin attaching the curtain to the frame using the curtain ties.

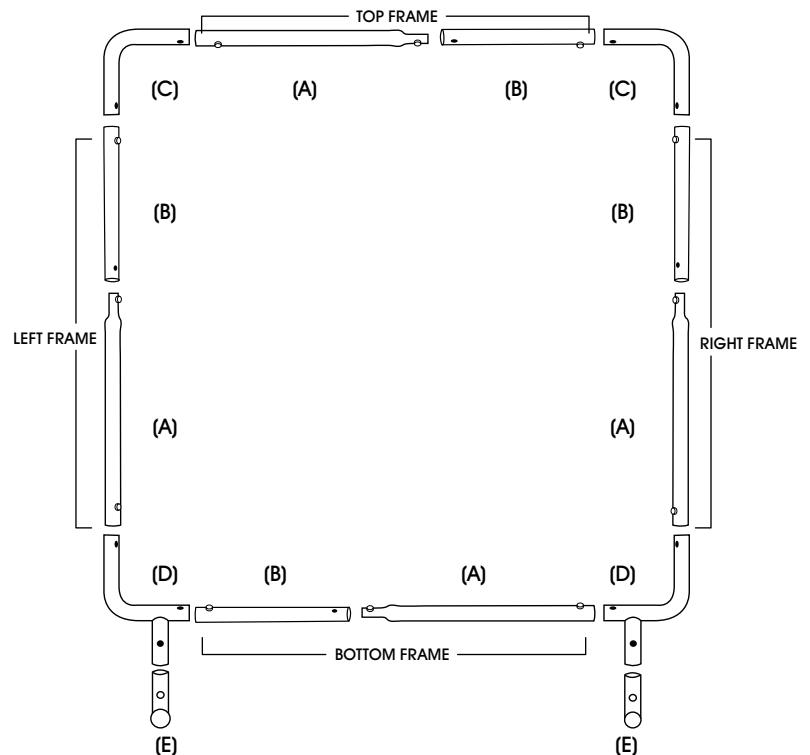

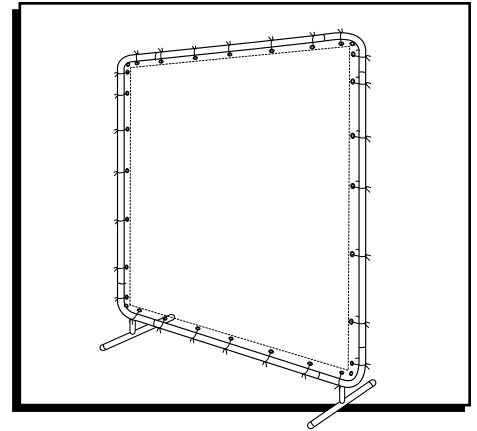
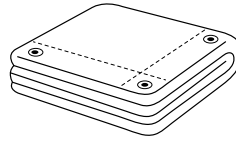
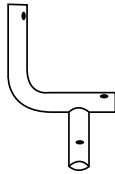
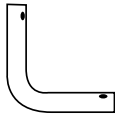
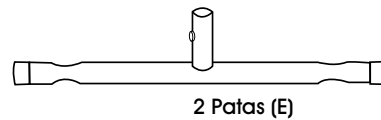
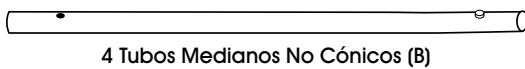
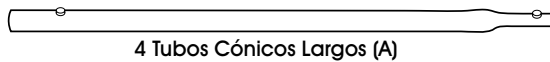
**PARTES**

2 Esquinas (C)

2 Esquinas con
Adaptadores para Pata (D)

1 Cortina

32 Cinchos para Cortina

ENSAMBLE

1. Ensamble los armazones superior e inferior conectando los tubos medianos no cónicos (B) y los tubos cónicos largos (A) hasta que los pasadores encajen en su lugar.
2. Ensamble los armazones izquierdo y derecho conectando los tubos medianos no cónicos (B) y los tubos cónicos largos (A) hasta que los pasadores encajen en su lugar.
3. Conecte las esquinas (C) a los armazones superior, izquierdo y derecho hasta que los pasadores encajen en su lugar.
4. Conecte las esquinas con adaptadores para pata (D) a los armazones inferior, izquierdo y derecho hasta que los pasadores encajen en su lugar.
5. Conecte la pata (E) a cada esquina con adaptador para pata (D) hasta que los pasadores encajen en su lugar.
6. Con su armazón ensamblado, comience a unir la cortina al armazón utilizando los cinchos para cortina.

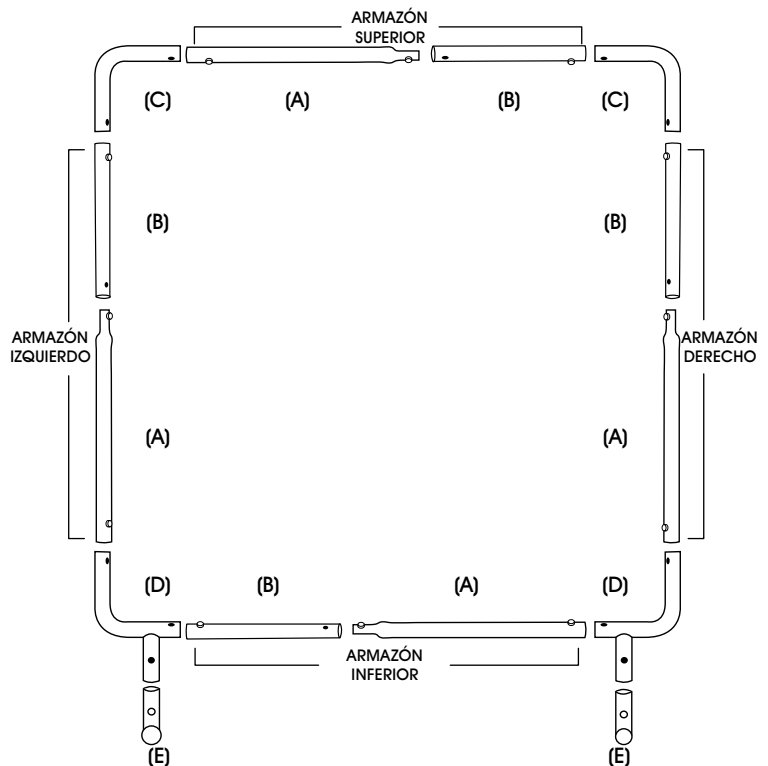

ULINE H-6703
ÉCRAN – 6 x 6 pi,
TRANSPARENT

1-800-295-5510
 uline.ca

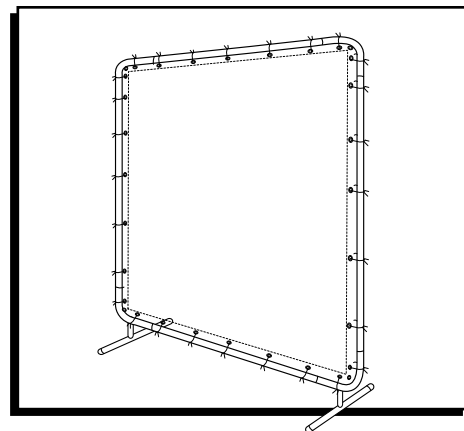

PIÈCES

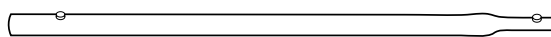

Long tube conique (A) x 4

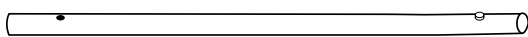

Tube moyen non conique (B) x 4

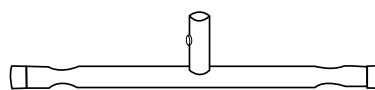

Tube de pied (E) x 2

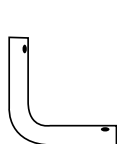

Tube de coin (C) x 2

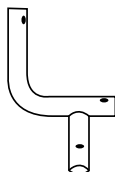

Tube de coin avec adaptateur de pied (D) x 2

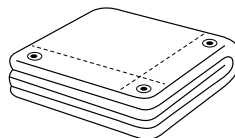

Rideau x 1



Attache de rideau x 32

MONTAGE

1. Assemblez les côtés supérieur et inférieur en rattachant le tube moyen non conique (B) avec le long tube conique (A) jusqu'à ce que les goupilles se verrouillent en place.
2. Assemblez les côtés latéraux gauche et droit en rattachant le tube moyen non conique (B) avec le long tube conique (A) jusqu'à ce que les goupilles se verrouillent en place.
3. Reliez les tubes de coin (C) avec les côtés supérieur, gauche et droit jusqu'à ce que les goupilles se verrouillent en place.
4. Connectez les tubes de coin avec adaptateur de pied (D) aux côtés inférieur, gauche et droit jusqu'à ce que les goupilles se verrouillent en place.
5. Connectez un tube de pied (E) à chaque tube de coin avec adaptateur de pied (D) jusqu'à ce que les goupilles se verrouillent en place.
6. Avec le montage du cadre maintenant terminé, commencez à installer le rideau au cadre en utilisant les attaches de rideau.

