

ULINE H-7021, H-7023
H-7024
WIRE WINE RACK

1-800-295-5510
uline.com

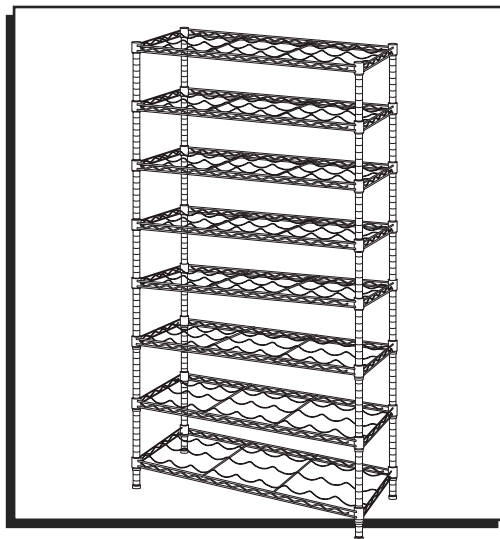

PARTS

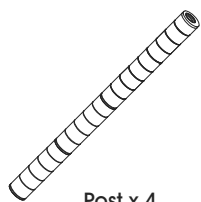

Post x 4

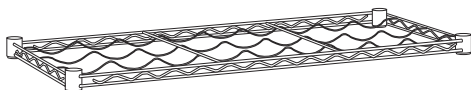

Shelf x 8
(H-7021 x 4)



Shelf Support x 32
(H-7021 x 16)



Self-Leveler x 4

INSTALLATION OF SELF-LEVELERS

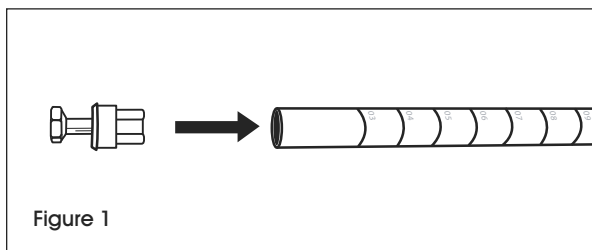

Figure 1

TO INSTALL SELF-LEVELERS

1. Make sure post is positioned as shown. (See Figure 1)
2. Insert self-leveler into open end of post.
3. Tap on ground until self-leveler slides into post.
4. Repeat steps 2 and 3 for other posts.

ASSEMBLY

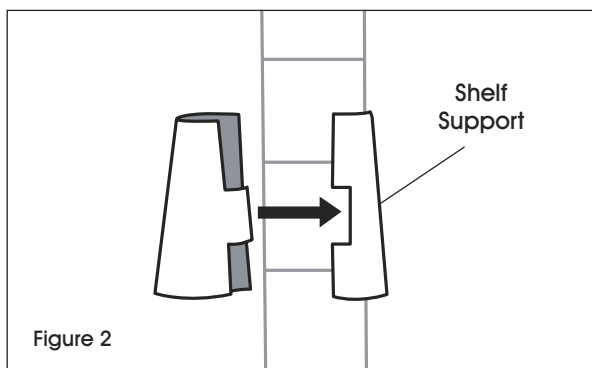

Figure 2

1. Start with the lowest shelf. Snap the interlocking pieces of a shelf support (wide end down) around the post at the lowest groove where shelf is to be located. Slide the support up or down until it snaps onto the groove. Add a shelf support to the same place on the remaining posts. (See Figure 2)



NOTE: NSF requires food service applications to keep the lowest shelf at least 6" above the floor.

ASSEMBLY CONTINUED

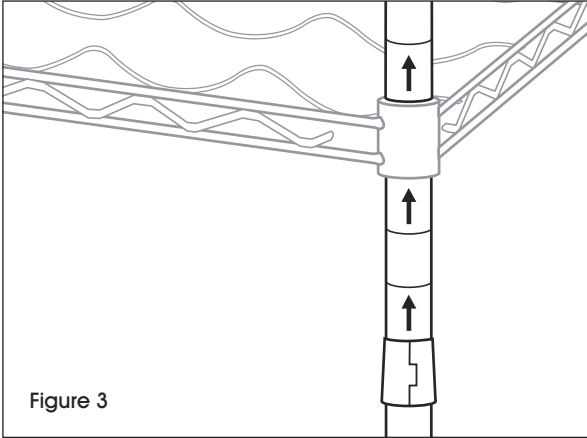

2. Slide post through underside of shelf until shelf slides firmly over supports. (See Figure 3)

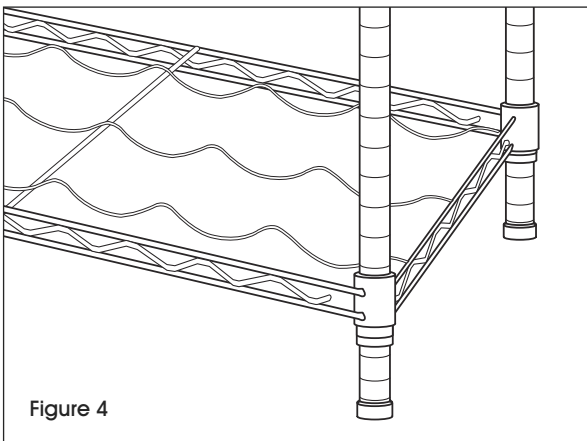

3. Stand unit upright. Gently tap shelf down to secure it. (See Figure 4)

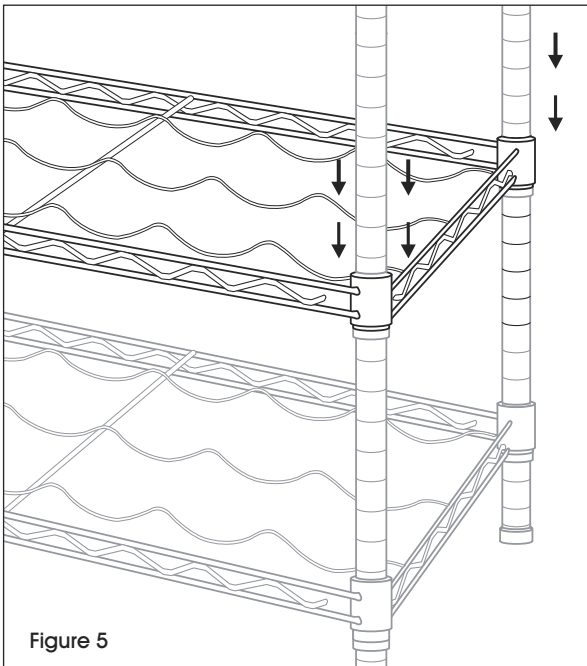

4. Determine the height of the next shelf, snap on supports then add and secure shelf. (See Figure 5)
5. Repeat Step 4 to add the remaining shelves.

ULINE

1-800-295-5510
uline.com

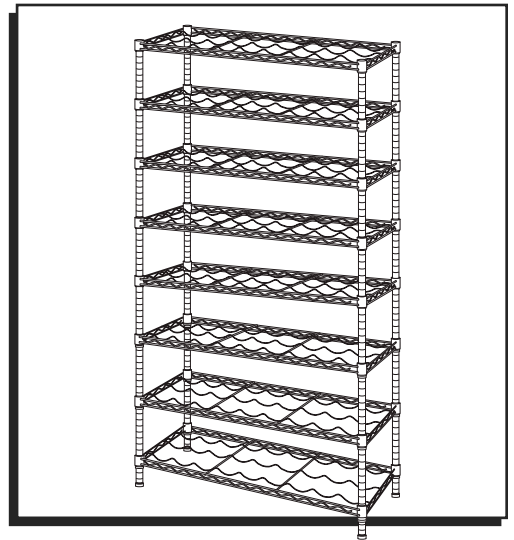

PARTES

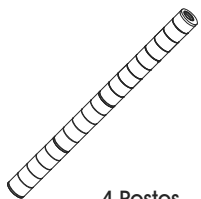

4 Postes

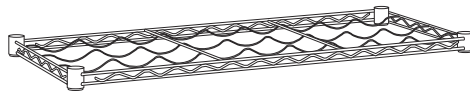

8 Repisas
(H-7021 x 4)



32 Sets de Soportes de Repisa
(H-7021 x 16)

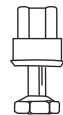

4 Autoniveladores

INSTALACIÓN DE AUTONIVELADORES Y RUEDAS OPCIONALES



Diagrama 1

PARA INSTALAR AUTONIVELADORES

1. Asegúrese que los postes estén posicionados como se muestra. (Vea Diagrama 1)
2. Inserte el autonivelador dentro del extremo abierto del poste.
3. Presione en el suelo hasta que el autonivelador se meta dentro del poste.
4. Repita los pasos 2 y 3 para los otros postes.

ENSAMBLE

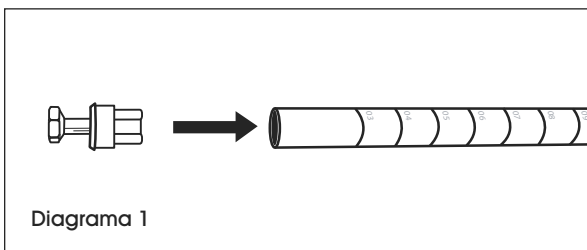

Diagrama 2

1. Comience con la repisa más baja. Embone las piezas del soporte para repisa (la parte ancha hacia abajo) alrededor del poste en la ranura más baja donde la repisa va a ser colocada. Deslice el soporte hacia arriba o abajo hasta que embone en la ranura. Agregue un soporte para repisa en el mismo lugar en los postes restantes. (Vea Diagrama 2)

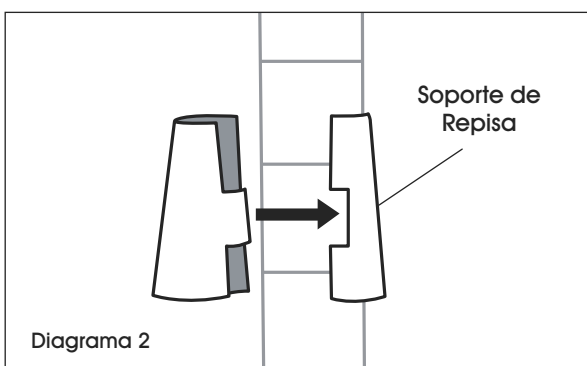

NOTA: NSF requiere que para aplicaciones en servicio de alimentos mantenga la repisa más baja al menos a 15 cm (6") sobre el piso.

CONTINUACIÓN DE ENSAMBLE

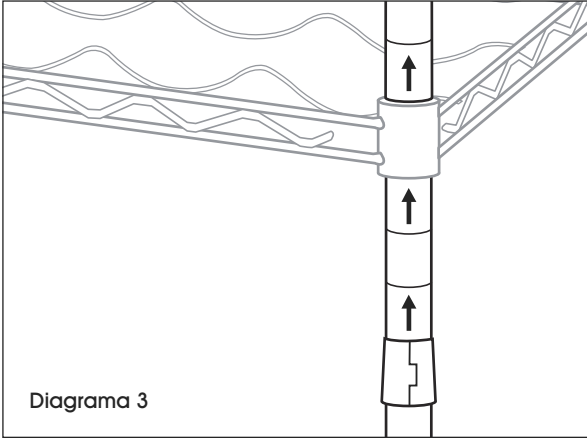

2. Deslice el poste a través de la parte inferior de la repisa hasta que la repisa se deslice firmemente por encima de los soportes. (Vea Diagrama 3)

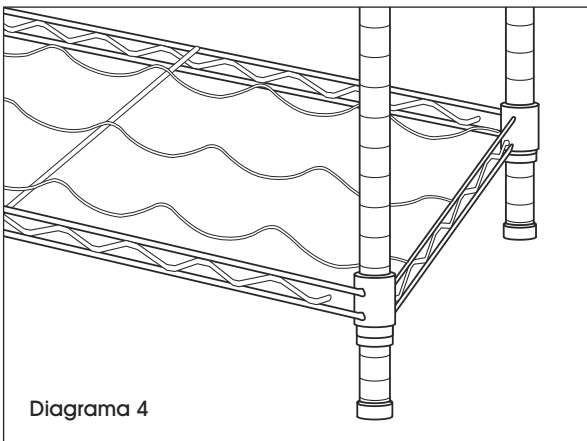

3. Pare la unidad. Presione ligeramente la repisa hacia abajo para asegurarla. (Vea Diagrama 4)

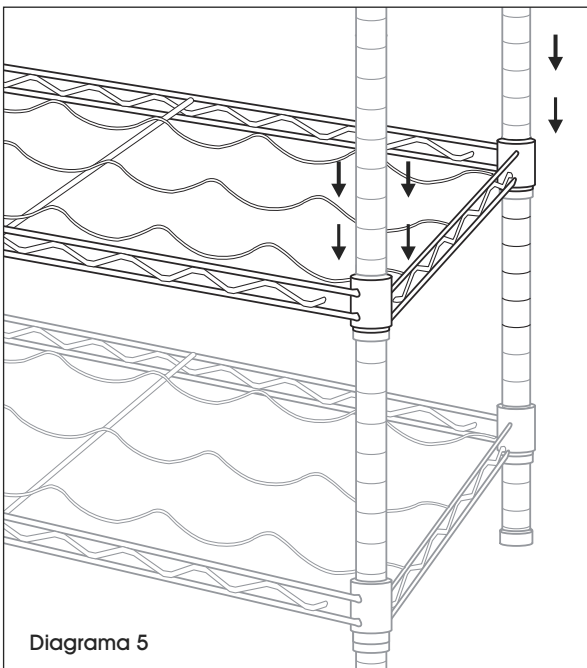

4. Determine la altura de la siguiente repisa, deslícela en los soportes, luego agregue y asegure la repisa. (Vea Diagrama 5)
5. Repita el Paso 4 para agregar las repisas restantes.

ULINE

800-295-5510
uline.mx

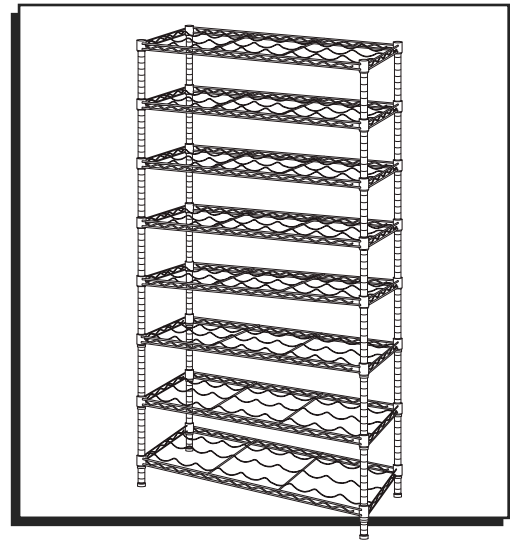

PIÈCES

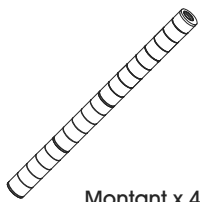

Montant x 4

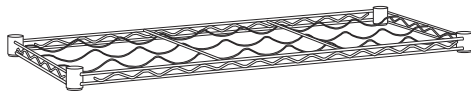

Tablette x 8
(H-7021 x 4)



Ensemble de support
de tablette x 32
(H-7021 x 16)

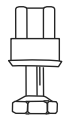

Dispositif
d'autonivellement x 4

INSTALLATION DES DISPOSITIFS D'AUTONIVELLEMENT

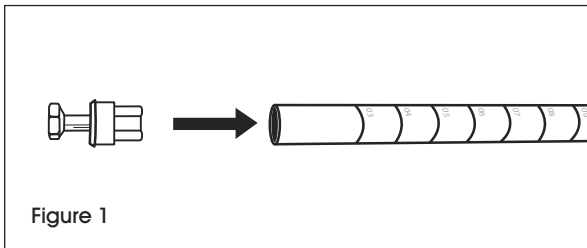

Figure 1

POUR INSTALLER LES DISPOSITIFS D'AUTONIVELLEMENT

1. Assurez-vous que le montant est placé comme illustré. (Voir Figure 1)
2. Insérez le dispositif d'autonivellement dans l'extrémité ouverte du montant.
3. Tapez sur le sol jusqu'à ce que le dispositif d'autonivellement soit inséré dans le montant.
4. Répétez les étapes 2 et 3 pour tous les autres montants.

MONTAGE

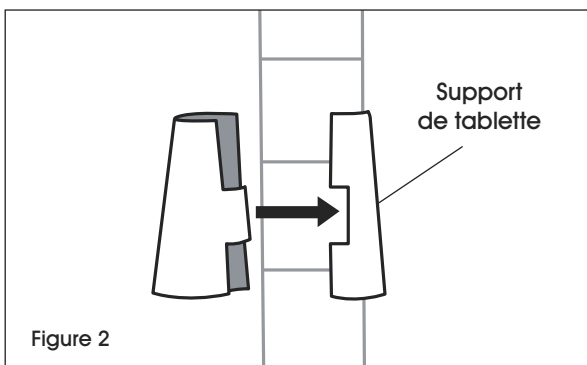

Figure 2

1. Commencez par la tablette la plus basse. Enclenchez les pièces emboîtables d'un support de tablette (extrémité la plus large vers le bas) autour du montant, au niveau de la rainure la plus basse où la tablette doit être installée. Faites glisser le support vers le haut ou vers le bas jusqu'à ce qu'il s'enclenche sur la rainure. Ajoutez un support de tablette au même emplacement sur les montants restants. (Voir Figure 2)



REMARQUE : Pour les applications alimentaires, la NSF stipule que la tablette la plus basse doit se trouver à 15 cm (6 po) du sol.

MONTAGE SUITE

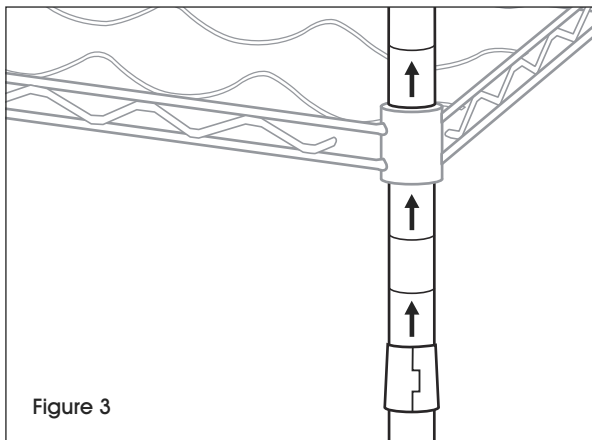

2. Insérez le montant par le dessous de la tablette jusqu'à ce que la tablette glisse fermement sur les supports. (Voir Figure 3)

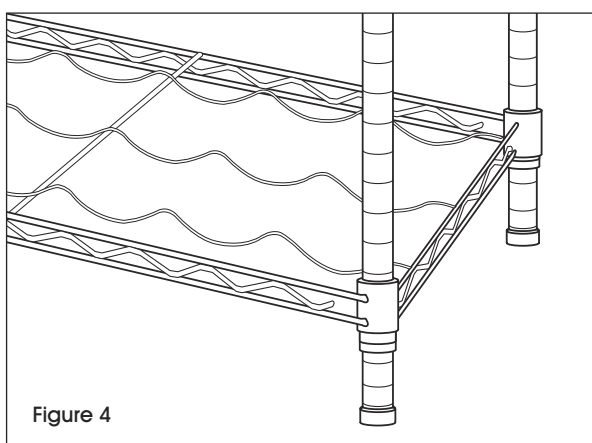

3. Placez l'unité à la verticale. Tapotez délicatement la tablette vers le bas pour la fixer. (Voir Figure 4)

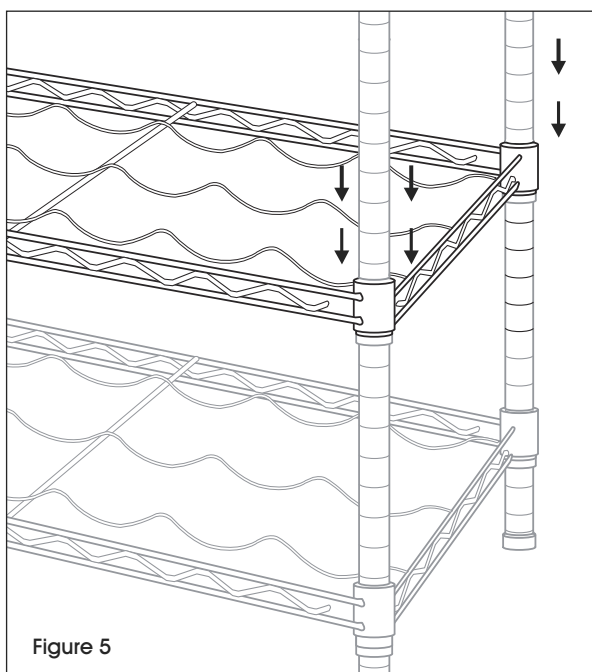

4. Déterminez la hauteur de la tablette suivante, enclenchez les supports, puis ajoutez et fixez la tablette. (Voir Figure 5)
5. Répétez l'étape 4 pour ajouter les tablettes restantes.

ULINE

1-800-295-5510
uline.ca