

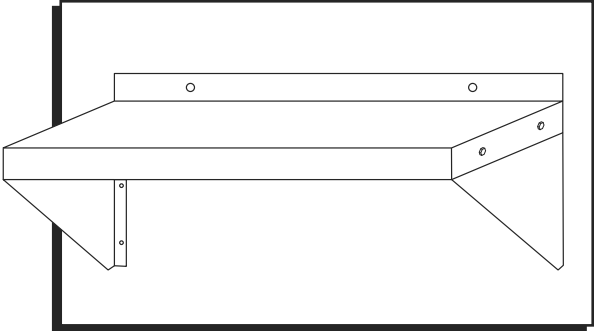

H-7498, H-7499
H-7500, H-11284

SOLID STAINLESS STEEL WALL MOUNT SHELVING

1-800-295-5510
uline.com



TOOLS NEEDED



Cordless Drill



1/4" Drill Bit



10 mm Wrench

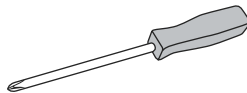

Phillips Screwdriver

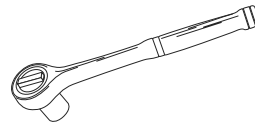

10 mm Socket Wrench



Step Ladder
(Optional)

PARTS

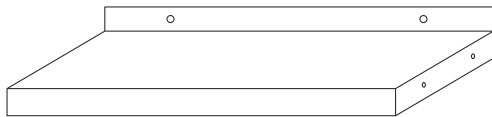

Shelf x 1

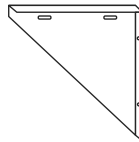

Left Shelf Support x 1

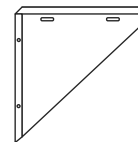

Right Shelf Support x 1

Wall-Mount Hardware Kit



Anchor x 6
(x 7 for 60")

Screw x 6
(x 7 for 60")



Phillips Head
Bolt x 4



Acorn Nut x 4



Washer x 4



Lock Washer x 4

INSTALLATION

Attach left and right shelf supports to shelf using bolt, lock washer, washer and acorn nut. Insert bolt through the shelf and shelf support holes and tighten acorn nut using a 10 mm wrench. (See Figure 1)

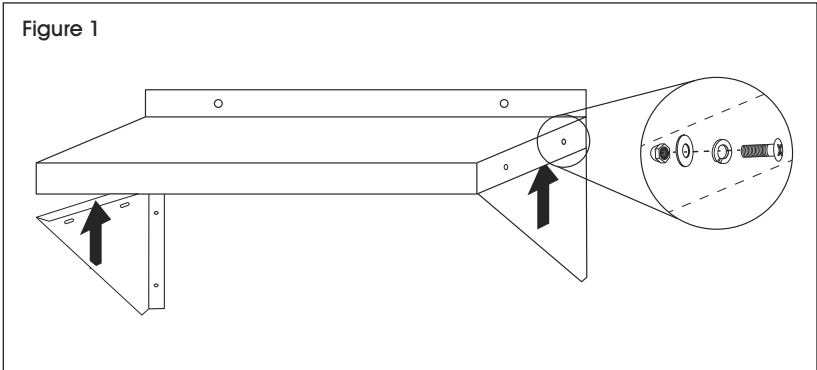

INSTALLATION CONTINUED

24", 36" AND 48" INSTALLATION

Mark hole where screws are to be located. Drill holes using 1/4" drill bit. Mount shelf to wall with six anchors and six screws using a Phillips screwdriver. (See Figure 2)

Figure 2

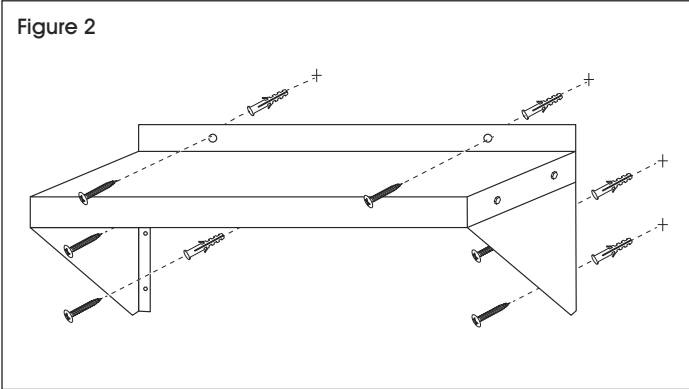

60" INSTALLATION

Mark holes where screws are to be located. Drill holes using 1/4" drill bit. Mount shelf to wall with seven screws and seven anchors using a Phillips screwdriver. (See Figure 3)

Figure 3

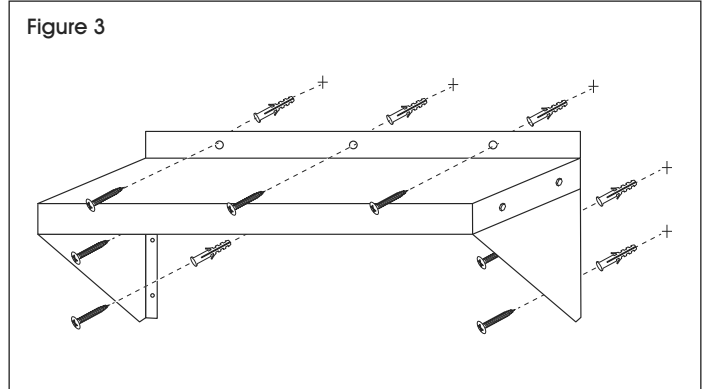



H-7498, H-7499
H-7500, H-11284

ESTANTERÍA DE ACERO INOXIDABLE SÓLIDA PARA PARED

800-295-5510
uline.mx

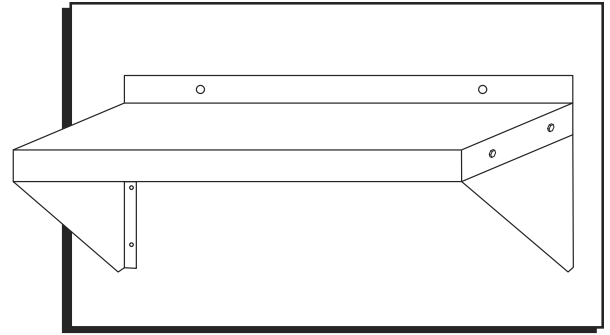

HERRAMIENTAS NECESARIAS



Taladro Inalámbrico



Broca de 1/4"



Llave de 10 mm

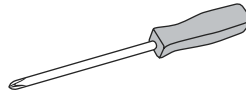

Desarmador de Cruz

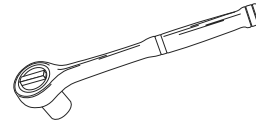

Llave de Dado de
10 mm



Escalera
(Opcional)

PARTES

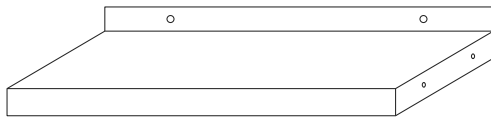

1 Repisa

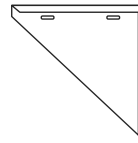

1 Soporte Izquierdo
para Repisa

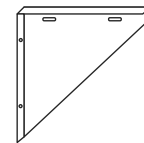

1 Soporte Derecho para
Repisa

Kit de Tornillería de
Instalación en Pared

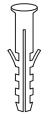

6 Anclajes
(7 para 60")

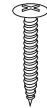

6 Tornillos
(7 para 60")



4 Pernos
con Cabeza
de Cruz



4 Tuercas
con Punta de
Bellota



4 Rondanas



4 Rondanas de
Bloqueo

INSTALACIÓN

Fije los soportes para repisas izquierdo y derecho usando perno, rondana de bloqueo, rondana y tuerca con punta de bellota. Inserte el perno a través de los orificios de la repisa y los soportes para repisa y ajuste la tuerca con punta de bellota usando una llave de 10 mm. (Vea Diagrama 1)

Diagrama 1

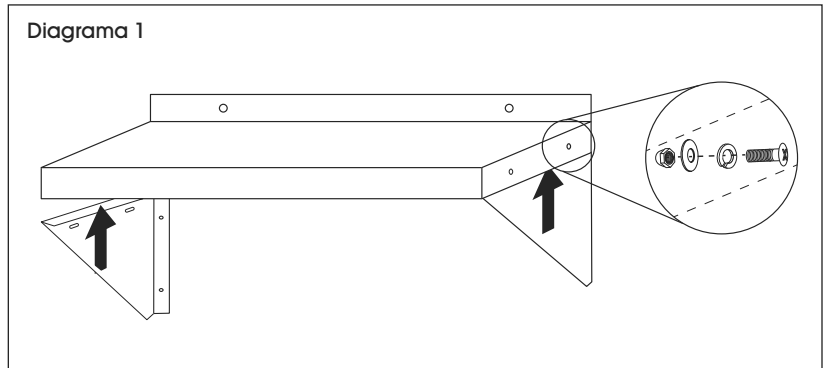

CONTINUACIÓN DE INSTALACIÓN

INSTALACIÓN PARA 24", 36" Y 48"

Marque los orificios en los que se colocarán los tornillos. Taladree los orificios utilizando broca de 1/4". Instale la repisa en la pared con seis anclajes y seis tornillos utilizando un desarmador de cruz. (Vea Diagrama 2)

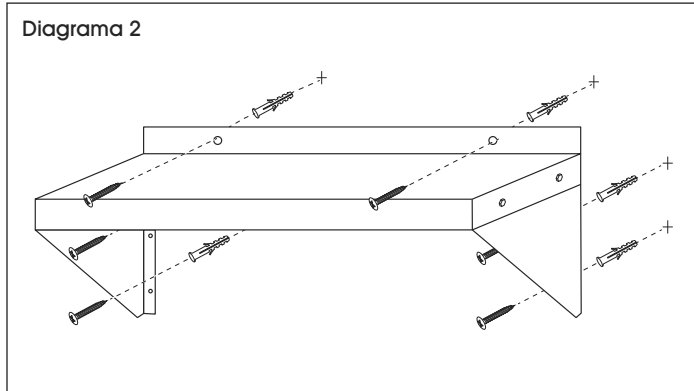

INSTALACIÓN PARA 60"

Marque los orificios en los que los tornillos se colocarán. Taladree orificios utilizando broca de 1/4". Instale la repisa en la pared con siete anclajes y siete tornillos utilizando un desarmador de cruz. (Vea Diagrama 3)

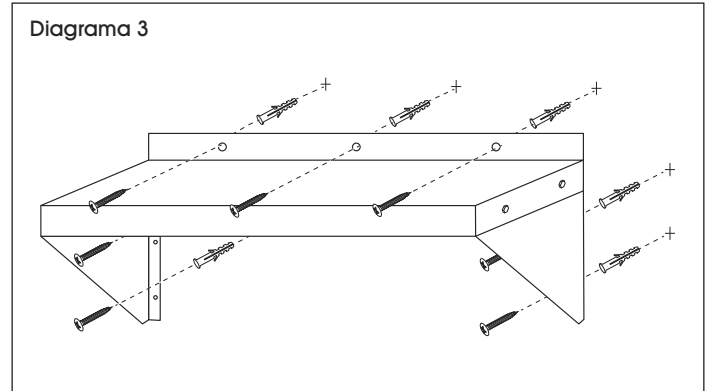

ULINE

800-295-5510
uline.mx

ULINE H-7498, H-7499
H-7500, H-11284

RAYONNAGE À FIXATION MURALE EN ACIER INOXYDABLE MASSIF

1-800-295-5510
uline.ca

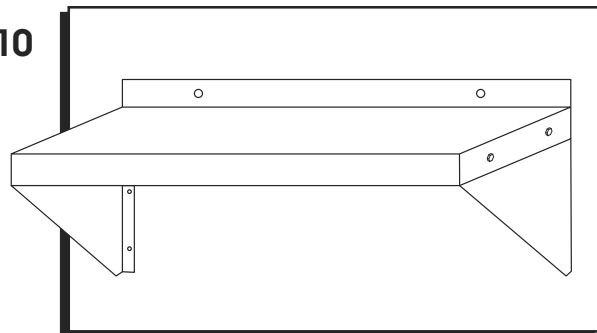

OUTILS REQUIS



Perceuse sans fil



Mèche de perceuse de 1/4 po



Clé de 10 mm

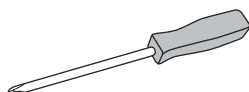

Tournevis cruciforme

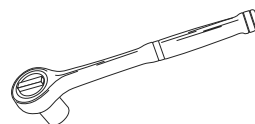

Clé à douille de 10 mm



Escabeau (facultatif)

PIÈCES

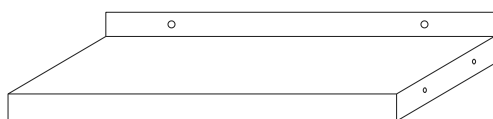

Tablette x 1

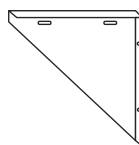

Console de tablette gauche x 1

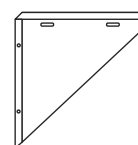

Console de tablette droite x 1

MATÉRIEL D'INSTALLATION POUR FIXATION MURALE

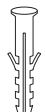

Ancrage x 6
(x 7 pour tablette (x 7 pour tablette de 60 po))

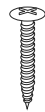

Vis x 6
(x 7 pour tablette (x 7 pour tablette de 60 po))



Boulon cruciforme x 4



Écrou borgne x 4



Rondelle x 4



Rondelle de blocage x 4

INSTALLATION

Fixez les consoles gauche et droite à la tablette à l'aide d'un boulon, d'une rondelle de blocage, d'une rondelle et d'un écrou borgne. Insérez le boulon à travers la tablette et les trous de la console, puis serrez l'écrou borgne à l'aide d'une clé de 10 mm. (Voir Figure 1)

Figure 1

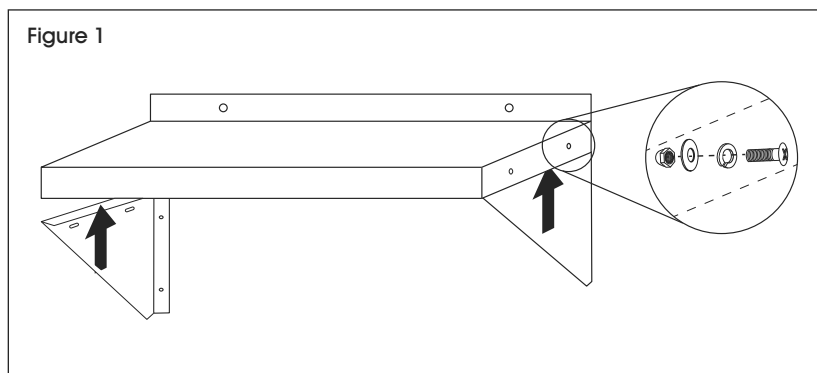

INSTRUCTIONS SUITE

INSTALLATION DE TABLETTE DE 24 PO, 36 PO ET 48 PO

Marquez l'emplacement des trous à percer. Percez les trous en utilisant une mèche de perceuse de 1/4 po. Fixez la tablette au mur en utilisant six ancrages, six vis et un tournevis cruciforme. (Voir Figure 2)

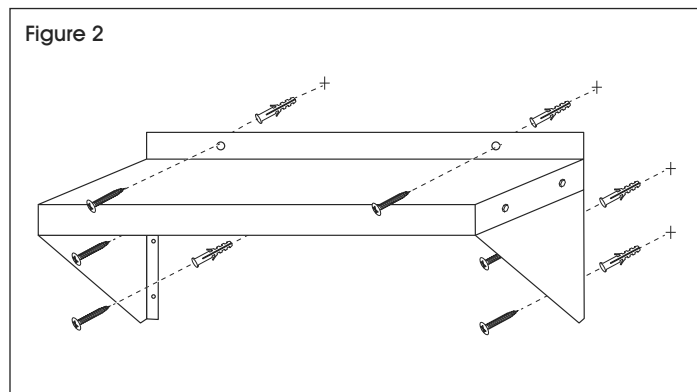

INSTALLATION DE TABLETTE DE 60 PO

Marquez l'emplacement des trous à percer. Percez les trous en utilisant une mèche de perceuse de 1/4 po. Fixez la tablette au mur en utilisant sept ancrages, sept vis et un tournevis cruciforme. (Voir Figure 3)

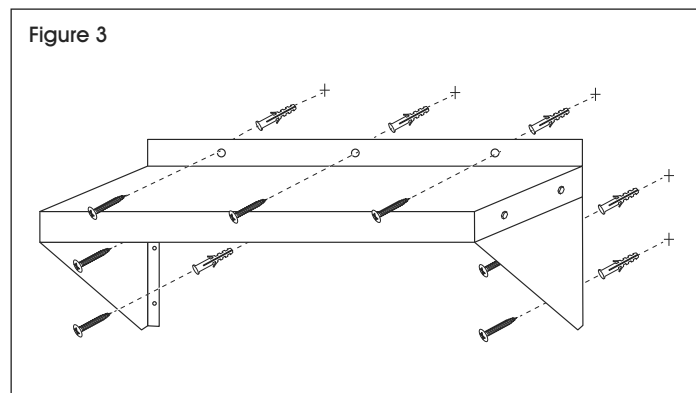

ULINE

1-800-295-5510
uline.ca