

# ULINE H-7863 COAT TREE

1-800-295-5510  
uline.com

Para Español, vea páginas 3-4.  
Pour le français, consulter les pages 5-6.

## TOOLS NEEDED



Rubber Mallet



Wrench  
(included)

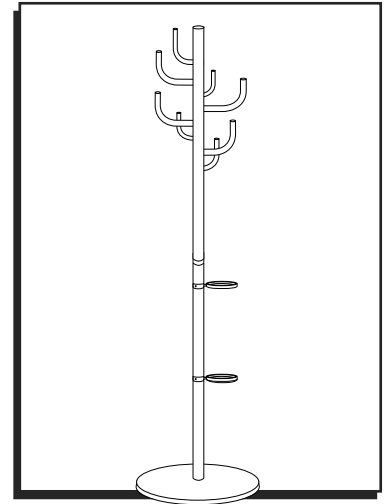

## PARTS

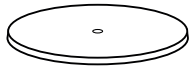

Base x 1

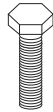

Bolt x 1

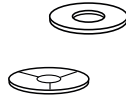

Connecting Plate x 2



Connecting Ring x 1



Connecting Screw x 1



Coat Hook x 8

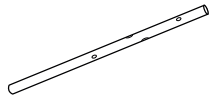

Upper Vertical  
Pole x 1

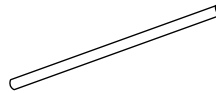

Lower Vertical  
Pole x 1



Umbrella Ring x 2



Umbrella Tray x 1

## ASSEMBLY

1. Screw connecting screw into top of lower vertical pole. Attach connecting ring to connecting screw. Slide upper vertical pole into connecting ring to attach to lower vertical pole. (See Figure 1)

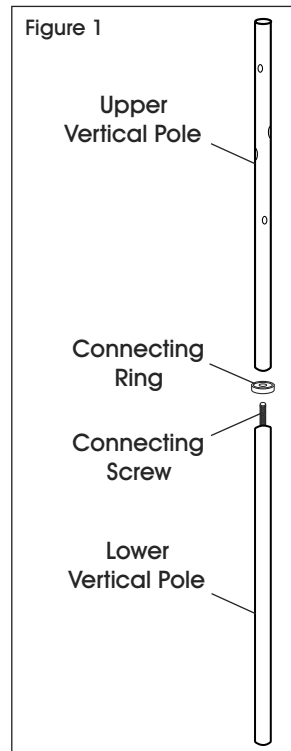

2. Place assembled pole over one connecting plate and position over hole on top of base. Use bolt to attach remaining connecting plate to bottom of base, using wrench to tighten to lower vertical pole. (See Figure 2)

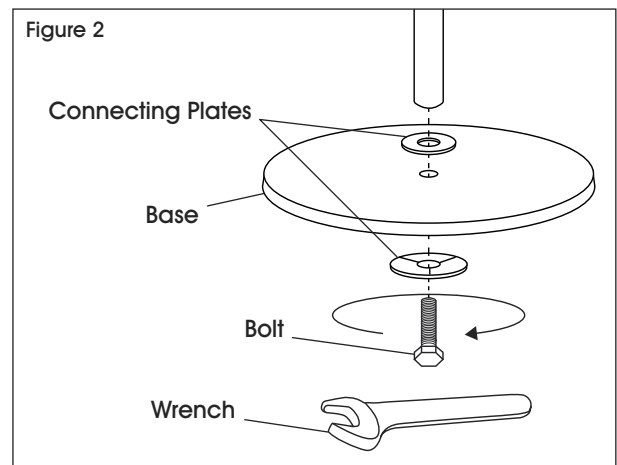

## ASSEMBLY CONTINUED

- Slide umbrella rings down vertical posts. Position at desired height. Place umbrella tray in bottom umbrella ring. (See Figure 3)

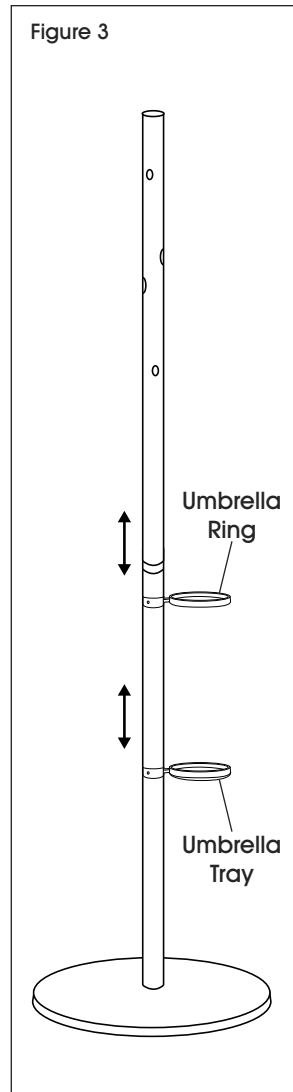

- Use mallet to secure coat hooks in place to complete assembly. (See Figure 4)

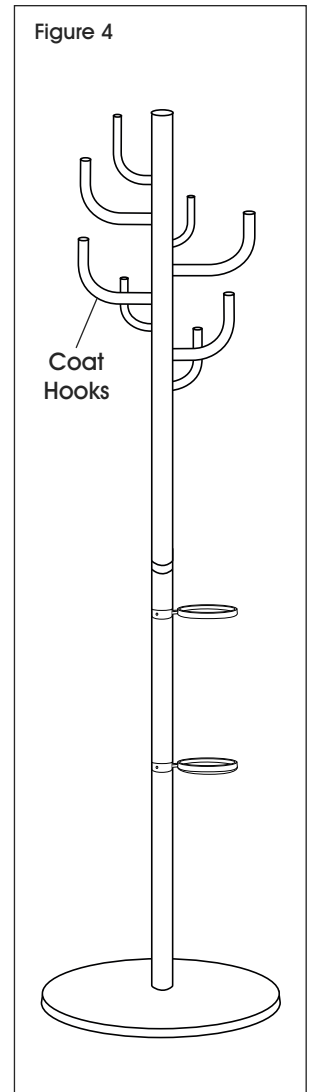

**ULINE**

1-800-295-5510  
uline.com

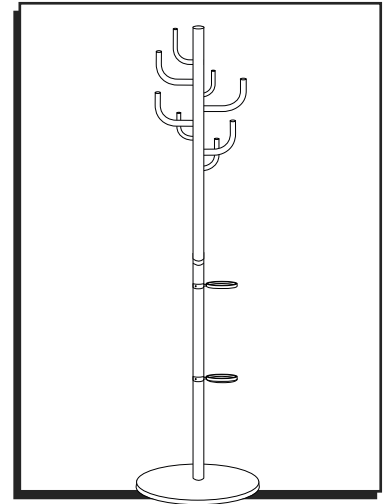

**HERRAMIENTAS NECESARIAS**



**PARTES**

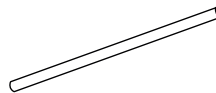
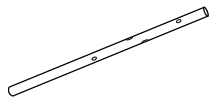
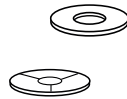
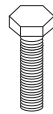
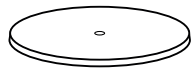

**ENSAMBLE**

1. Enrosque el tornillo de conexión en la parte superior del poste inferior. Fije el anillo de conexión al tornillo de conexión. Deslice el poste superior en el anillo de conexión para fijarlo al poste inferior. (Vea Diagrama 1)

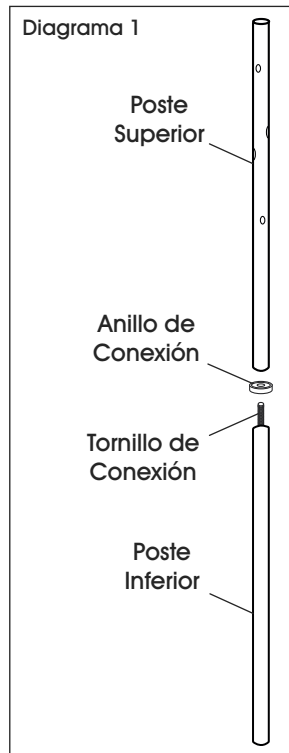

2. Coloque el poste ensamblado sobre una placa de conexión y colóquelo sobre el orificio en la parte superior de la base. Use el perno para fijar la placa de conexión restante a la parte inferior de la base usando la llave para apretarla al poste inferior. (Vea Diagrama 2)

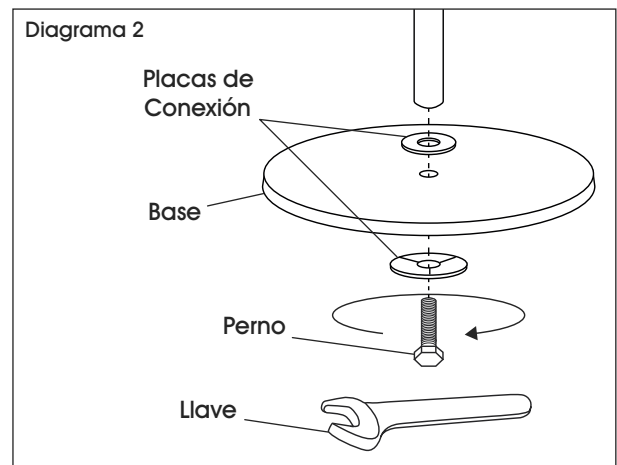

## CONTINUACIÓN DEL ENSAMBLE

3. Deslice los anillos para paraguas por los postes. Colóquelos a la altura deseada. Coloque la bandeja para paraguas en el anillo inferior. (Vea Diagrama 3)

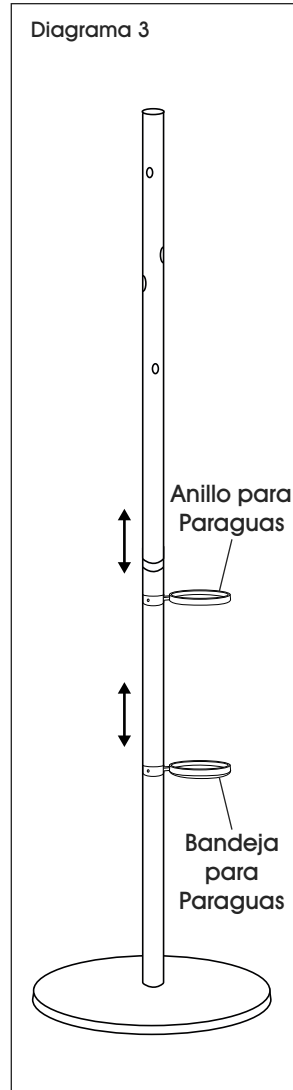

4. Para terminar el ensamble use el mazo para fijar los ganchos para abrigos en su lugar. (Vea Diagrama 4)

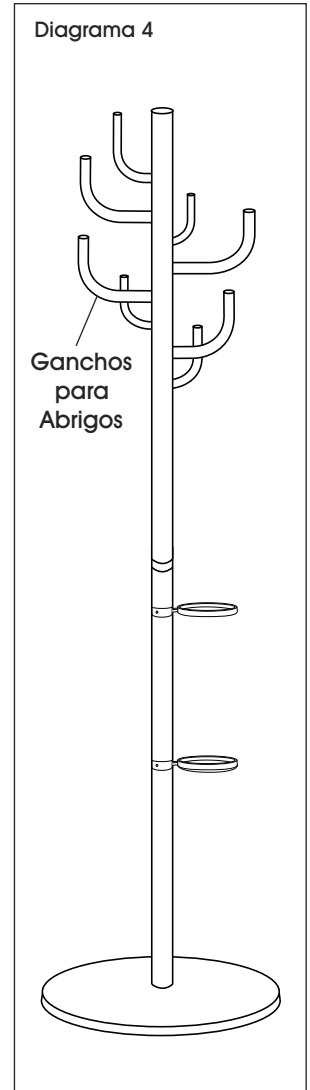

**ULINE**

800-295-5510  
uline.mx

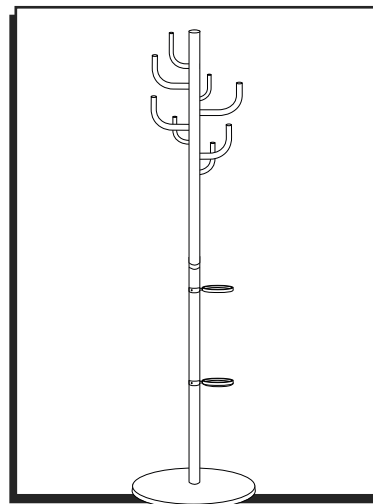

**OUTILS REQUIS**



Maillet en caoutchouc



Clé (inclus)

**PIÈCES**



Base x 1

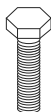

Boulon x 1

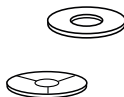

Plaque de raccordement x 2



Bague de raccordement x 1



Vis de raccordement x 1



Crochet à manteau x 8

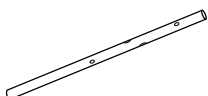

Montant vertical supérieur x 1

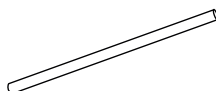

Montant vertical inférieur x 1



Anneau à parapluie x 2



Support à parapluie x 1

**MONTAGE**

1. Vissez la vis de raccordement sur le dessus du montant vertical inférieur. Fixez la bague de raccordement sur la vis de raccordement. Faites glisser le montant vertical supérieur dans la bague de raccordement pour le fixer au montant vertical inférieur. (Voir Figure 1)

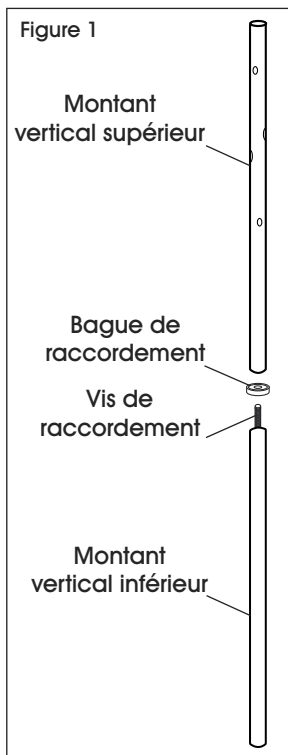

2. Placez le montant assemblé par-dessus une plaque de raccordement et positionnez-le sur le trou situé sur le dessus de la base. À l'aide du boulon, fixez la plaque de raccordement restante au bas de la base, en vous servant de la clé pour la serrer au montant vertical inférieur. (Voir Figure 2)

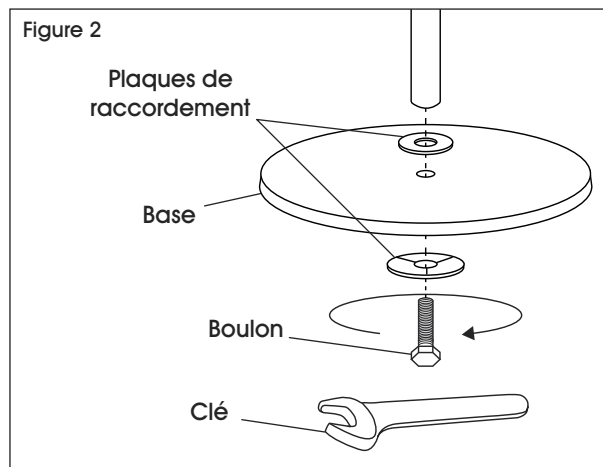

## MONTAGE SUITE

3. Faites glisser les anneaux à parapluie vers le bas des montants verticaux. Positionnez-les à la hauteur voulue. Placez le support à parapluie dans l'anneau inférieur. (Voir Figure 3)

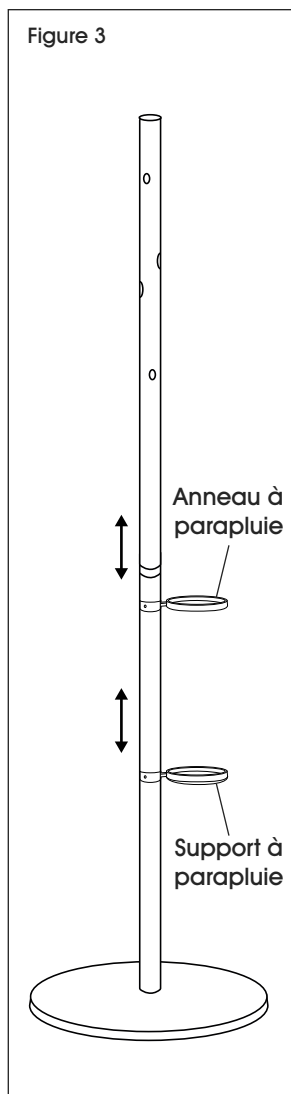

4. Utilisez un maillet pour installer les crochets à manteau et ainsi compléter le montage. (Voir Figure 4)

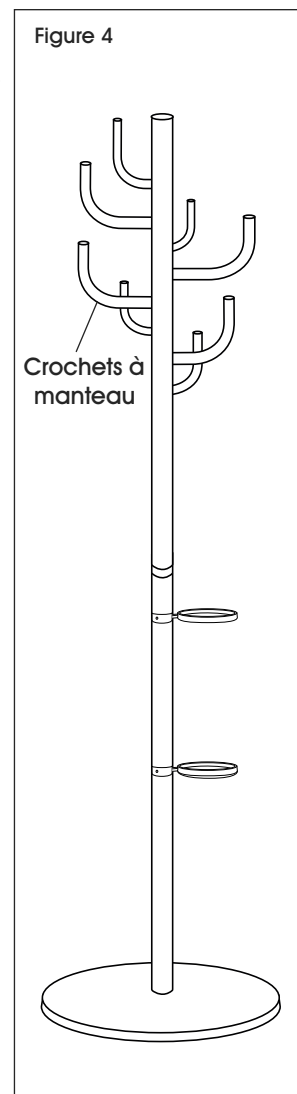

**ULINE**

1-800-295-5510

uline.ca