

**ULINE**

# WIRE SHELF BIN ORGANIZER

1-800-295-5510  
uline.com

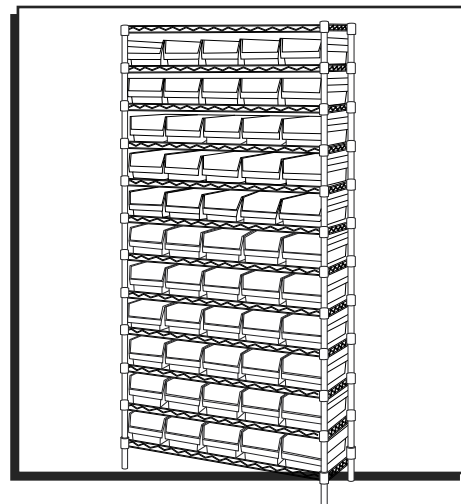

## PARTS

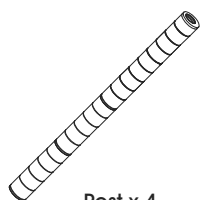

Post x 4

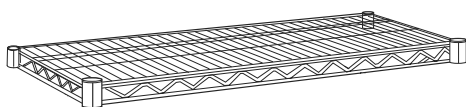

Shelf x 12



Shelf Support x 48 Sets



Self-Leveler x 4

## INSTALLATION OF SELF-LEVELERS AND OPTIONAL CASTERS

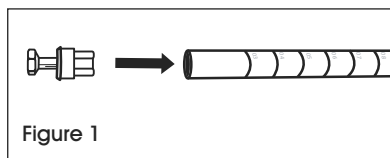

Figure 1

### TO INSTALL SELF-LEVELERS

 **NOTE:** If installing casters, do not install self-levelers.

1. Make sure post is positioned as shown. (See Figure 1)
2. Insert self-leveler into open end of post.
3. Tap on ground until self-leveler slides into post.
4. Repeat steps 2 and 3 for other posts.

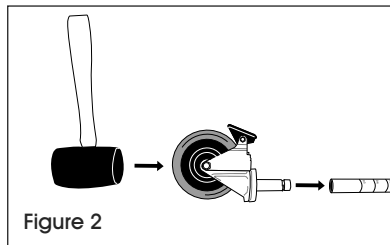

Figure 2

### TO INSTALL OPTIONAL CASTERS

1. Make sure post is positioned as shown. (See Figure 2)
2. Engage the wheel brakes to keep casters from rolling during assembly. Use a rubber mallet to tap caster stems into posts. (See Figure 2)

## INSTRUCTIONS FOR UNIT ASSEMBLY

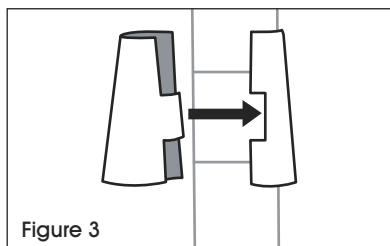
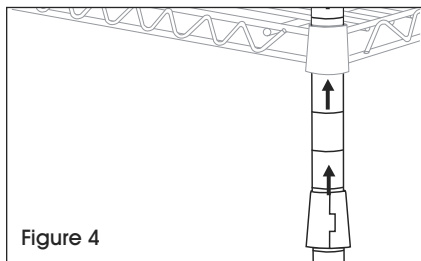

Figure 3

1. Start with the lowest shelf. Snap the interlocking pieces of a shelf support (wide end down) around the post at the lowest groove where shelf is to be located. Slide the support up or down until it snaps onto the groove. Add a shelf support to the same place on the remaining posts. (See Figure 3)

## INSTRUCTIONS FOR UNIT ASSEMBLY (CONTINUED)



2. Slide post through underside of shelf until shelf slides firmly over supports. (See Figure 4)

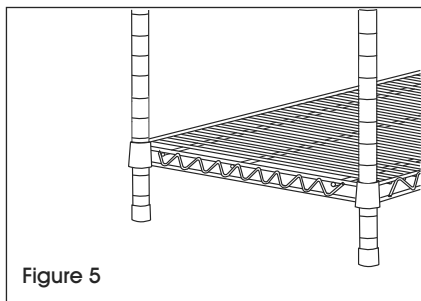

3. Stand unit upright. Gently tap shelf down to secure it. (See Figure 5)

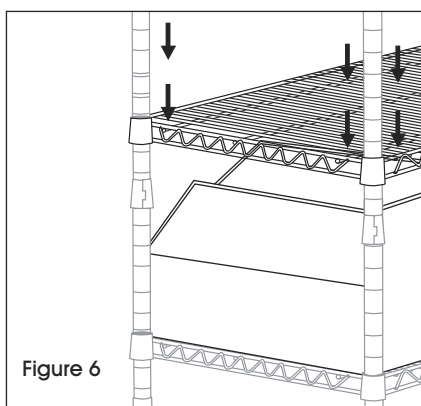

4. To determine the height of the next shelf, place a row of bins on the bottom shelf. Identify the groove that will allow the next shelf to fit right above the row of bins. Snap supports into this groove and then add and secure shelf. Repeat to add remaining shelves. (See Figure 6)



**NOTE:** Top shelf should be installed into the top groove of each post. Bins should not be placed on the top shelf.

**ULINE**

1-800-295-5510  
uline.com

**ULINE**

# ORGANIZADOR DE ALAMBRE CON REPISAS PARA GAVETAS

800-295-5510  
uline.mx

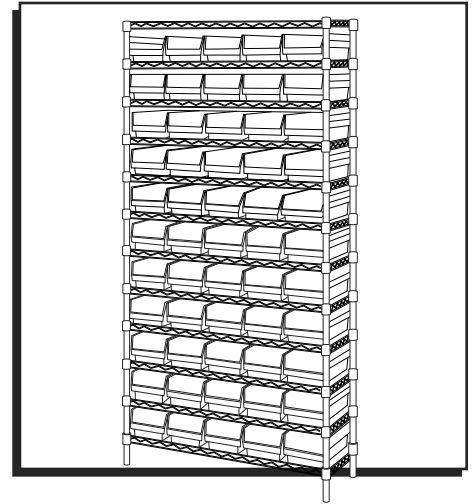

## PARTES

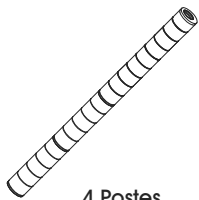

4 Postes

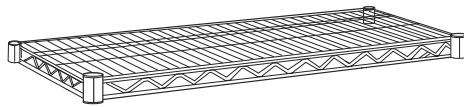

12 Repisas



48 Sets de Soportes  
para Repisa

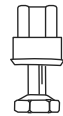

4 Autoniveladores

## INSTALACIÓN DE AUTONIVELADORES Y RUEDAS OPCIONALES



Diagrama 1

### INSTALAR AUTONIVELADORES

 **NOTA:** Si instala ruedas, no instale autoniveladores.

1. Asegúrese de que el poste esté posicionado como se muestra. (Vea Diagrama 1)
2. Inserte el autonivelador en el extremo abierto del poste.
3. Golpee en el piso hasta que el autonivelador se deslice dentro del poste.
4. Repita los pasos 2 y 3 para los otros postes.

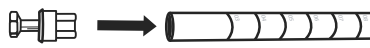

Diagrama 2

### INSTALAR RUEDAS OPCIONALES

1. Asegúrese de que el poste esté posicionado como se muestra. (Vea Diagrama 2)
2. Ponga los seguros de las ruedas para evitar que giren durante el ensamble. Utilice un mazo de caucho para insertar los vástagos de las ruedas en su lugar. (Vea Diagrama 2)

## INSTRUCCIONES PARA ENSAMBLE DE LA UNIDAD

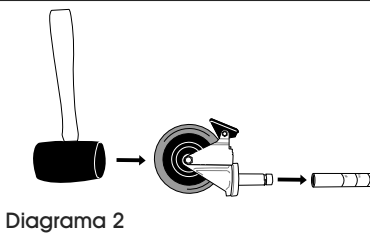

Diagrama 3

1. Comience con la repisa inferior. Embone las piezas interconectables de un soporte para repisa (con la parte ancha hacia abajo) alrededor del poste en la ranura más baja donde se ubicará la repisa. Deslice el soporte hacia arriba o abajo hasta que se trabe en la ranura. Agregue un soporte para repisa a la misma altura en los postes restantes. (Vea Diagrama 3)

## CONTINUACIÓN DE INSTRUCCIONES PARA ENSAMBLE DE LA UNIDAD

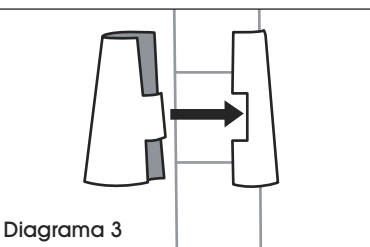
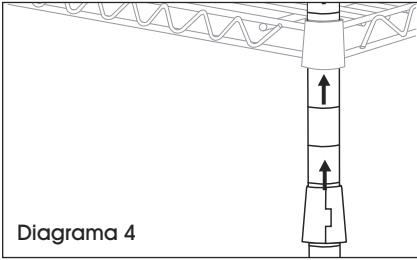

2. Deslice los postes a través de la parte inferior de la repisa hasta que la misma se deslice firmemente sobre los soportes. (Vea Diagrama 4)

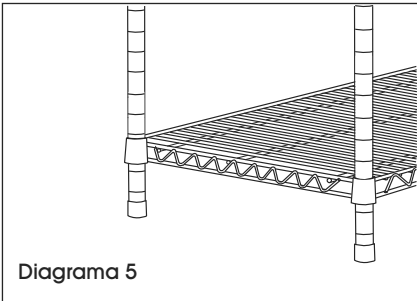

3. Coloque la unidad en posición vertical. Golpee ligeramente la repisa para asegurarla. (Vea Diagrama 5)

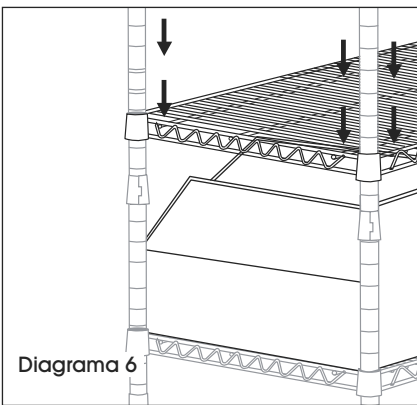

4. Para determinar el alto de la próxima repisa, coloque una fila de gavetas en la repisa inferior. Identifique la ranura que permitirá que la próxima repisa quepa directamente encima de la fila de gavetas. Encaje los soportes en esta ranura y luego agregue y asegure la repisa. Repita para añadir las repisas restantes. (Vea Diagrama 6)



**NOTA:** La repisa superior se debe instalar en la repisa superior de cada poste. Las gavetas no se deben colocar en la repisa superior.

**ULINE**

800-295-5510  
uline.mx

**ULINE**

# SUPPORT DE RANGEMENT POUR BACS À ÉTAGÈRES EN FIL DE MÉTAL

1-800-295-5510  
uline.ca

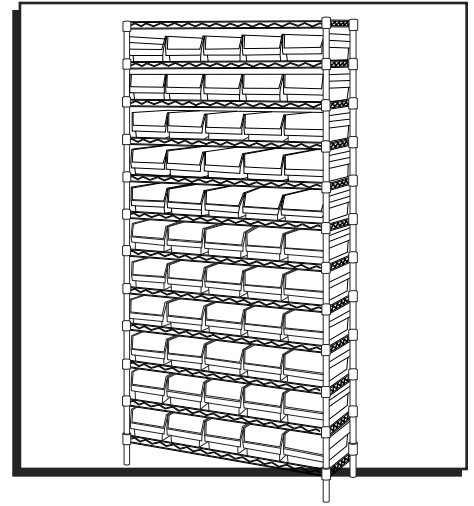

## PIÈCES

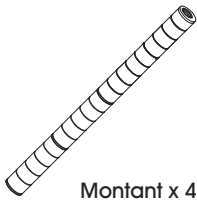

Montant x 4

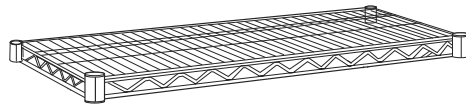

Tablette x 12



Support de tablette x 48 ensembles

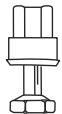

Pied autonivelant x 4

## INSTALLATION DES PIEDS AUTONIVELANTS ET DES ROULETTES OPTIONNELLES

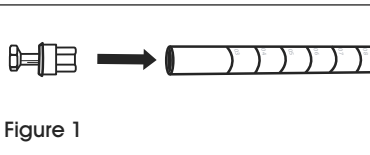

Figure 1

### POUR INSTALLER LES PIEDS AUTONIVELANTS



**REMARQUE :** Si vous installez des roulettes, n'installez pas les pieds autonivelants.

1. Assurez-vous que le montant est positionné comme illustré. (Voir Figure 1)
2. Insérez le pied autonivelant dans le bout ouvert du montant.
3. Tapotez le montant sur le sol jusqu'à ce que le pied autonivelant se glisse à l'intérieur.
4. Répétez les étapes 2 et 3 pour les autres montants.

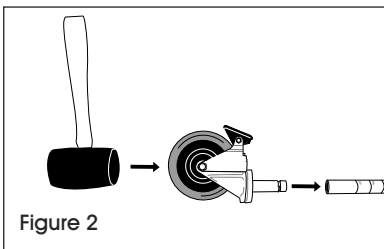

Figure 2

### POUR INSTALLER LES ROULETTES OPTIONNELLES

1. Assurez-vous que le montant est positionné comme illustré. (Voir Figure 2)
2. Actionnez le frein des roues pour empêcher le mouvement des roulettes lors du montage. Utilisez un maillet en caoutchouc pour tapoter la tige des roulettes dans les montants. (Voir Figure 2)

## INSTRUCTIONS DE MONTAGE DE L'UNITÉ

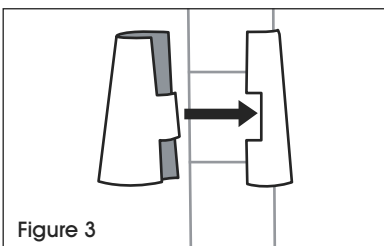
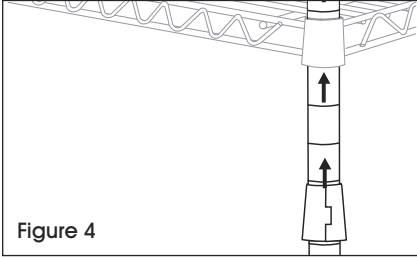

Figure 3

1. Commencez par la tablette la plus basse. Enclenchez les deux parties d'un support de tablette (la partie la plus large vers le bas) autour du montant à la rainure la plus basse où la tablette doit être placée. Glissez le support vers le haut ou vers le bas jusqu'à ce qu'il s'enclenche dans la rainure. Ajoutez un support de tablette au même endroit sur les montants restants. (Voir Figure 3)

## INSTRUCTIONS DE MONTAGE DE L'UNITÉ SUITE



2. Faites glisser le montant sous la partie inférieure de la tablette jusqu'à ce que la tablette se fixe fermement en place sur les supports. (Voir Figure 4)

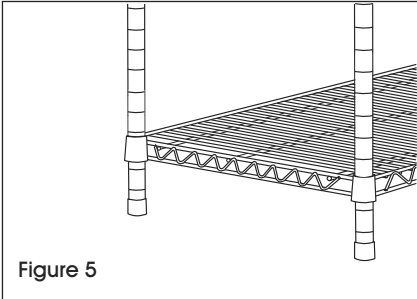

3. Placez l'unité à l'endroit. Tapotez doucement la tablette vers le bas pour la fixer. (Voir Figure 5)

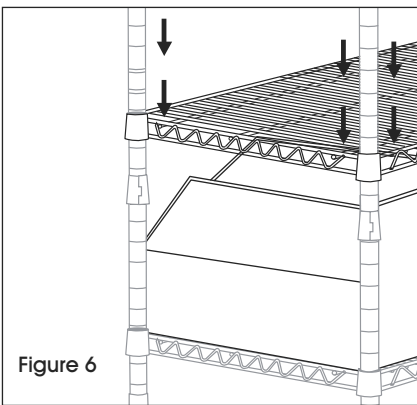

4. Pour déterminer la hauteur de la tablette suivante, placez une rangée de bacs sur la tablette inférieure. Identifiez la rainure permettant à la tablette suivante de reposer juste au dessus de la rangée de bacs. Enclenchez les supports au niveau de cette rainure, puis ajoutez et sécurisez la tablette. Répétez l'opération pour installer les tablettes restantes. (Voir Figure 6)



**REMARQUE :** Installez de préférence la tablette supérieure au niveau de la rainure supérieure de chaque montant. Ne placez pas de bacs sur la tablette supérieure.

**ULINE**

1-800-295-5510  
uline.ca