

ULINE H-9274

6-DRAWER ORGANIZER CART

1-800-295-5510
uline.com

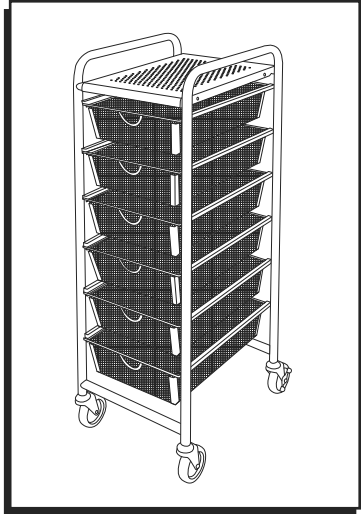

TOOLS INCLUDED



Allen Wrench



Wrench

PARTS

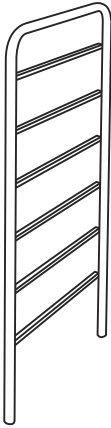

Side Frame x 2

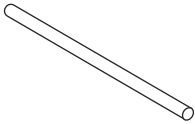

Connecting Bar x 4



Caster x 2



Locking Caster x 2

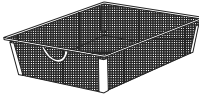

Drawer x 6



Screw x 8



Top Shelf x 1

ASSEMBLY

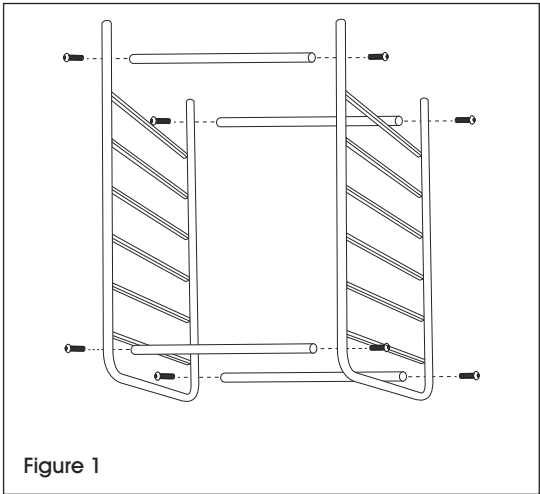

Figure 1

1. Insert screws through side frames and attach to connecting bars. (See Figure 1)

 **NOTE: Do not fully tighten screws.**

2. Place side frames upside down on a level surface with feet facing up. Tighten screws using Allen wrench. (See Figure 1)

ASSEMBLY CONTINUED

Figure 2

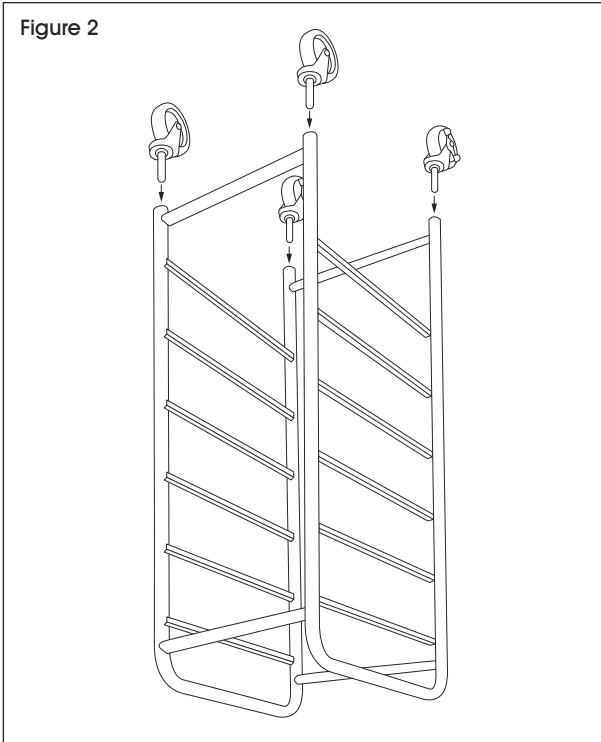

3. Insert casters into side frame tubing and tighten with wrench. (See Figure 2)

Figure 3

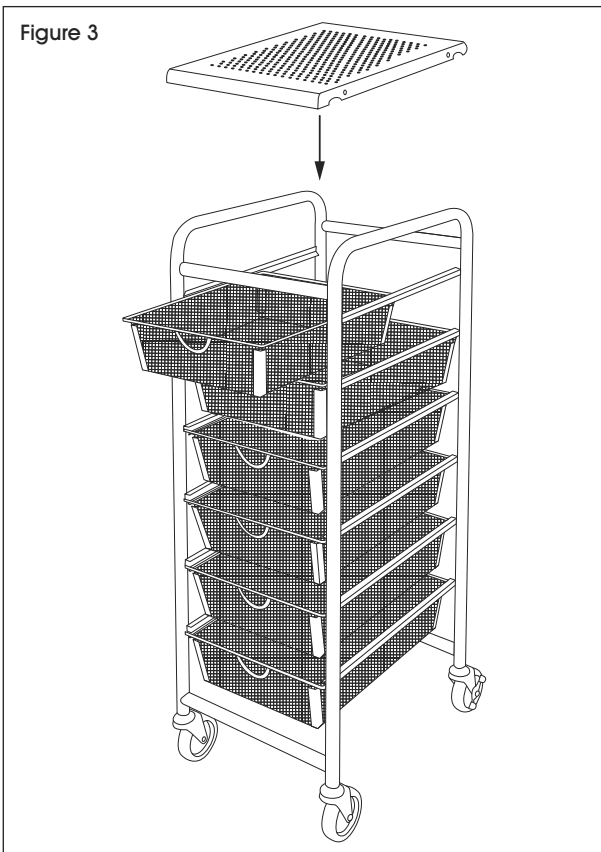

4. Flip cart right side up. Place top shelf across connecting bars and apply pressure to secure. (See Figure 3)
5. Insert drawers into rails on side frames. (See Figure 3)

ULINE

1-800-295-5510
uline.com

ULINE H-9274

CARRITO ORGANIZADOR DE 6 CAJONES

800-295-5510

uline.mx

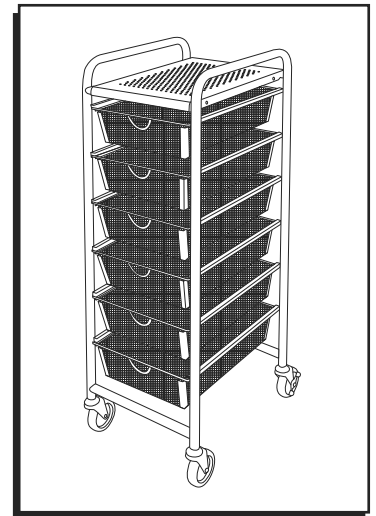

HERRAMIENTA INCLUIDA



Llave Allen



Llave

PARTES

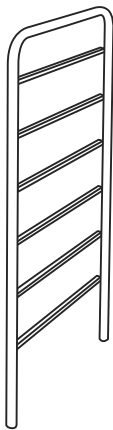

2 Armazones Laterales

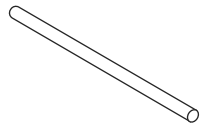

4 Barras de Conexión



2 Ruedas



2 Ruedas con Seguro

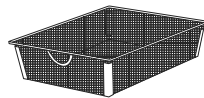

6 Cajones



8 Tornillos



1 Repisa Superior

ENSAMBLE



Diagrama 1

1. Inserte los tornillos en los armazones laterales y fije las barras de conexión. (Vea Diagrama 1)

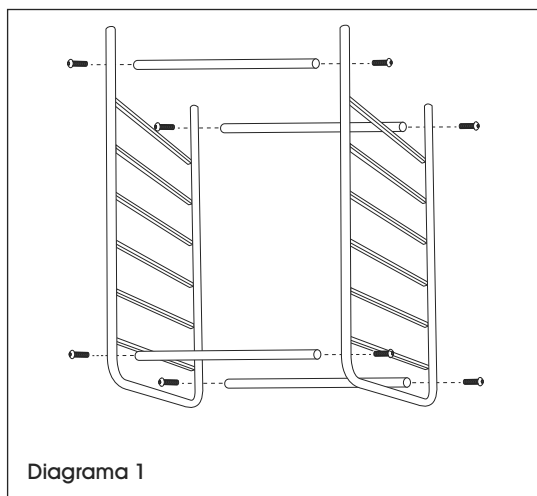

NOTA: No ajuste los tornillos por completo.

2. En una superficie nivelada, voltee los armazones laterales con las patas hacia arriba. Apriete los tornillos con la llave Allen. (Vea Diagrama 1)

CONTINUACIÓN DEL ENSAMBLE

Diagrama 2

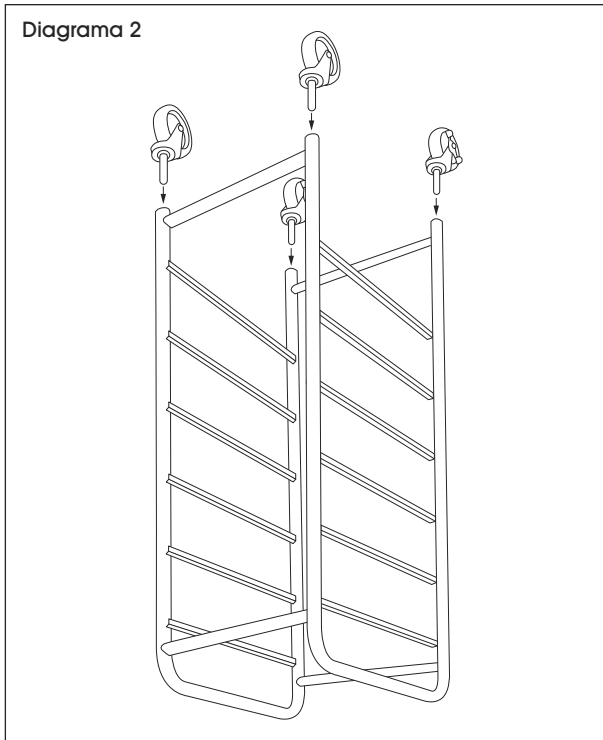

3. Inserte las ruedas en los tubos del armazón lateral y apriételas con la llave. (Vea Diagrama 2)

Diagrama 3

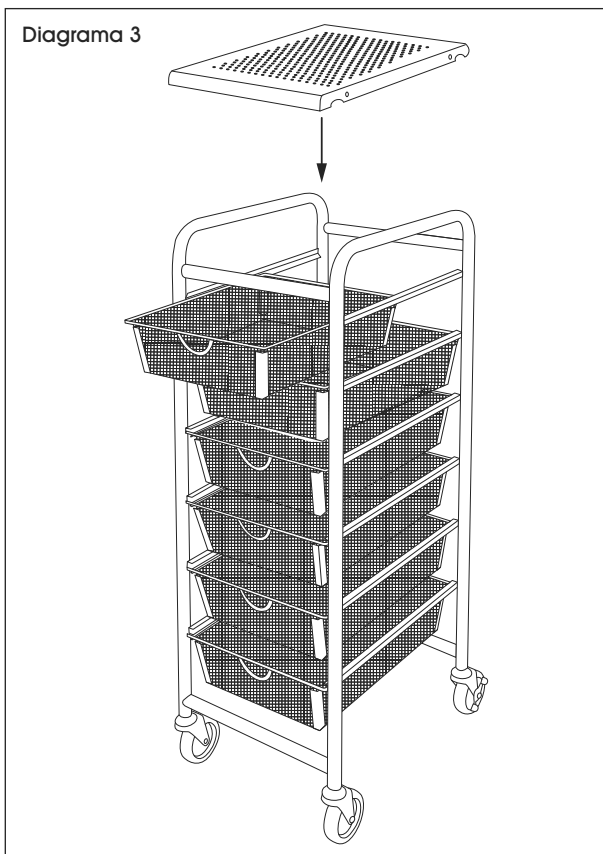

4. Voltee el carrito hacia arriba. Coloque la repisa superior en las barras de conexión y aplique presión para asegurarla. (Vea Diagrama 3)
5. Inserte los cajones en los rieles de los armazones laterales. (Vea Diagrama 3)

ULINE

800-295-5510
uline.mx

ULINE H-9274

CHARIOT DE RANGEMENT À 6 TIROIRS

1-800-295-5510

uline.ca

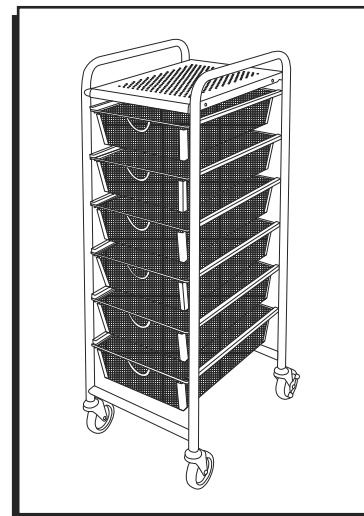

OUTILS INCLUS



Clé Allen



Clé

PIÈCES

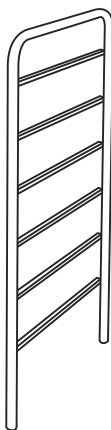

Cadre latéral x 2

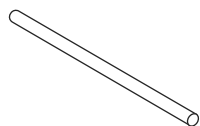

Barre de connexion x 4



Roulette x 2



Roulette blocable x 2

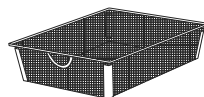

Tiroir x 6



Vis x 8

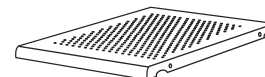

Tablette supérieure x 1

MONTAGE

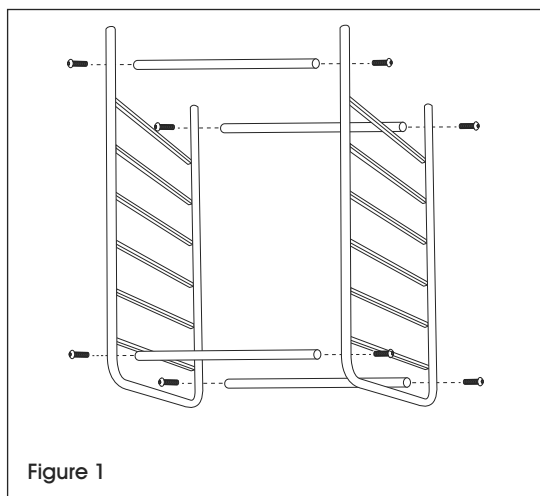

Figure 1

1. Insérez les vis dans les cadres latéraux et fixez-les aux barres de connexion. (Voir Figure 1)



REMARQUE : Ne serrez pas complètement les vis.

2. Posez les cadres latéraux à l'envers sur une surface plane, les pieds tournés vers le haut. Serrez les vis à l'aide de la clé Allen. (Voir Figure 1)

MONTAGE SUITE

Figure 2

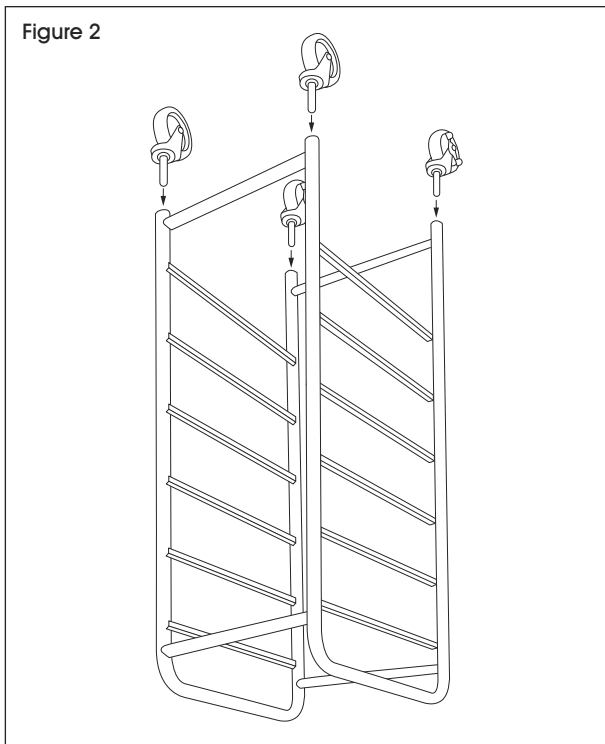

3. Insérez les roulettes dans les tubes du cadre latéral et serrez-les à l'aide de la clé fournie. (Voir Figure 2)

Figure 3

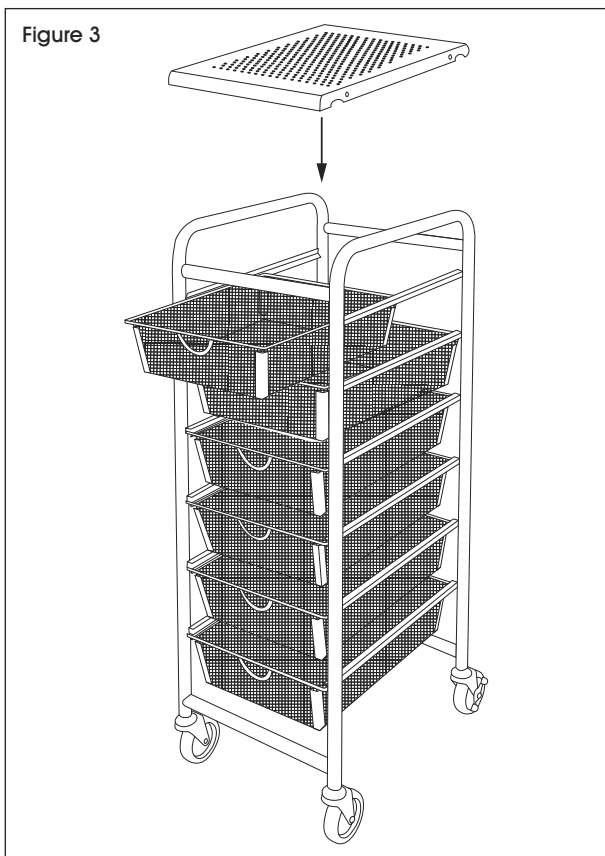

4. Retournez le chariot en position normale. Placez la tablette supérieure sur les barres de connexion et appliquez une pression pour la fixer en place. (Voir Figure 3)
5. Insérez les tiroirs en les glissant dans les rails des cadres latéraux. (Voir Figure 3)

ULINE

1-800-295-5510
uline.ca