

ULINE H-9854 WALL-MOUNTED COAT RACK

1-800-295-5510
uline.com

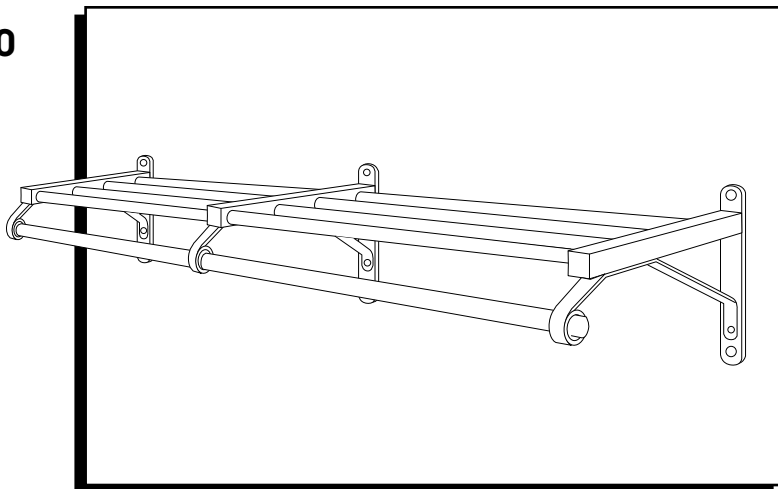

TOOL NEEDED



Phillips Screwdriver

PARTS

Contents of H-9854S Starter Box

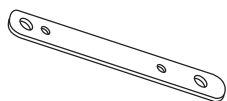

Back Strip (A) x 2

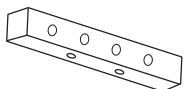

End Shelf Support (B,C) x 2

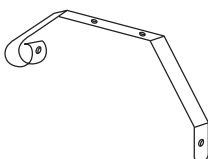

Shelf Support Brace (D) x 2

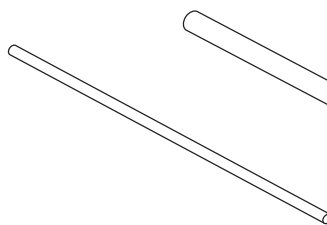

Shelf Tube (E) x 4

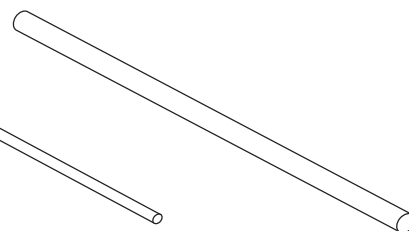

Hanger Bar (F) x 1



1/4 x 3/8" Round Head Screw (G) x 6



1/4 x 1" Flat Head Screw (H) x 2



10-24 x 3/8" Round Head Screw (I) x 2



10 x 2" Round Head Screw (J) x 4



Black End Cap (K) x 2

Contents of H-9854A Add-on Box

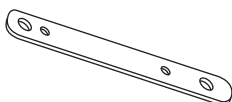

Back Strip (A) x 1

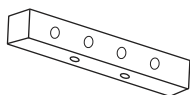

Center Shelf Support (L) x 1

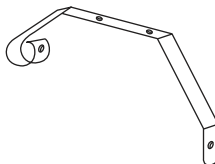

Shelf Support Brace (D) x 1

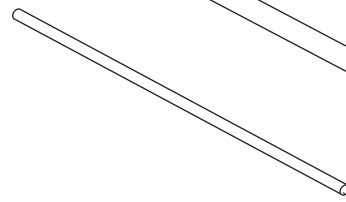

Shelf Tube
with Tapered End (M) x 4

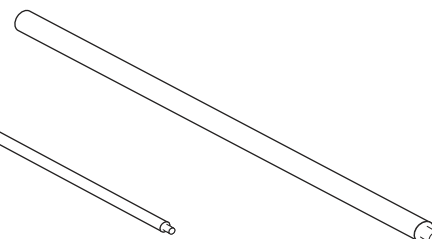

Hanger Bar (N) x 1



1/4 x 3/8" Round Head Screw (G) x 3



1/4 x 1" Flat Head Screw (H) x 1



10-24 x 3/8" Round Head Screw (I) x 1



10 x 2" Round Head Screw (J) x 2

ASSEMBLY

1. Open both H-9854S and H-9854A boxes and arrange parts on a flat surface. (See Figure 1)



NOTE: The large 3/4" diameter holes face to the right on the left end shelf support and to the left on the right end shelf support.

Figure 1

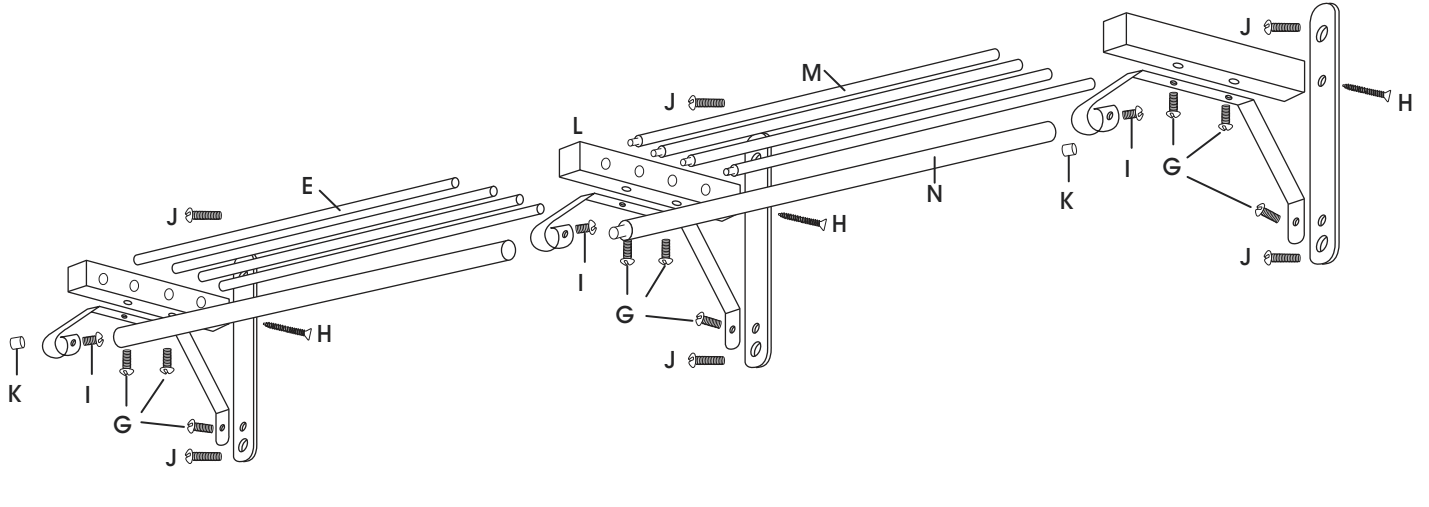

2. Assemble left, center and right brackets. Tighten H screws first and then G screws. (See Figures 2-4)

Figure 2

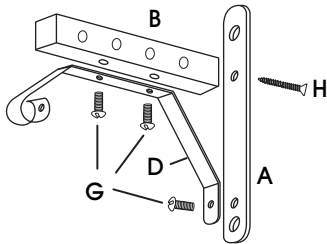

Left Bracket

Figure 4

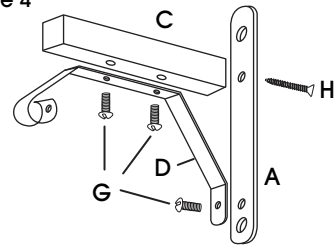

Right Bracket

Figure 3

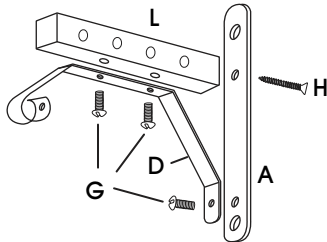

Center Bracket

ASSEMBLY CONTINUED

3. Mount the left bracket to the wall using two J screws, ensuring the large holes face to the right and the bracket is level.
4. Insert all E shelf tubes into the holes in the left bracket.
5. Feed the other end of the E shelf tubes through the holes in the center bracket.
6. Position the center bracket so it is as far right as possible while still supporting the E shelf tubes. Mount the center bracket to the wall using two J screws, ensuring the bracket is level.
7. Insert the tapered ends of M shelf tubes through the holes in the center bracket and into the ends of the E shelf tubes.
8. Insert the ends of the M shelf tubes into the holes on the right bracket.
9. Mount the right bracket to the wall using two J screws, ensuring the bracket is level.
10. Feed F hanger bar through left and center brackets.
11. Feed N hanger bar through the right and center brackets, ensuring the tapered end fits into the end of the F hanger bar.
12. Center the hanger bar between brackets and tighten into place with the three I screws.
13. Press one K black end cap into each end of the hanger bar.

ULINE

1-800-295-5510
uline.com

ULINE H-9854

RACK DE INSTALACIÓN EN PARED PARA ABRIGOS

800-295-5510
uline.mx

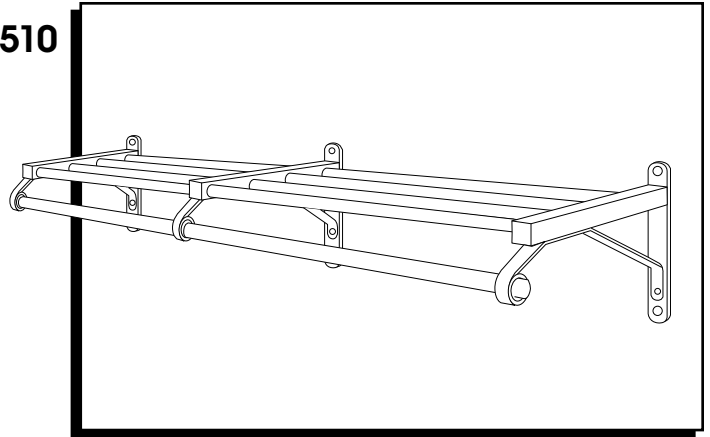

HERRAMIENTA NECESARIA

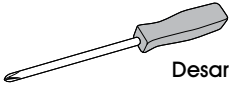

Desarmador de Cruz

PARTES

Contenido de la Caja para Instalación Básica del H-9854S

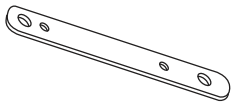

2 Tiras Posteriores (A)

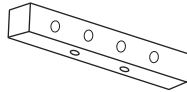

2 Soportes para Repisa de Extremo (B y C)

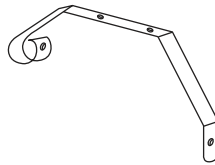

2 Soportes para Repisa (D)

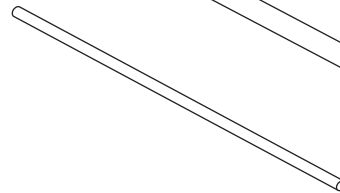

4 Tubos para Repisa (E)

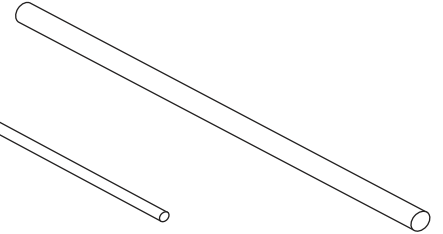

1 Barra para Colgar (F)



6 Tornillos de Cabeza Redonda de 1/4 x 3/8" (G)



2 Tornillos de Cabeza Plana de 1/4 x 1" (H)



2 Tornillos de Cabeza Redonda de 10-24 x 3/8" (I)



4 Tornillos de Cabeza Redonda 10 x 2" (J)



2 Tapas de Extremo Negras (K)

Contenido de la Caja para Instalación Complementaria del H-9854A

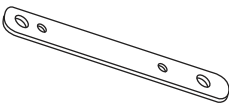

1 Tira Posterior (A)

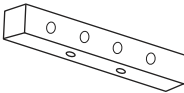

1 Soporte para Repisa Central (L)

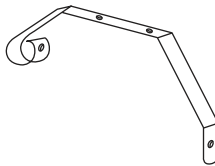

1 Soporte para Repisa (D)

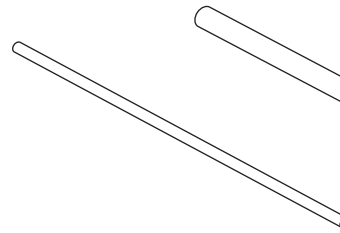

4 Tubos para Repisa (M) con Punta Cónica

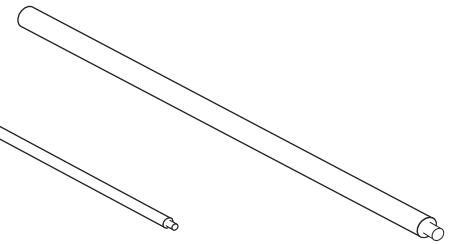

1 Barra para Colgar (N)



3 Tornillos de Cabeza Redonda de 1/4 x 3/8" (G)



1 Tornillo de Cabeza Plana de 1/4 x 1" (H)



1 Tornillo de Cabeza Redonda de 10-24 x 3/8" (I)



2 Tornillos de Cabeza Redonda de 10 x 2" (J)

ENSAMBLE

1. Abra las dos cajas H-9854S y H-9854A y ordene las partes en una superficie plana. (Vea Diagrama 1)



NOTA: Los orificios grandes con un diámetro de 1.9 cm (3/4") miran hacia la derecha en el soporte para repisa de extremo izquierdo y hacia la izquierda en el soporte para repisa de extremo derecho.

Diagrama 1

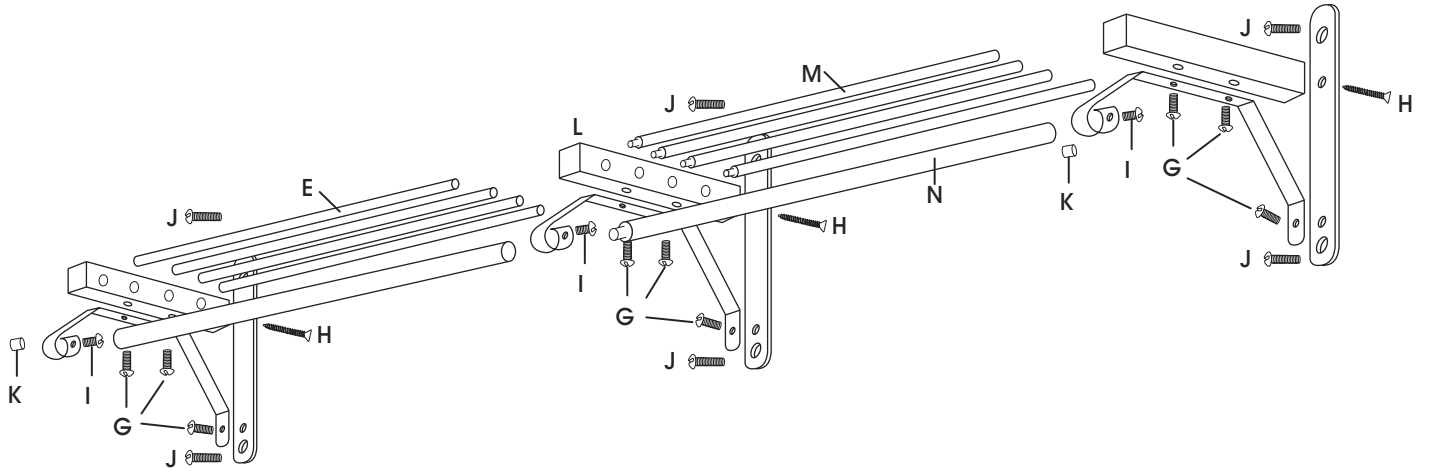

2. Ensamble los soportes izquierdo, central y derecho. Apriete primero los tornillos H y luego los tornillos G. (Vea Diagramas 2-4)

Diagrama 2

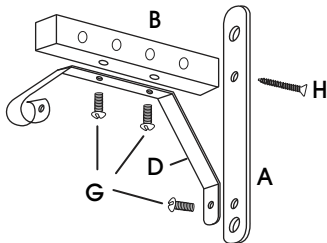

Soporte Izquierdo

Diagrama 4

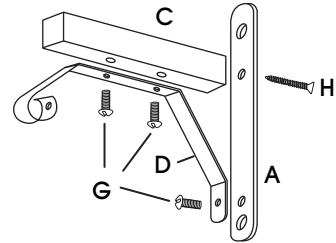

Soporte Derecho

Diagrama 3

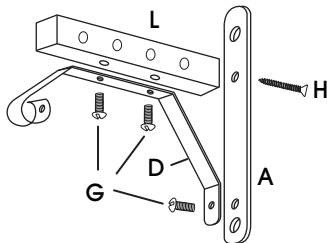

Soporte Central

CONTINUACIÓN DE ENSAMBLE

3. Fije el soporte izquierdo a la pared usando dos tornillos J, asegurándose de que los orificios grandes miren hacia la derecha y de que el soporte esté nivelado.
4. Inserte todos los tubos para repisa en los orificios en el soporte izquierdo.
5. Inserte el otro extremo de los tubos para repisa E a través de los orificios del soporte central.
6. Coloque el soporte central de forma que quede lo más a la derecha posible soportando a la vez los tubos para repisa E. Fije el soporte central a la pared usando dos tornillos J, asegurándose de que el soporte esté nivelado.
7. Inserte las puntas cónicas de los tubos para repisa M a través de los orificios del soporte central y en los extremos de los tubos para repisa E.
8. Inserte los extremos de los tubos para repisa M en los orificios del soporte derecho.
9. Fije el soporte derecho a la pared usando dos tornillos J, asegurándose de que el soporte esté nivelado.
10. Inserte la barra para colgar F a través de los soportes izquierdo y central.
11. Inserte la barra para colgar N a través de los soportes derecho y central, asegurándose de que la punta cónica encaje en el extremo de la barra para colgar F.
12. Centre la barra para colgar entre los soportes y apriétela para fijarla en su lugar con tres tornillos I.
13. Inserte una tapa de extremo negra K ejerciendo presión en cada uno de los extremos de la barra para colgar.

ULINE

800-295-5510

uline.mx

ULINE H-9854

PORTEMANTEAU À FIXATION MURALE

1 800 295-5510
uline.ca

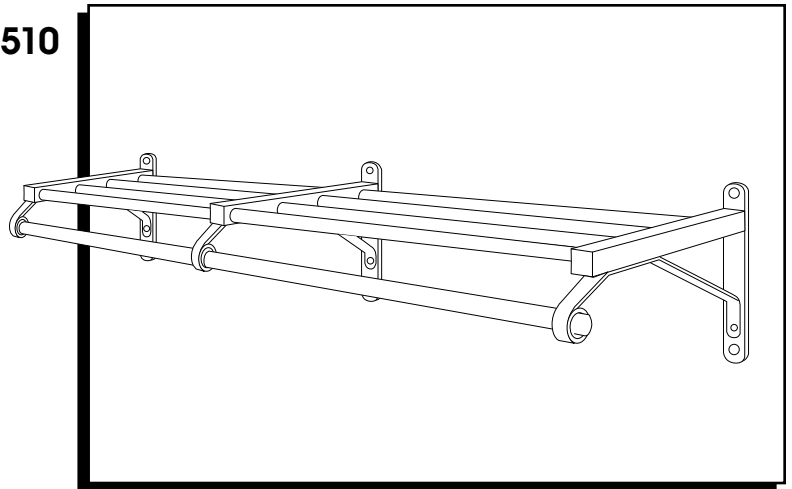

OUTIL REQUIS



PIÈCES

Contenu de la boîte de base H-9854S

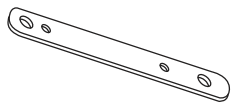

Bande arrière (A) x 2

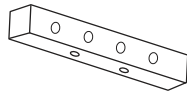

Support d'extrémité de
tablette (B et C) x 2

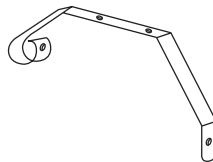

Renfort de soutien de
tablette (D) x 2

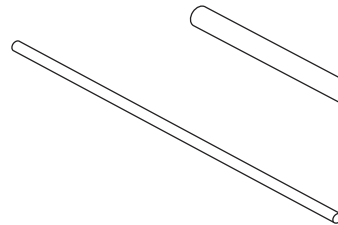

Tube de tablette (E) x 4

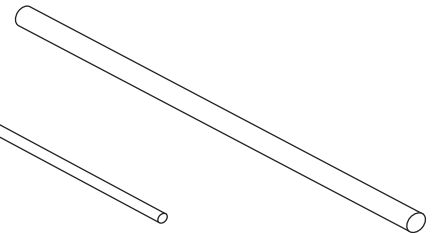

Tringle (F) x 1



Vis à tête ronde de 1/4 x 3/8 po (G) x 6



Vis à tête plate de 1/4 x 1 po (H) x 2



Vis à tête ronde de 10-24 x 3/8 po (I) x 2



Vis à tête ronde de 10 x 2 po (J) x 4



Capuchons d'extrémité noirs (K) x 2

Contenu de la boîte supplémentaire H-9854A

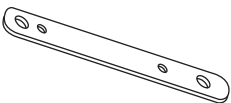

Bande arrière (A) x 1

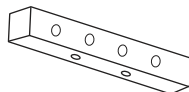

Support de tablette du
milieu (L) x 1

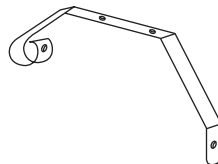

Renfort de soutien de
tablette (D) x 1

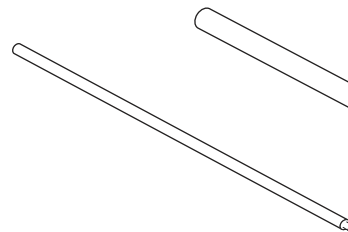

Tube de tablette (M) x 4
à extrémité effilée

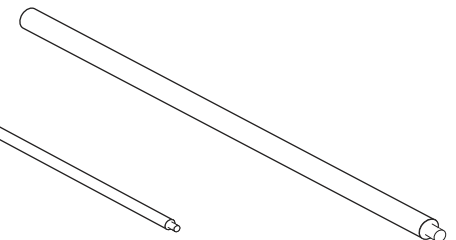

Tringle (N) x 1



Vis à tête ronde de 1/4 x 3/8 po (G) x 3



Vis à tête plate de 1/4 x 1 po (H) x 1



Vis à tête ronde de 10-24 x 3/8 po (I) x 1



Vis à tête ronde de 10 x 2 po (J) x 1

ASSEMBLAGE

1. Ouvrez les boîtes H-9854S et H-9854A et disposez les pièces sur une surface plane. (Voir Figure 1)



REMARQUE : Les grands trous de 1,9 cm (3/4 po) de diamètre sont orientés vers la droite sur le support d'extrémité gauche de tablette et vers la gauche sur le support d'extrémité droit de tablette.

Figure 1

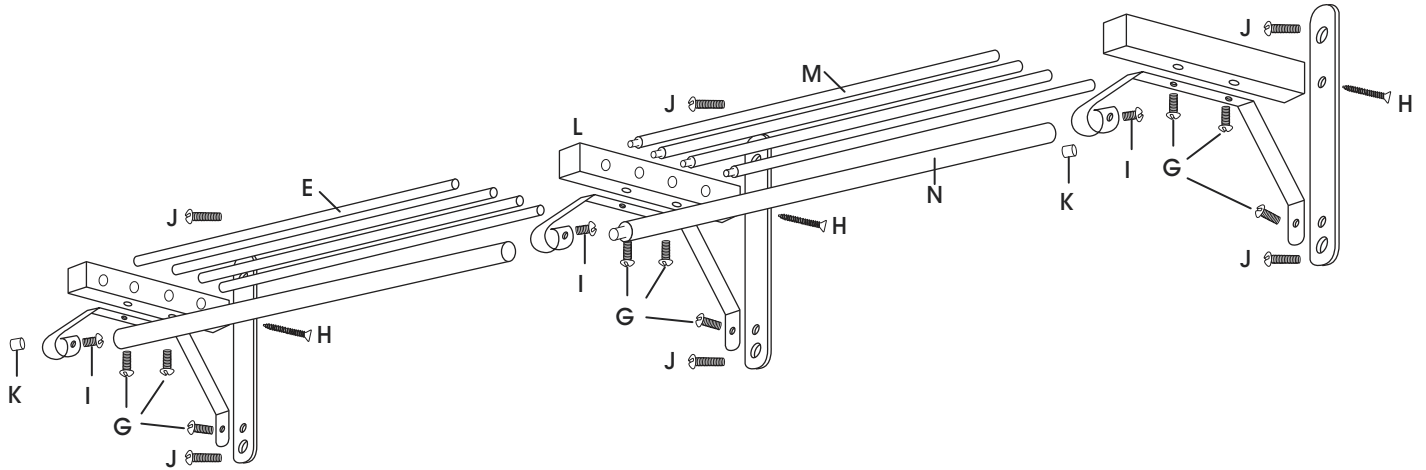

2. Assemblez les supports de gauche, du milieu et de droite. Serrez d'abord les vis H, puis les vis G. (Voir Figures 2 à 4)

Figure 2

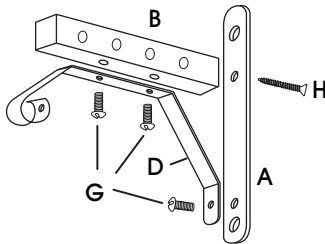

Support de gauche

Figure 4

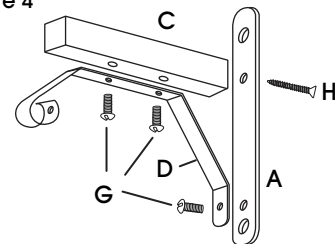

Support de droite

Figure 3

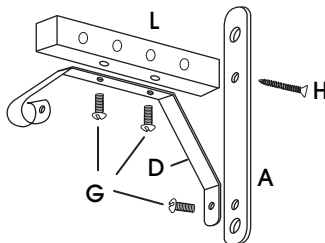

Support du milieu

ASSEMBLAGE SUITE

- Fixez le support de gauche au mur à l'aide de deux vis J en vous assurant que les grands trous sont orientés vers la droite et que le support est de niveau.
- Insérez tous les tubes de tablette E dans les trous du support de gauche.
- Faites passer l'autre extrémité des tubes de tablette E dans les trous du support du milieu.
- Positionnez le support du milieu de façon à ce qu'il soit le plus à droite possible tout en soutenant les tubes de tablette E. Fixez le support du milieu au mur à l'aide de deux vis J en vous assurant que le support est de niveau.
- Insérez les extrémités effilées des tubes de tablette M dans les trous du support du milieu et dans les extrémités des tubes de tablette E.
- Insérez les extrémités effilées des tubes de tablette M dans les trous du support de droite.
- Fixez le support de droite au mur à l'aide de deux vis J en vous assurant que le support est de niveau.
- Faites passer la tringle F dans les supports de gauche et du milieu.
- Faites passer la tringle N dans les supports de droite et du milieu en vous assurant que l'extrémité effilée s'insère dans l'extrémité de la tringle F.
- Centrez la tringle entre les supports et serrez en position à l'aide des trois vis I.
- Insérez un capuchon d'extrémité noir dans chaque extrémité de la tringle.

