

# ULINE H-9920 PURELL® JUMBO WIPES WALL DISPENSER

1-800-295-5510  
uline.com

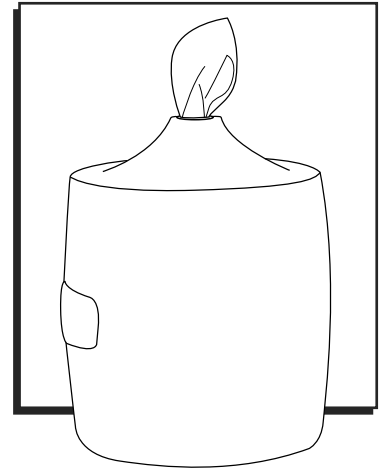

## TOOLS NEEDED



Drill



Drill Bit

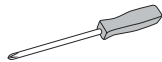

Phillips Screwdriver

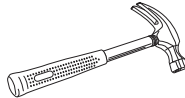

Hammer



Level

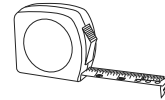

Tape Measure

## PARTS

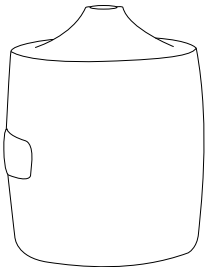

Dispenser x 1



Key x 1

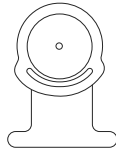

Nozzle x 1



Wall Anchor x 4

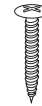

Screw x 4



Threading Tool x 1

## MOUNTING

 **NOTE:** Recommended mounting height is 45" from floor to top of dispenser.

 **NOTE:** Ensure proper mounting hardware is used for appropriate wall composition as enclosed hardware may not be compatible with wall surface.

1. Insert key into lock on side of dispenser and turn clockwise to open cover. (See Figure 1)

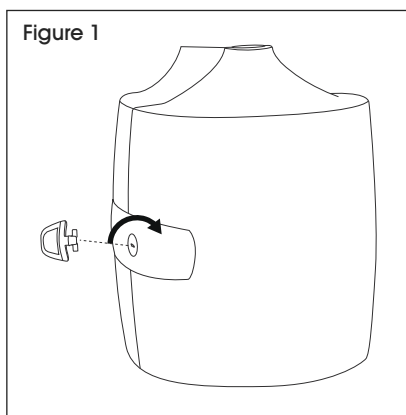

2. Open dispenser cover and hold dispenser to ideal mounting place on wall. (See Figure 2)

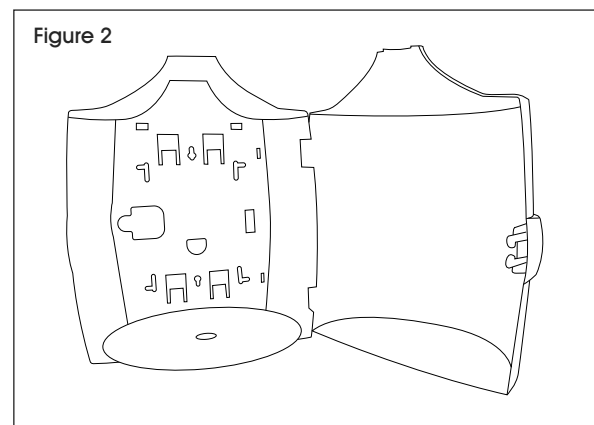

## MOUNTING CONTINUED

3. Mark the four holes on the wall where screws will be inserted. (See Figure 3)

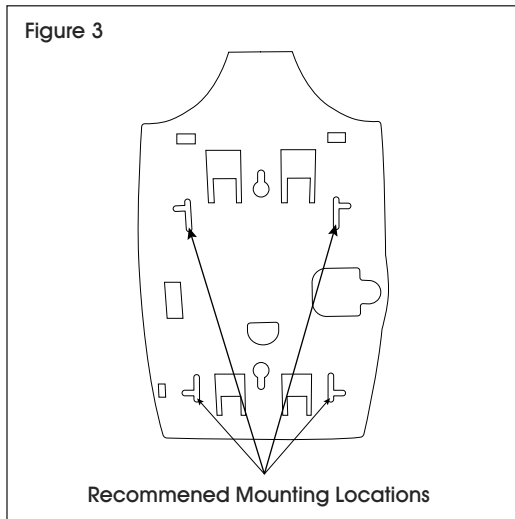

5. Hold dispenser over previously drilled holes and insert screws.
6. Insert nozzle with key toward back of dispenser. Slide in with "patent pending" facing down. (See Figure 5)

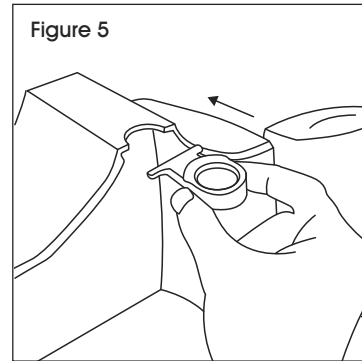

4. Drill into wall at four marked locations with an appropriate drill bit. (See Figure 4) Insert wall anchors if necessary.

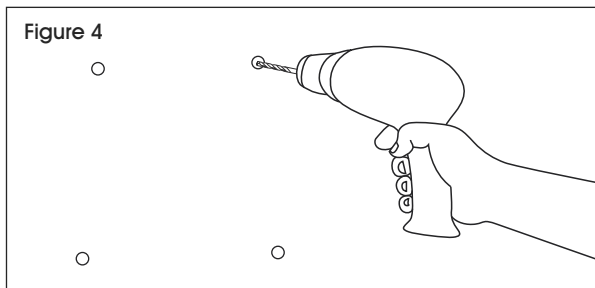

## LOADING WIPES

1. Insert key and turn clockwise to open dispenser. (See Figure 6)

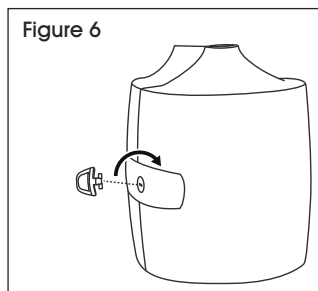

2. Locate tear-notch on side of wipe pouch. (See Figure 7)

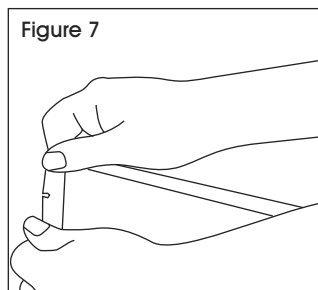

3. Tear straight across to open. Do not remove wipe roll from pouch. (See Figure 8)

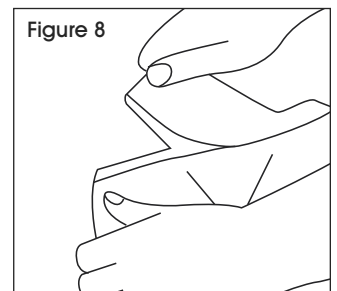

4. Pull first wipe from center of roll up through opening in pouch. (See Figure 9)

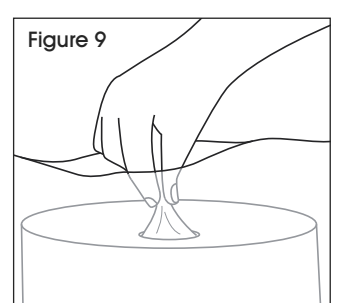

## LOADING WIPES CONTINUED

5. Place wipe pouch into dispenser.
6. Thread first wipe through dispensing nozzle in top of wall-mounted dispenser using threading tool. (See Figure 10)
7. Close cover.

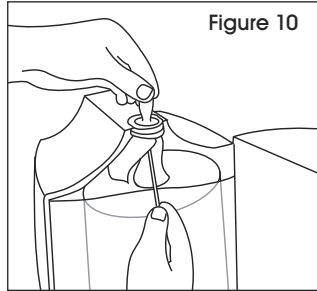

**ULINE**

1-800-295-5510  
uline.com

**ULINE H-9920**

# PURELL® DESPACHADOR DE PARED DE TOALLITAS DESINFECTANTES JUMBO

800-295-5510

uline.mx

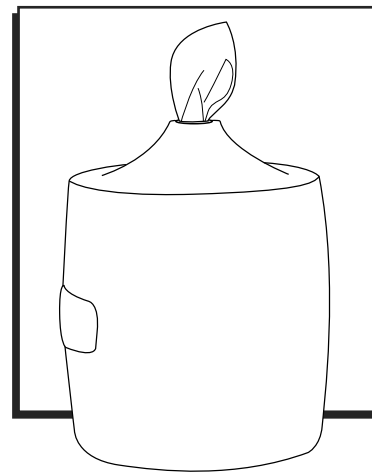

## HERRAMIENTAS NECESARIAS

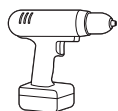

Taladro



Broca

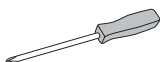

Desarmador de Cruz

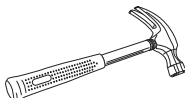

Martillo

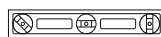

Nivel

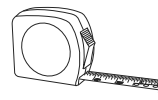

Cinta de Medir

## PARTES

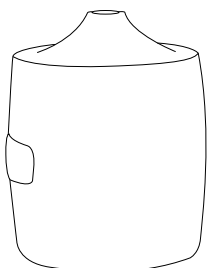

1 Despachador



1 Llave

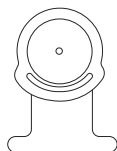

1 Boquilla



4 Taquetes

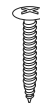

4 Tornillos



1 Herramienta de Rosca

## INSTALACIÓN



**NOTA:** La altura de instalación recomendada es de 1.14 m (45") del piso hasta la parte superior del despachador.



**NOTA:** Asegúrese de utilizar la tornillería de instalación adecuada para el tipo de pared en la que se realizará la instalación ya que la tornillería incluida podría no ser compatible con la superficie de la pared.

1. Inserte la llave en la cerradura de la parte lateral del despachador y gírela en el sentido de las manecillas del reloj para abrir la cubierta. (Vea Diagrama 1)

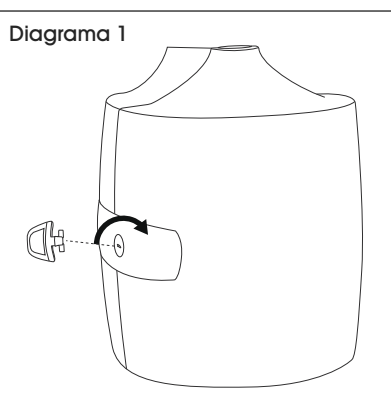

2. Abra la cubierta del despachador y sosténgalo contra el lugar ideal para instalarlo en la pared. (Vea Diagrama 2)

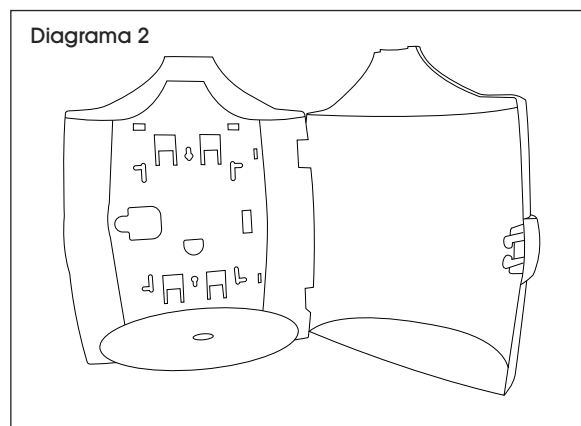

## CONTINUACIÓN DE INSTALACIÓN

3. Marque los cuatro orificios en la pared donde se insertarán los tornillos. (Vea Diagrama 3)

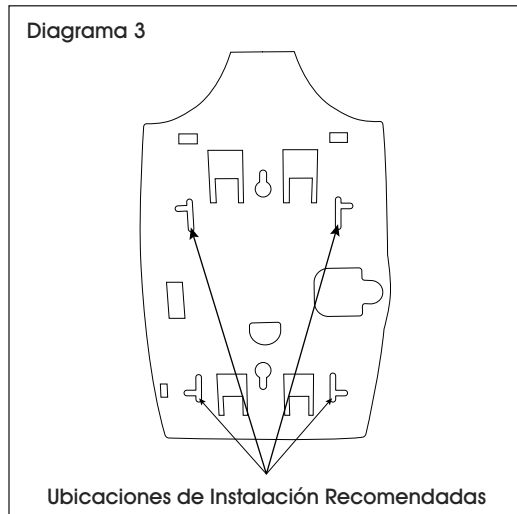

5. Sostenga el despachador sobre los orificios previamente perforados e inserte los tornillos.
6. Inserte la boquilla con la llave hacia la parte posterior del despachador. Deslícela hacia adentro con "patent pending" hacia abajo. (Vea Diagrama 5)

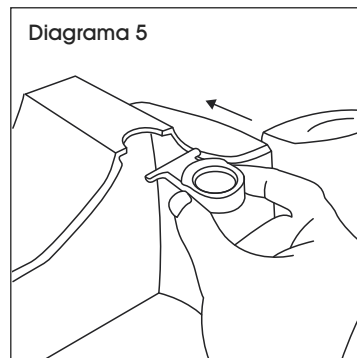

4. Con una broca adecuada, perfore en la pared las cuatro ubicaciones marcadas. (Vea Diagrama 4) Inserte los taquetes si es necesario.

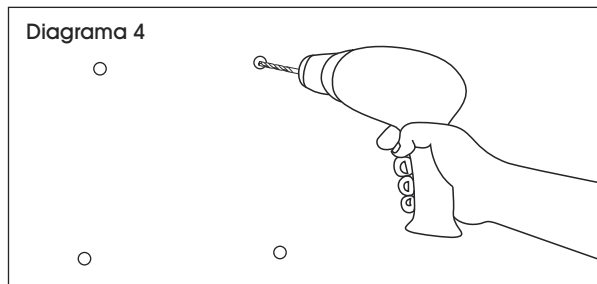

## CARGAR LAS TOALLITAS

1. Inserte la llave y gírela en el sentido de las manecillas del reloj para abrir el despachador. (Vea Diagrama 6)

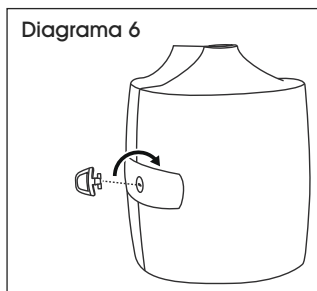

2. Localice la muesca en forma de lágrima en el lateral de la bolsa de toallitas. (Vea Diagrama 7)

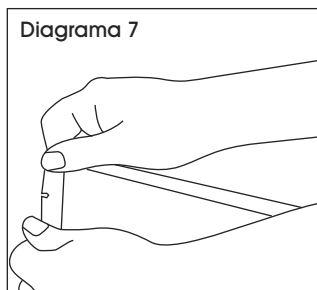

3. Rompa transversalmente para abrirla. No retire el rollo de toallitas de la bolsa. (Vea Diagrama 8)

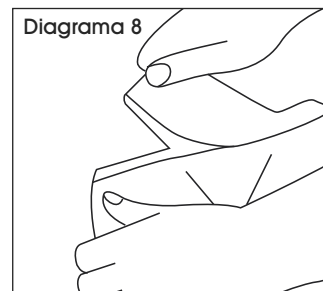

4. Jale la primera toallita del centro del rollo hacia arriba a través de la abertura de la bolsa. (Vea Diagrama 9)

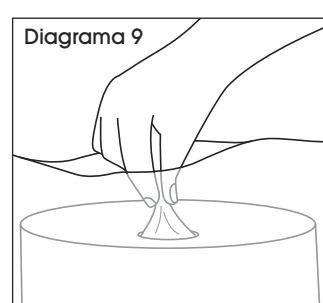

## CONTINUACIÓN DE CARGAR LAS TOALLITAS

5. Coloque la bolsa de toallitas en el despachador.
6. Pase la primera toallita a través de la boquilla encima del despachador de pared usando la herramienta de rosca. (Vea Diagrama 10)
7. Cierre la cubierta.

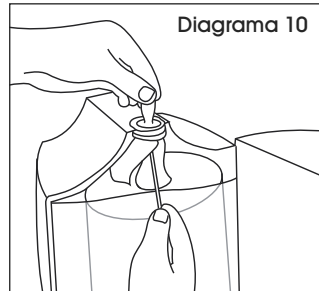

**ULINE**

800-295-5510  
uline.mx

**ULINE** H-9920

# PURELL<sup>MD</sup> – DISTRIBUTEUR DE LINGETTES FORMAT GÉANT – FIXATION MURALE

1-800-295-5510

uline.ca

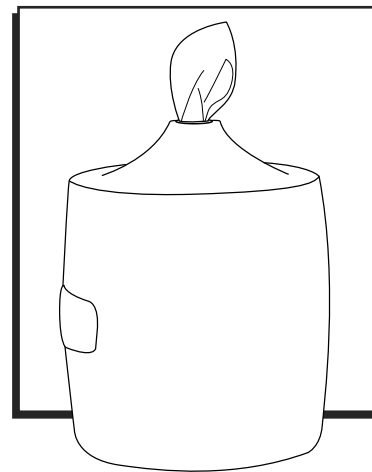

## OUTILS REQUIS



Perceuse



Mèche de perceuse

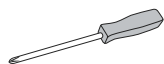

Tournevis cruciforme

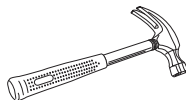

Marteau



Niveau

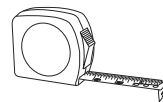

Ruban à mesurer

## PIÈCES

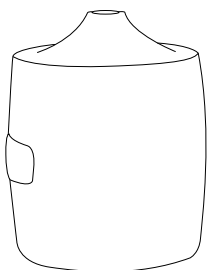

Distributeur x 1



Clé x 1

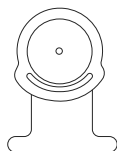

Buse x 1



Ancrage mural x 4



Vis x 4



Outil pour filetage x 1

## INSTALLATION



**REMARQUE :** La hauteur de pose recommandée est de 45 po allant du sol jusqu'au haut du distributeur.



**REMARQUE :** Assurez-vous que le matériel d'installation utilisé convienne à la composition du mur car il se peut que celui compris avec l'unité ne soit pas compatible avec la surface du mur.

1. Insérez la clé dans la serrure située sur le côté du distributeur et tournez-la dans le sens horaire pour ouvrir le couvercle. (Voir Figure 1)

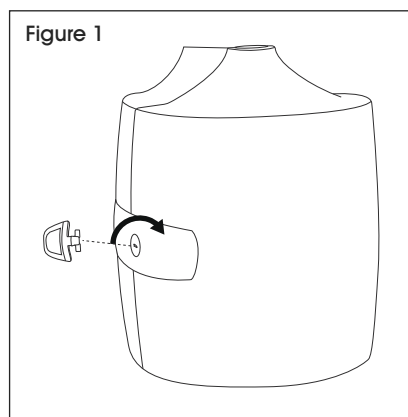

2. Ouvrez le couvercle et mettez le distributeur en position contre le mur à l'emplacement de montage idéal. (Voir Figure 2)

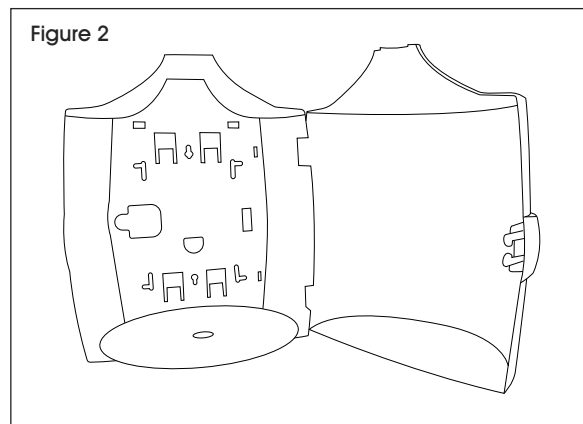

## INSTALLATION SUITE

3. Marquez les quatre trous sur le mur où les vis seront insérées. (Voir Figure 3)

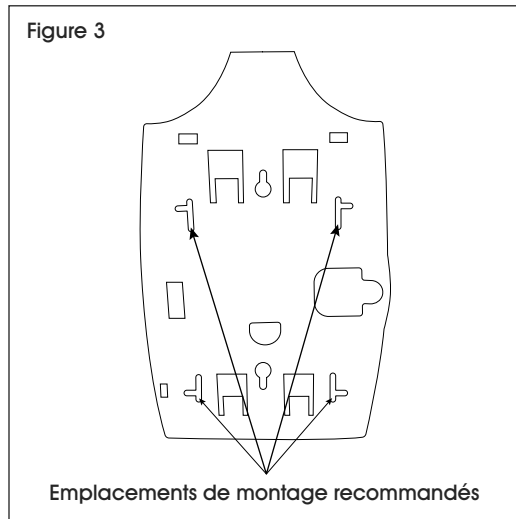

4. Percez le mur aux quatre endroits marqués avec une mèche de perceuse appropriée. (Voir Figure 4) Insérez les ancrages muraux si nécessaire.

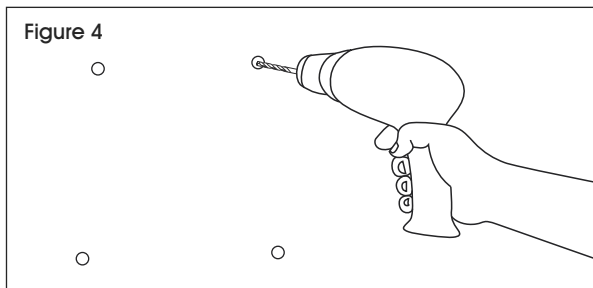

5. Positionnez le distributeur pour qu'il s'aligne sur les trous de montage prépercés et insérez les vis.
6. Lorsque le distributeur est positionné de sorte que la clé est à l'arrière du distributeur, insérez la buse. Lorsque vous faites glisser la buse en place, la mention « patent pending » doit faire face vers le bas. (Voir Figure 5)

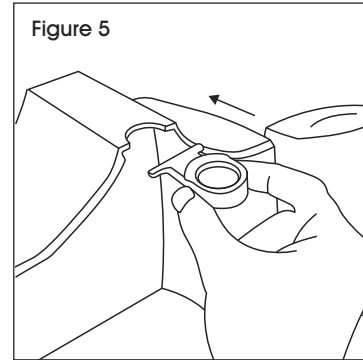

## CHARGEMENT DES LINGETES

1. Insérez la clé et tournez-la dans le sens horaire pour ouvrir le distributeur. (Voir Figure 6)

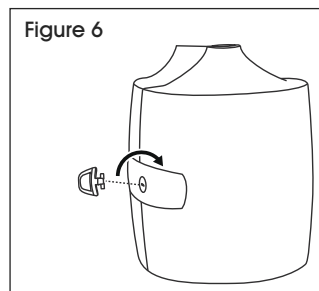

2. Repérez l'encoche de déchirure sur le côté de l'emballage de lingettes. (Voir Figure 7)

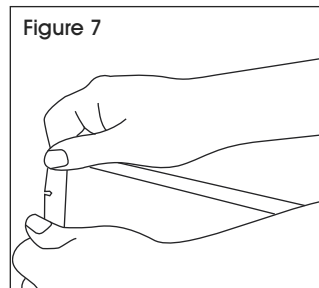

3. Déchirez en ligne droite pour ouvrir l'emballage. Ne retirez pas le rouleau de lingettes de l'emballage. (Voir Figure 8)

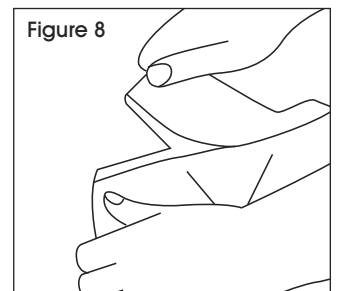

4. Tirez la première lingette du centre du rouleau par l'entremise de l'ouverture de l'emballage. (Voir Figure 9)

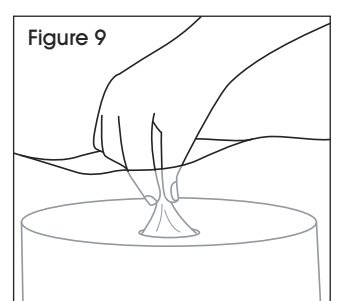



## CHARGEMENT DES LINGETTES SUITE

5. Déposez l'emballage de lingettes dans le distributeur.
6. Faites passer la première lingette dans la buse de distribution située au haut du distributeur à pose murale. (Voir Figure 10)
7. Fermez le couvercle.

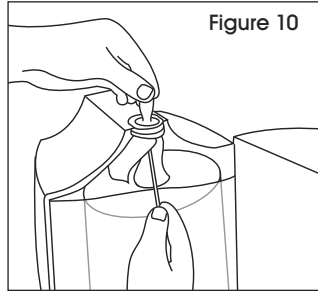

**ULINE**

1-800-295-5510  
uline.ca