

ULINE H-992 MONARCH 1136[®] TWO LINE LABEL GUN

1-800-295-5510
uline.com

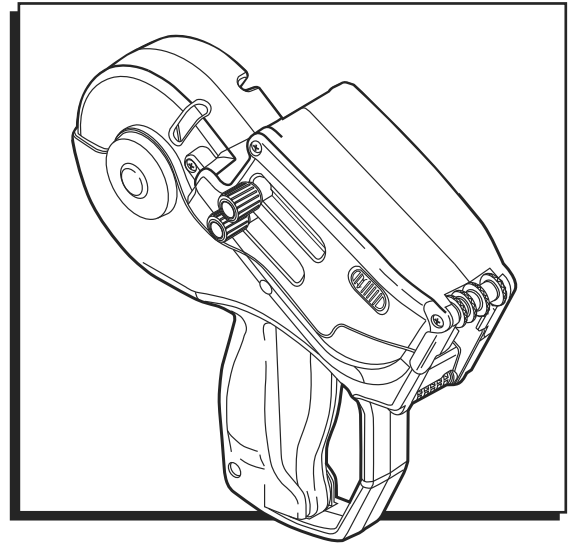

OPERATION

CHANGING THE INK ROLLER

1. Pull the latches back and swing the cover open until it clicks.

 **NOTE:** Do not force the cover past the click position.

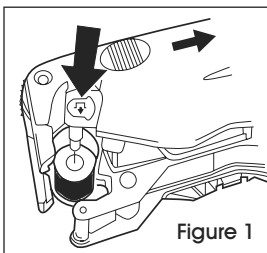

Figure 1

2. Hold the labeler sideways over a trash can while pushing the button to release the ink roller. (See Figure 1)

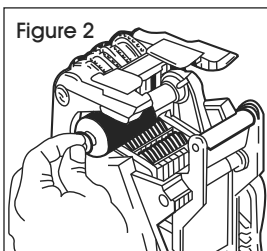

Figure 2

3. Hold the new ink roller by the stem. (See Figure 2)
4. Slide ink roller onto the post, snapping it into place. (See Figure 2)

5. Close the cover completely.

SETTING PRINT CHARACTERS

1. Pull the knob until the indicators are on the desired band.

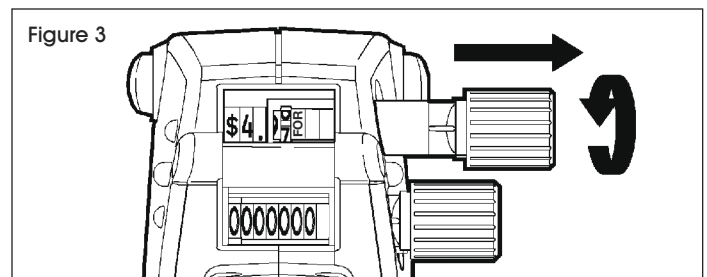

Figure 3

2. Turn the knob until the desired character appears black on a white background between the indicators. To print a blank, select the blank space for that band. (See Figure 3)
3. Repeat steps 1-2 for each band.
4. Push in the knob when done.

LOADING LABELS

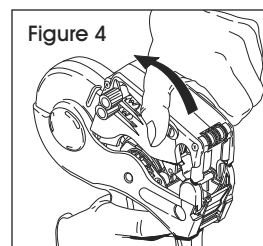

Figure 4

1. Pull the latches back and swing the cover open until it clicks. (See Figure 4)

 **NOTE:** Do not force the cover past the click position.

2. For loading a new roll of labels, tear off and discard the first 10" of label and liner.
3. To prevent jamming, peel the first 12 labels from liner and discard.

OPERATION CONTINUED

- Place the label roll between the hubs and click into place. (See Figure 5)

 **NOTE:** Do not thread label strip through any rollers.

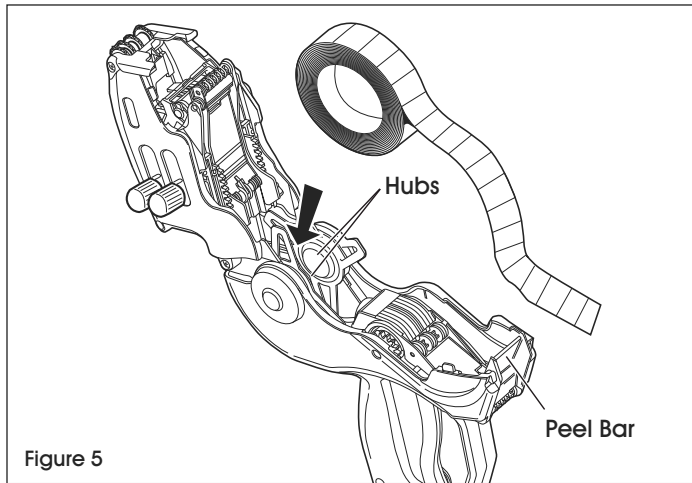

- Drape the supply across the labeler and center it over the peel bar. The supply should hang out 5-6" past the peel bar.
- Close the cover.
- Squeeze and hold the trigger while feeding the label strip under the roller and into the large slot above the arrow until it stops/hits the back. (See Figure 6)
- Hold the strip in place and squeeze the trigger eight times or until the label strip feeds through the rear exit.
- Remove any loose labels.

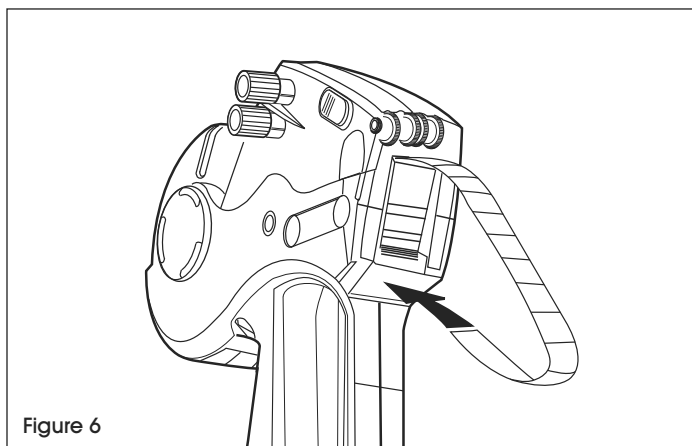

CLEARING LABEL JAMS, CLEANING AND LUBRICATION

- Open the cover and remove the label roll.
- Remove any loose labels from the inside of the labeler. (See Figure 7)

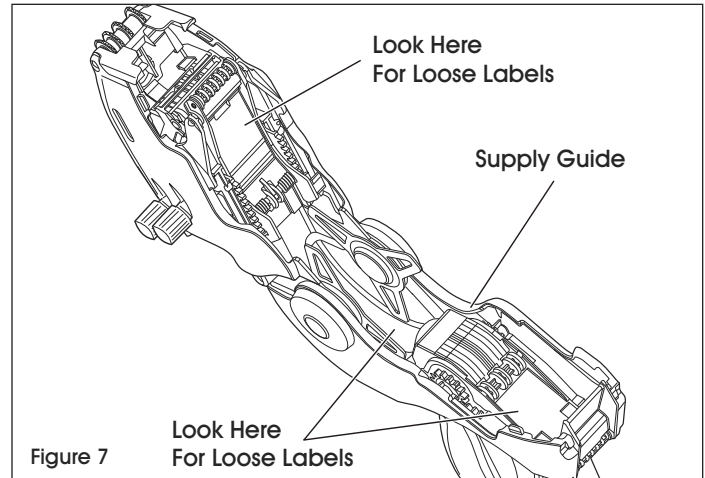

- Pull up on the supply guide to expose the backing paper path and remove loose labels. (See Figure 8)

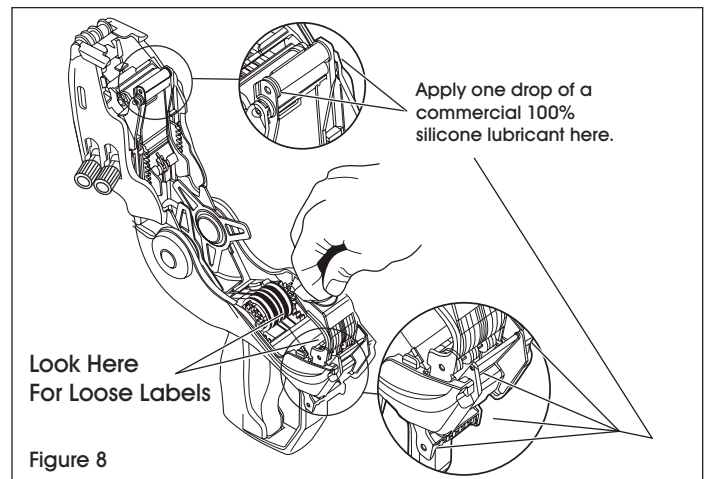

- Snap the supply guide back into place.
- Use a commercial adhesive solvent to clean adhesive buildup.
- Remove the ink roller to expose the print bands and brush them off with a toothbrush.
- Reload, then close the cover.

CHARACTER KEY

Regular Font (3 MM) 1st Line

KNOB POSITION							
1	2	3	4	5	6	7	8
.
1	1	1	1	1	1	1	1
2	2	2	2	2	2	2	2
3	3	3	3	3	3	3	3
4	4	4	4	4	4	4	4
5	5	5	5	5	5	5	5
6	6	6	6	6	6	6	6
7	7	7	7	7	7	7	7
8	8	8	8	8	8	8	8
9	9	9	9	9	9	9	9
0	0	0	0	0	0	0	0
\$	\$	\$	\$	\$	\$	+TX	+TX
WAS	WAS	WAS	WAS	WAS	WAS	,	,
FOR	FOR	FOR	FOR	FOR	FOR	OFF	OFF
¢	¢	¢	¢	¢	¢	EA	EA
/	/	/	/	/	/	1/2	1/2
-	-	-	-	-	-	¢	¢

Regular Font (5 MM) 2nd Line

KNOB POSITION							
1	2	3	4	5	6	7	8
1	1	1	.	.	1	1	LB
2	2	2	1	1	2	2	EACH
3	3	3	2	2	3	3	FOOT
4	4	4	3	3	4	4	YARD
5	5	5	4	4	5	5	DOZ
6	6	6	5	5	6	6	PAIR
7	7	7	6	6	7	7	PKG
8	8	8	7	7	8	8	BOX
9	9	9	8	8	9	9	CASE
0	0	0	9	9	0	0	SET
\$	\$	\$	0	0	+TX	+TX	OFF
FOR	FOR	FOR	/	/	EACH	OFF	+DEP
/	/	/	-	-	¢	¢	+TX

NOT INDICATIVE OF FONT SIZE AND STYLE.

ULINE

1-800-295-5510
uline.com

MONARCH 1136®

PISTOLA ETIQUETADORA NUMÉRICA - DOS LÍNEAS

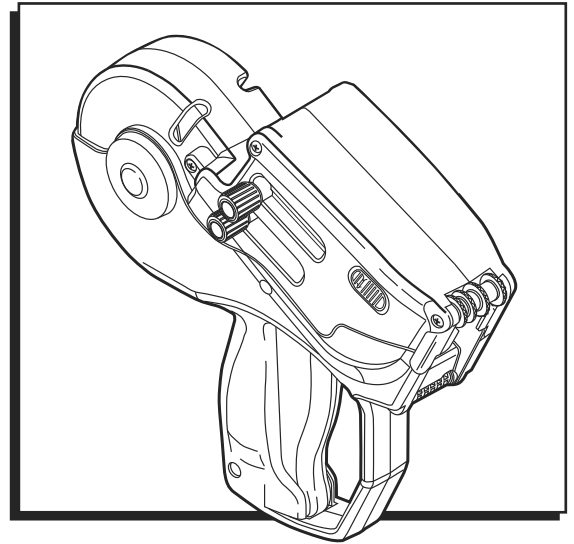

FUNCIONAMIENTO

CAMBIAR EL RODILLO DE TINTA

1. Jale los seguros y abra la cubierta hasta escuchar un clic.

 **NOTA:** No fuerce la cubierta después de escuchar el clic.

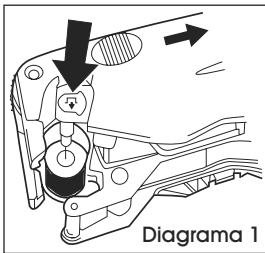

2. Sostenga los laterales de la etiquetadora sobre un bote de basura mientras presiona el botón para liberar el rodillo de tinta. (Vea Diagrama 1)

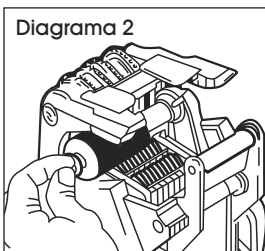

3. Sostenga el nuevo rodillo de tinta por el vástago. (Vea Diagrama 2)
4. Empuje el rodillo de tinta hacia el poste hasta que quede en su lugar. (Vea Diagrama 2)

5. Cierre la cubierta completamente.

CONFIGURAR CARACTERES DE IMPRESIÓN

1. Jale la perilla hasta que los indicadores estén sobre la banda deseada.

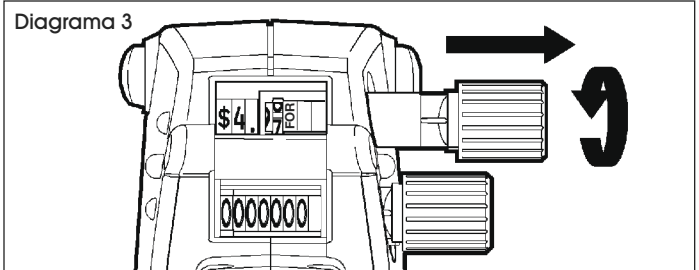

2. Gire la perilla hasta que el caracter deseado aparezca negro sobre fondo blanco entre los indicadores. Para imprimir un espacio en blanco, seleccione el espacio en blanco en esa banda. (Vea Diagrama 3)
3. Repita los pasos 1-2 para cada banda.
4. Presione la perilla hacia adentro cuando haya terminado.

CARGAR ETIQUETAS

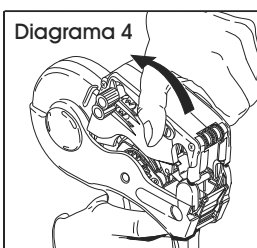

1. Jale los pestillos y mueva la cubierta hasta que se abra con un clic. (Vea Diagrama 4)

 **NOTA:** No fuerce la cubierta después de escuchar el clic.

2. Para cargar un nuevo rollo de etiquetas, desprendo y deseche los primeros 25 cm (10") de etiquetas y respaldo.
3. Para prevenir el atascamiento, despegue las primeras 12 etiquetas del respaldo y deséchelas.

CONTINUACIÓN DE FUNCIONAMIENTO

- Coloque el rollo de etiquetas entre los núcleos y presione hasta que quede en su lugar. (Vea Diagrama 5)

 **NOTA:** No haga pasar la tira de etiquetas a través de ninguno de los rodillos.

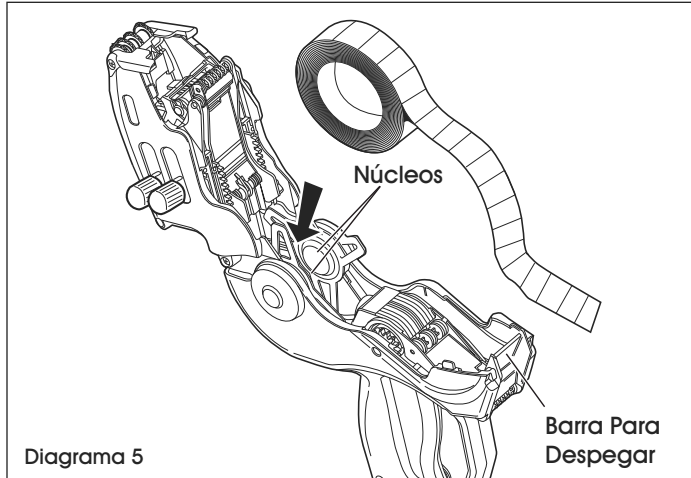

- Deje colgando un tramo del suministro a través de la etiquetadora y céntralo sobre la barra para despegar. El tramo de suministro deberá colgar 13-15 cm (5-6") pasando la barra para despegar.
- Cierre la cubierta.
- Apriete y sostenga el gatillo mientras alimenta la tira de etiquetas debajo del rodillo y dentro de la ranura grande arriba de la flecha hasta que pare/pegue en la parte posterior. (Vea Diagrama 6)
- Sostenga la tira en su lugar y apriete el gatillo ocho veces o hasta que la tira de etiquetas salga por la parte posterior.
- Retire cualquier etiqueta suelta.

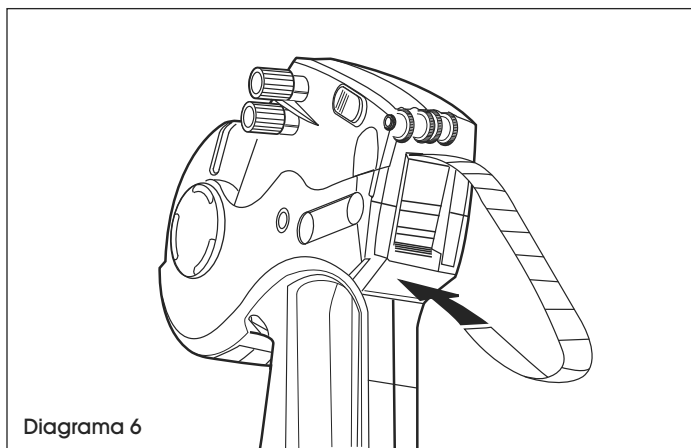

DESPEJAR ATASCOS DE ETIQUETAS, LIMPIEZA Y LUBRICACIÓN

- Abra la cubierta y retire el rollo de etiquetas.
- Retire cualquier etiqueta suelta del interior de la etiquetadora. (Vea Diagrama 7)

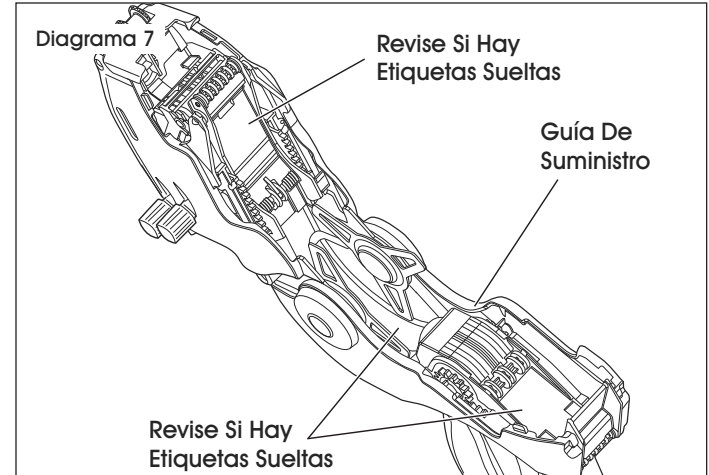

- Jale la guía de suministro hacia arriba para exponer el trayecto del respaldo de papel y retire las etiquetas sueltas. (Vea Diagrama 8)

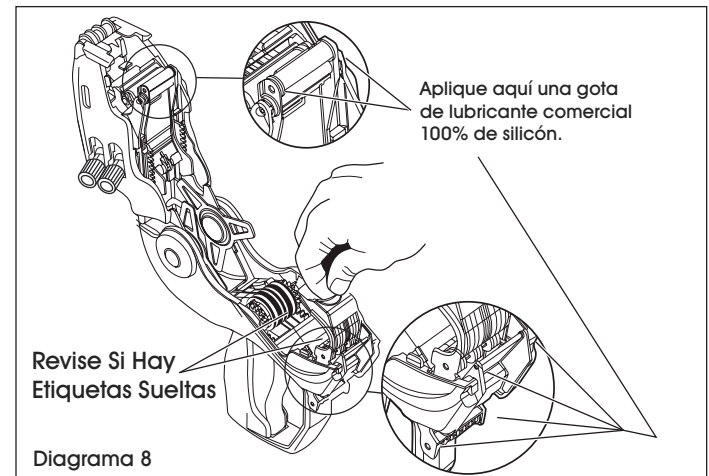

- Colóquelo de vuelta en su lugar.
- Utilice un solvente de adhesivo comercial para limpiar la acumulación de adhesivo.
- Retire el rodillo de tinta para exponer las bandas de impresión y cepílelas con un cepillo dental.
- Recargue, luego cierre la cubierta.

CLAVE DE CARACTERES

Letra Regular (3 MM) 1a. Línea

POSICIÓN DE LA PERILLA							
1	2	3	4	5	6	7	8
.
1	1	1	1	1	1	1	1
2	2	2	2	2	2	2	2
3	3	3	3	3	3	3	3
4	4	4	4	4	4	4	4
5	5	5	5	5	5	5	5
6	6	6	6	6	6	6	6
7	7	7	7	7	7	7	7
8	8	8	8	8	8	8	8
9	9	9	9	9	9	9	9
0	0	0	0	0	0	0	0
\$	\$	\$	\$	\$	\$	+TX	+TX
WAS	WAS	WAS	WAS	WAS	WAS	,	,
FOR	FOR	FOR	FOR	FOR	FOR	OFF	OFF
¢	¢	¢	¢	¢	¢	EA	EA
/	/	/	/	/	/	1/2	1/2
-	-	-	-	-	-	¢	¢

Letra Regular (5 MM) 2a. Línea

POSICIÓN DE LA PERILLA							
1	2	3	4	5	6	7	8
1	1	1	.	.	1	1	LB
2	2	2	1	1	2	2	EACH
3	3	3	2	2	3	3	FOOT
4	4	4	3	3	4	4	YARD
5	5	5	4	4	5	5	DOZ
6	6	6	5	5	6	6	PAIR
7	7	7	6	6	7	7	PKG
8	8	8	7	7	8	8	BOX
9	9	9	8	8	9	9	CASE
0	0	0	9	9	0	0	SET
\$	\$	\$	0	0	+TX	+TX	OFF
FOR	FOR	FOR	/	/	EACH	OFF	+DEP
/	/	/	-	-	¢	¢	+TX

NO INDICA EL TAMAÑO Y ESTILO DE LETRA.

ULINE

800-295-5510
uline.mx

ULINE H-992

MONARCH 1136^{MD}
PISTOLET-ÉTIQUETEUSE
À DEUX LIGNES

1 800 295-5510
uline.ca

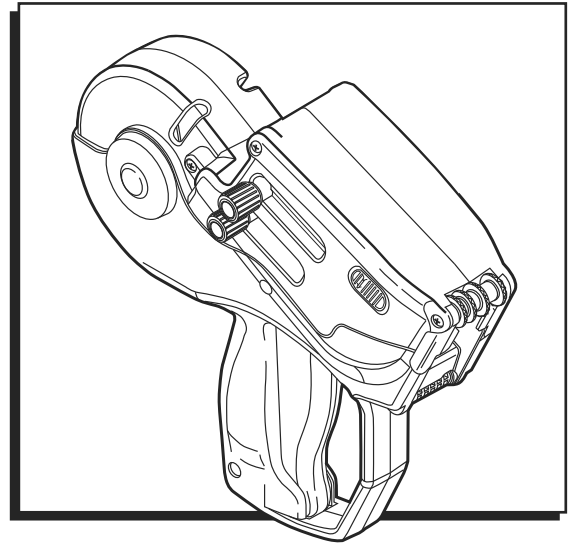

FONCTIONNEMENT

CHANGEMENT DU ROULEAU ENCREUR

1. Tirez les loquets vers l'arrière et ouvrez le couvercle jusqu'à ce qu'il s'enclenche.

 **REMARQUE : Ne forcez pas le couvercle au-delà de la position du déclic.**

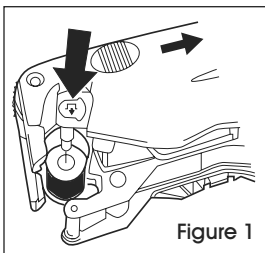

Figure 1

2. Tenez l'étiqueteuse de côté au-dessus d'une poubelle tout en poussant le bouton pour libérer le rouleau encreur. (Voir Figure 1)

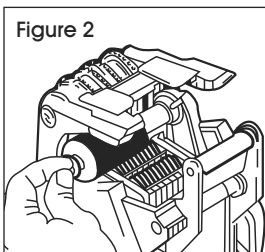

Figure 2

3. Tenez le nouveau rouleau encreur par sa tige. (Voir Figure 2)
4. Faites glisser le rouleau encreur sur le montant en l'enclenchant en place. (Voir Figure 2)

5. Fermez le couvercle complètement.

RÉGLAGE DES CARACTÈRES IMPRIMÉS

1. Tirez sur le bouton jusqu'à ce que les indicateurs soient sur la bande désirée.

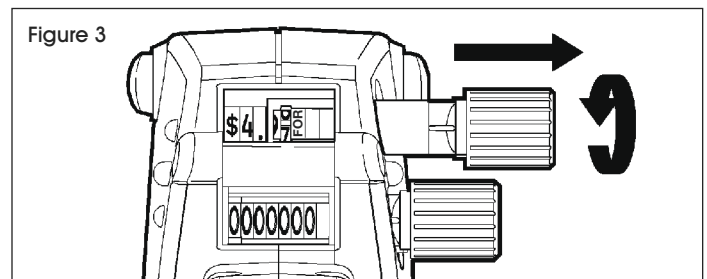

Figure 3

2. Tournez le bouton jusqu'à ce que le caractère souhaité apparaisse en noir sur fond blanc entre les indicateurs. Pour imprimer un blanc, sélectionnez l'espace en blanc pour cette bande. (Voir Figure 3)
3. Répétez les étapes 1 et 2 pour chaque bande.
4. Appuyez sur le bouton lorsque vous avez terminé.

CHARGEMENT DES ÉTIQUETTES

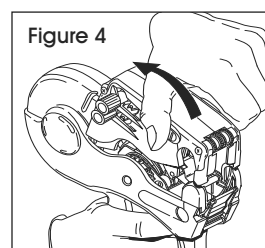



Figure 4

1. Tirez les loquets vers l'arrière et ouvrez le couvercle jusqu'à ce qu'il s'enclenche. (Voir Figure 4)

 **REMARQUE : Ne forcez pas le couvercle au-delà de la position du déclic.**

2. Pour charger un nouveau rouleau d'étiquettes, arrachez et jetez les 25 cm (10 po) initiaux d'étiquettes et de doublure.
3. Pour prévenir le bouchage, décollez les 12 premières étiquettes de la doublure et jetez-les.

FONCTIONNEMENT SUITE

- Placez le rouleau d'étiquettes entre les moyeux et enclenchez-le. (Voir Figure 5)



REMARQUE : N'enfilez pas de bande d'étiquettes au travers des rouleaux.

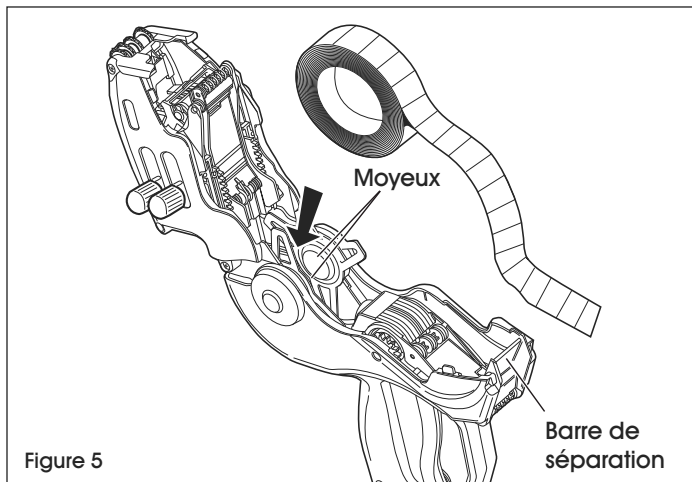

- Déposez la bande sur l'étiqueteuse et centrez-la sur la barre de séparation. La bande devrait dépasser de 13 à 15 cm (5 à 6 po) au-delà de la barre de séparation.
- Fermez le couvercle.
- Pressez et maintenez la détente enfoncée tout en alimentant la bande d'étiquettes sous le rouleau et jusque dans la grande fente au-dessus de la flèche, jusqu'à ce qu'elle s'arrête ou atteigne l'arrière. (Voir Figure 6)
- Maintenez la bande en place et appuyez sur la détente huit fois ou jusqu'à ce que la bande d'étiquettes émerge de la sortie arrière.
- Enlevez toute étiquette lâche.

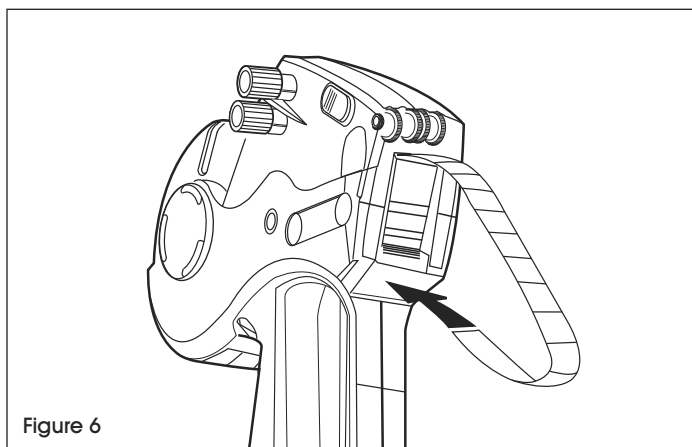

DÉPANNAGE DES BOURRAGES, NETTOYAGE ET LUBRIFICATION

- Ouvrez le couvercle et retirez le rouleau d'étiquettes.
- Enlevez toute étiquette lâche à l'intérieur de l'étiqueteuse. (Voir Figure 7)

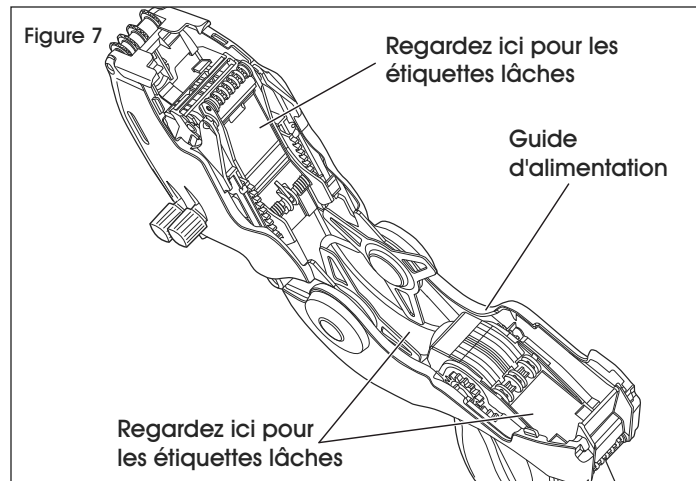

- Tirez sur le guide d'alimentation pour révéler le chemin du papier dorsal et retirer les étiquettes lâches. (Voir Figure 8)

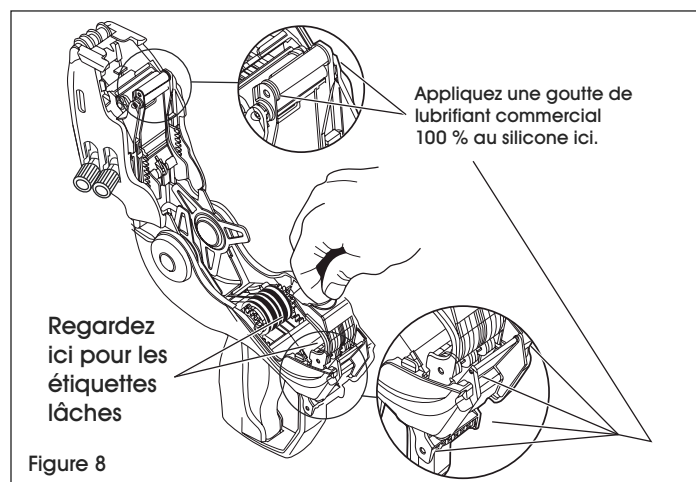

- Encliquez le guide d'alimentation dans sa position originale.
- Utilisez un solvant commercial pour adhésif afin de nettoyer l'accumulation d'adhésif.
- Retirez le rouleau encreur pour exposer les bandes d'impression, et nettoyez-les avec une brosse à dents.
- Rechargez, puis fermez le couvercle.

TOUCHE DE CARACTÈRE

Police régulière (3 MM) 1 re ligne

POSITION DU BOUTON							
1	2	3	4	5	6	7	8
.
1	1	1	1	1	1	1	1
2	2	2	2	2	2	2	2
3	3	3	3	3	3	3	3
4	4	4	4	4	4	4	4
5	5	5	5	5	5	5	5
6	6	6	6	6	6	6	6
7	7	7	7	7	7	7	7
8	8	8	8	8	8	8	8
9	9	9	9	9	9	9	9
0	0	0	0	0	0	0	0
\$	\$	\$	\$	\$	\$	+TX	+TX
WAS	WAS	WAS	WAS	WAS	WAS	,	,
FOR	FOR	FOR	FOR	FOR	FOR	OFF	OFF
¢	¢	¢	¢	¢	¢	EA	EA
/	/	/	/	/	/	1/2	1/2
-	-	-	-	-	-	¢	¢

Police régulière (5 MM) 2 nd ligne

POSITION DU BOUTON							
1	2	3	4	5	6	7	8
1	1	1	.	.	1	1	LB
2	2	2	1	1	2	2	EACH
3	3	3	2	2	3	3	FOOT
4	4	4	3	3	4	4	YARD
5	5	5	4	4	5	5	DOZ
6	6	6	5	5	6	6	PAIR
7	7	7	6	6	7	7	PKG
8	8	8	7	7	8	8	BOX
9	9	9	8	8	9	9	CASE
0	0	0	9	9	0	0	SET
\$	\$	\$	0	0	+TX	+TX	OFF
FOR	FOR	FOR	/	/	EACH	OFF	+DEP
/	/	/	-	-	¢	¢	+TX

PAS REPRESENTATIF DE LA TAILLE OU DU STYLE DE POLICE.

ULINE

1 800 295-5510
uline.ca