

# ULINE S-7880 COUNTER DISPLAY TRAY

1-800-295-5510  
uline.com

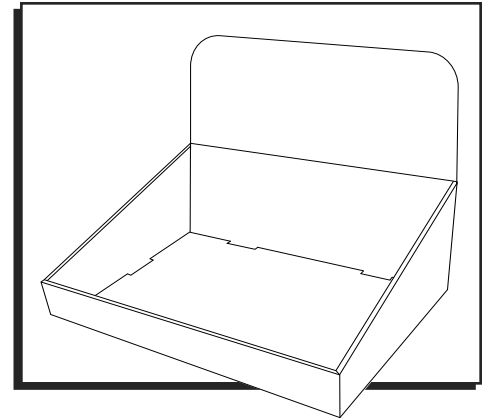

## ASSEMBLY

1. Lay the display on a flat, clean surface. (See Figure 1)

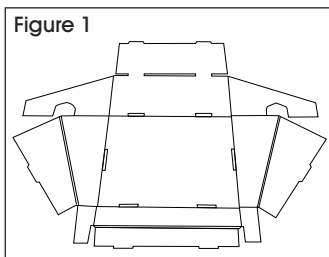

2. With the kraft side facing up, fold the back panel up and over until it locks into place. (See Figure 2)

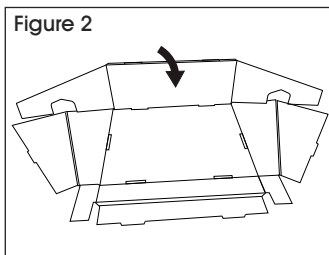

3. Fold the angled flaps in so they are perpendicular with the back panel. (See Figure 3)

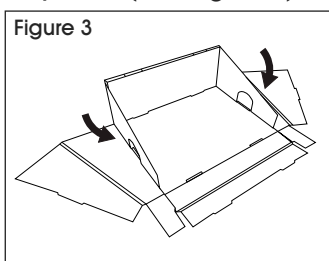

4. Fold the sides up and over angled flaps until they lock into place. (See Figures 4-5)

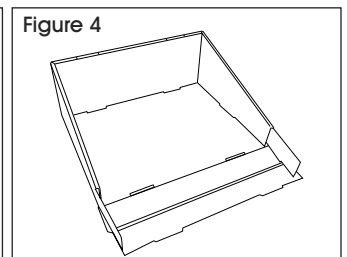
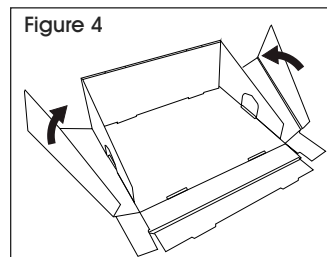

5. Fold front flaps in. (See Figure 6)

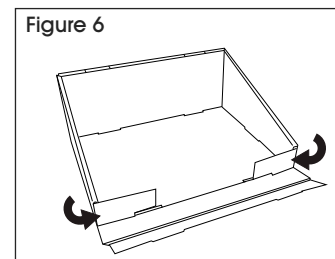

6. Fold the front panel up and over front flaps until it locks into place. (See Figure 7)

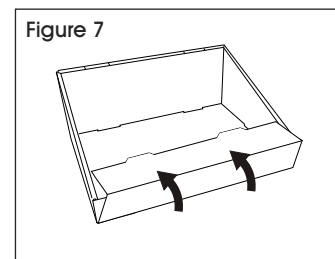

7. Add header to the top of display. (See Figure 8)

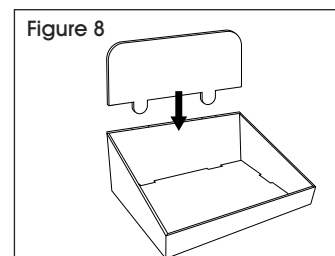

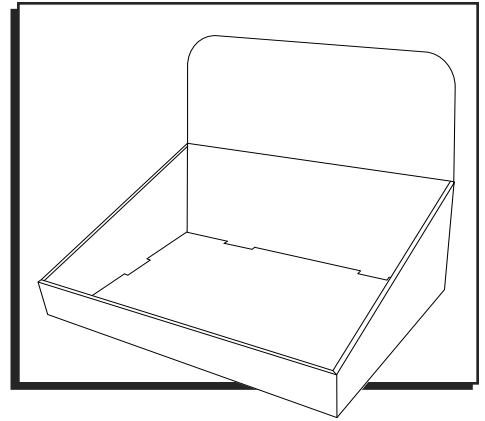
**ASSEMBLY**

1. Coloque la estructura sobre una superficie plana y limpia. (Vea Diagrama 1)

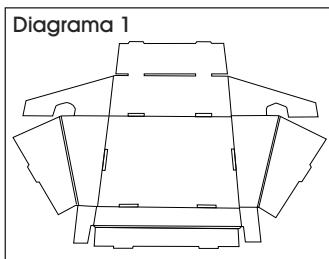

2. Con la parte kraft hacia arriba, doble el panel trasero hacia el frente y adentro hasta que se atore en su lugar. (Vea Diagrama 2)

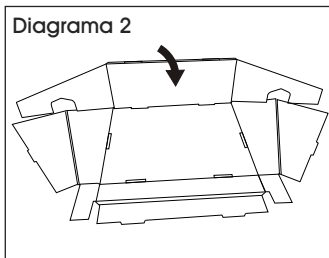

3. Doble las pestañas anguladas de manera que queden perpendiculares con el panel trasero. (Vea Diagrama 3)

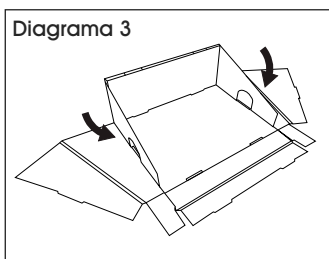

4. Doble los laterales hacia arriba y sobre las pestañas angulares hasta que se atoren en su lugar. (Vea Diagramas 4-5)

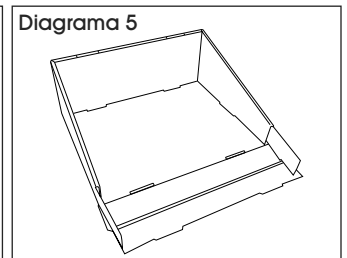
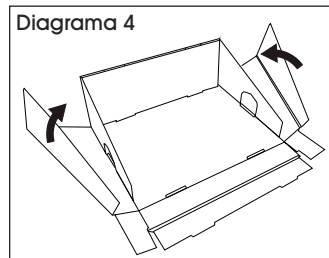

5. Doble las pestañas frontales hacia adentro. (Vea Diagrama 6)

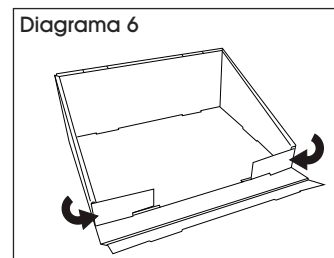

6. Doble el panel frontal hacia el frente y adentro hasta que se atore en su lugar. (Vea Diagrama 7)

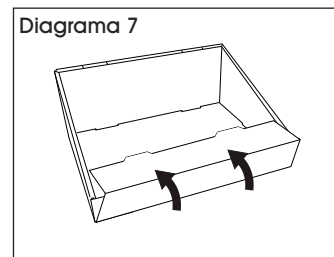

7. Agregue la pestaña superior del exhibidor. (Vea Diagrama 8)

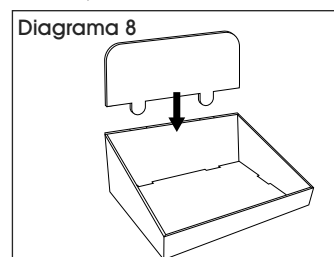

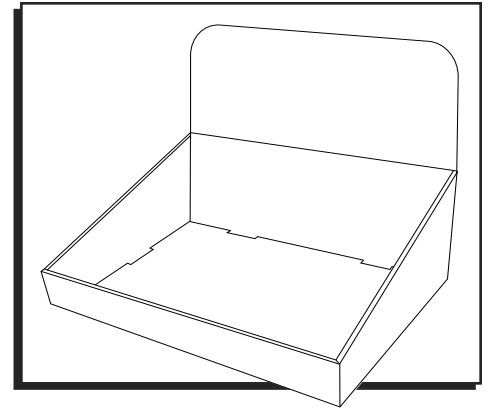

## ASSEMBLY

1. Posez le présentoir sur une surface propre et plate.  
(Voir Figure 1)

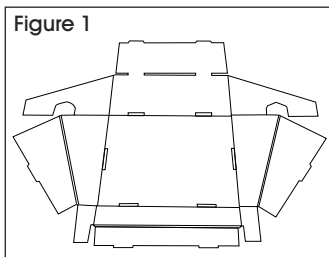

2. En ayant le côté kraft orienté vers le haut, pliez le panneau arrière vers le haut et en dessus jusqu'à ce qu'il se verrouille en place. (Voir Figure 2)

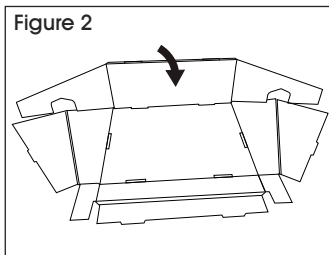

3. Pliez les rabats anglés vers l'intérieur de manière à ce qu'ils soient perpendiculaires avec le panneau arrière. (Voir Figure 3)

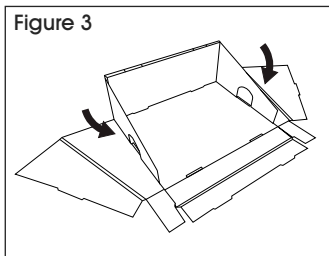

4. Pliez les côtés latéraux vers le haut et en dessus les rabats anglés jusqu'à ce qu'ils se verrouillent en place. (Voir Figures 4-5)

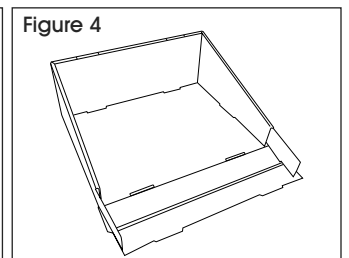
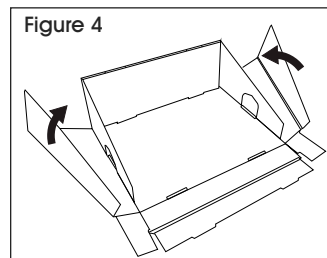

5. Pliez les rabats avant vers l'intérieur. (Voir Figure 6)

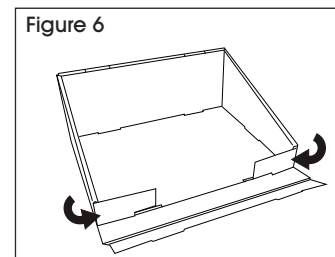

6. Pliez le panneau avant vers le haut et en dessus des rabats avant jusqu'à ce qu'il se verrouille en place. (Voir Figure 7)

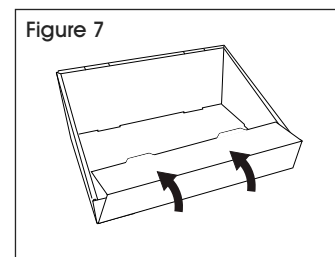

7. Ajoutez une en-tête au dessus du présentoir. (Voir Figure 8)

