

**ULINE** S-9731, S-13352  
S-13353  
**CLEAR VINYL BOXES**

1-800-295-5510  
uline.com

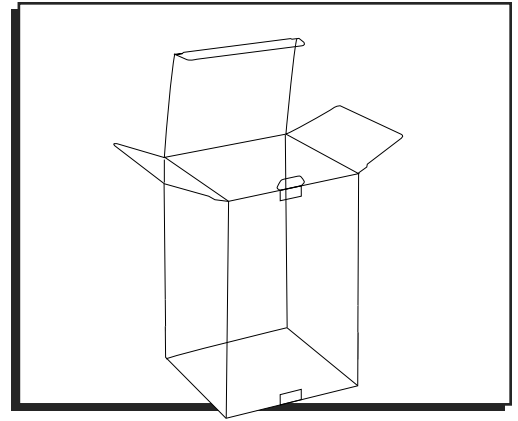

## ASSEMBLY

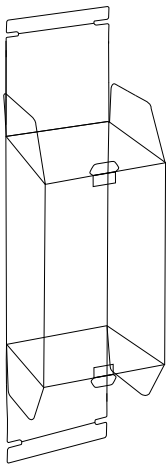

Figure 1

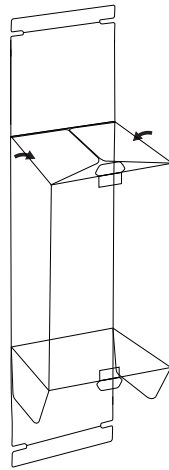

Figure 2

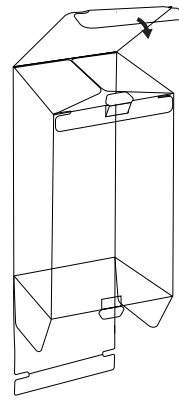

Figure 3

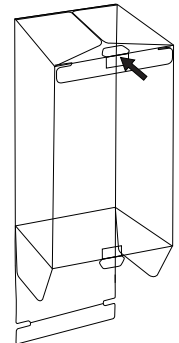

Figure 4

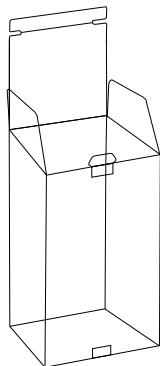

Figure 5

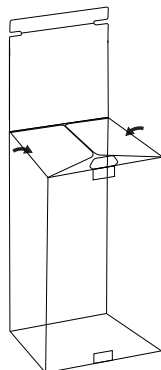

Figure 6

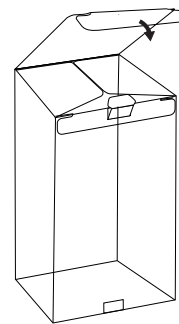

Figure 7

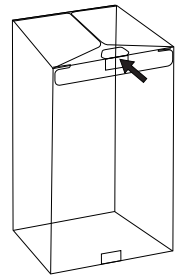

Figure 8

1. Open and crease edges to create box.

### TO CLOSE BOTTOM

1. Crease edges. (See Figure 1)
2. Fold down side flaps. (See Figure 2)
3. Tuck bottom closed. (See Figure 3)
4. Insert tab to secure closure. (See Figure 4)

### TO CLOSE TOP

1. Flip box over and crease edges. (See Figure 5)
2. Fold down side flaps. (See Figure 6)
3. Tuck top closed. (See Figure 7)
4. Insert tab to secure closure. (See Figure 8)

**ENSAMBLE**

Diagrama 1



Diagrama 2

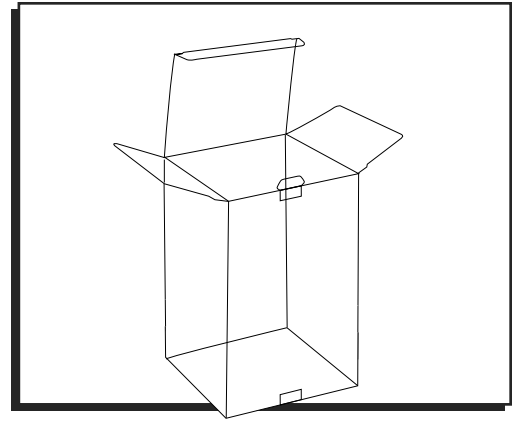
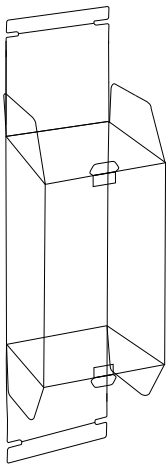

Diagrama 3

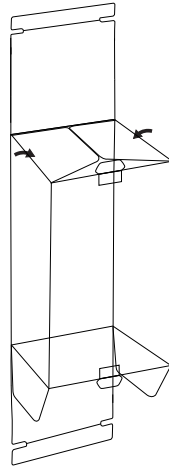

Diagrama 4

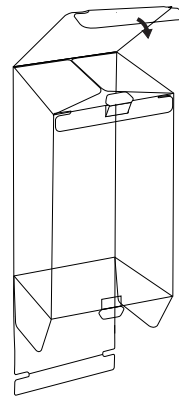

Diagrama 5

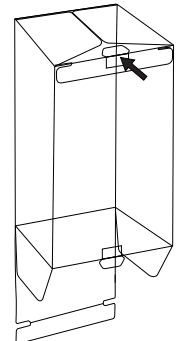

Diagrama 6

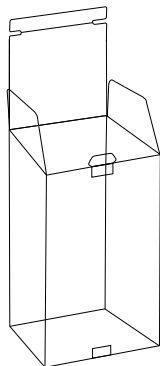

Diagrama 7

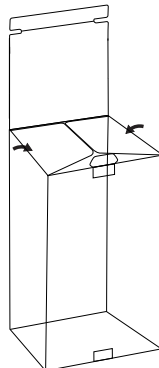

Diagrama 8

1. Abra y pliegue los bordes para crear la caja.

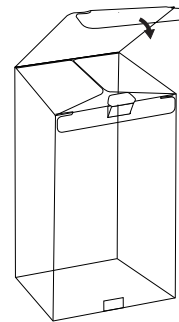
**PARA CERRAR LA BASE**

1. Pliegue los bordes. (Vea Diagrama 1)
2. Doble las solapas laterales. (Vea Diagrama 2)
3. Inserte la base hasta cerrar. (Vea Diagrama 3)
4. Inserte la pestaña para asegurar el cierre. (Vea Diagrama 4)

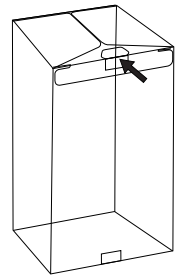
**PARA CERRAR LA TAPA**

1. Voltee la caja y pliegue los bordes. (Vea Diagrama 5)
2. Doble las solapas laterales. (Vea Diagrama 6)
3. Inserte la tapa hasta cerrar. (Vea Diagrama 7)
4. Inserte la pestaña para asegurar el cierre. (Vea Diagrama 8)

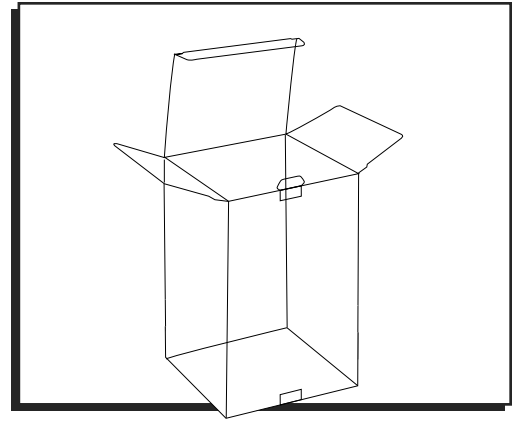

## ASSEMBLAGE

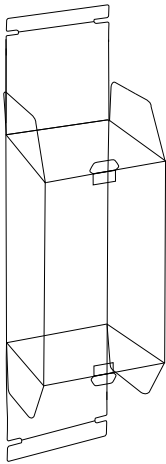

Figure 1

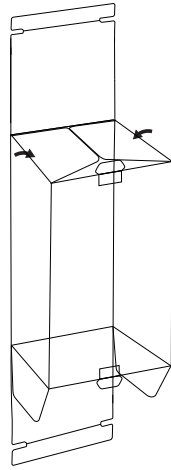

Figure 2

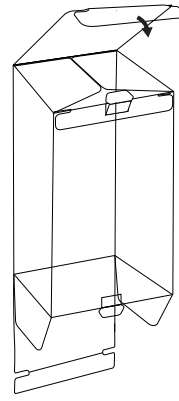

Figure 3

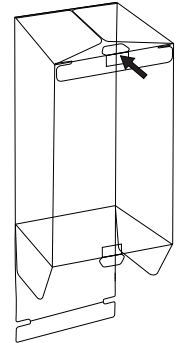

Figure 4

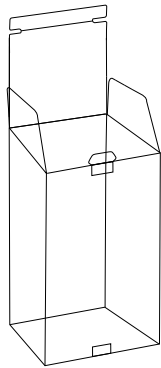

Figure 5

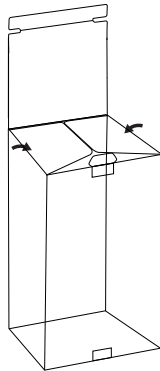

Figure 6

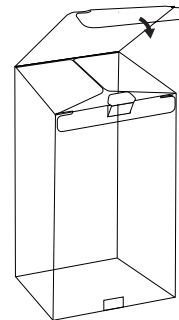

Figure 7

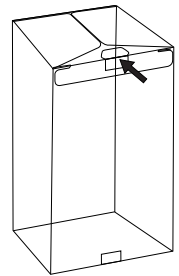

Figure 8

1. Ouvrez et pliez les rebords pour donner la forme de la boîte.

### POUR FERMER LE FOND

1. Pliez les rebords. (Voir Figure 1)
2. Pliez les rabats latéraux vers le bas. (Voir Figure 2)
3. Fermez le fond en faisant rentrer le rabat. (Voir Figure 3)
4. Insérez la languette pour assurer la fermeture. (Voir Figure 4)

### POUR FERMER LE COUVERCLE

1. Retournez la boîte et pliez les rebords. (Voir Figure 5)
2. Pliez les rabats latéraux vers le bas. (Voir Figure 6)
3. Fermez le couvercle en faisant rentrer le rabat. (Voir Figure 7)
4. Insérez la languette pour assurer la fermeture. (Voir Figure 8)