

ULINE H-3376

MAGLINER® ALUMINUM STANDARD HAND TRUCK WITH PNEUMATIC WHEELS

1-800-295-5510
 uline.com

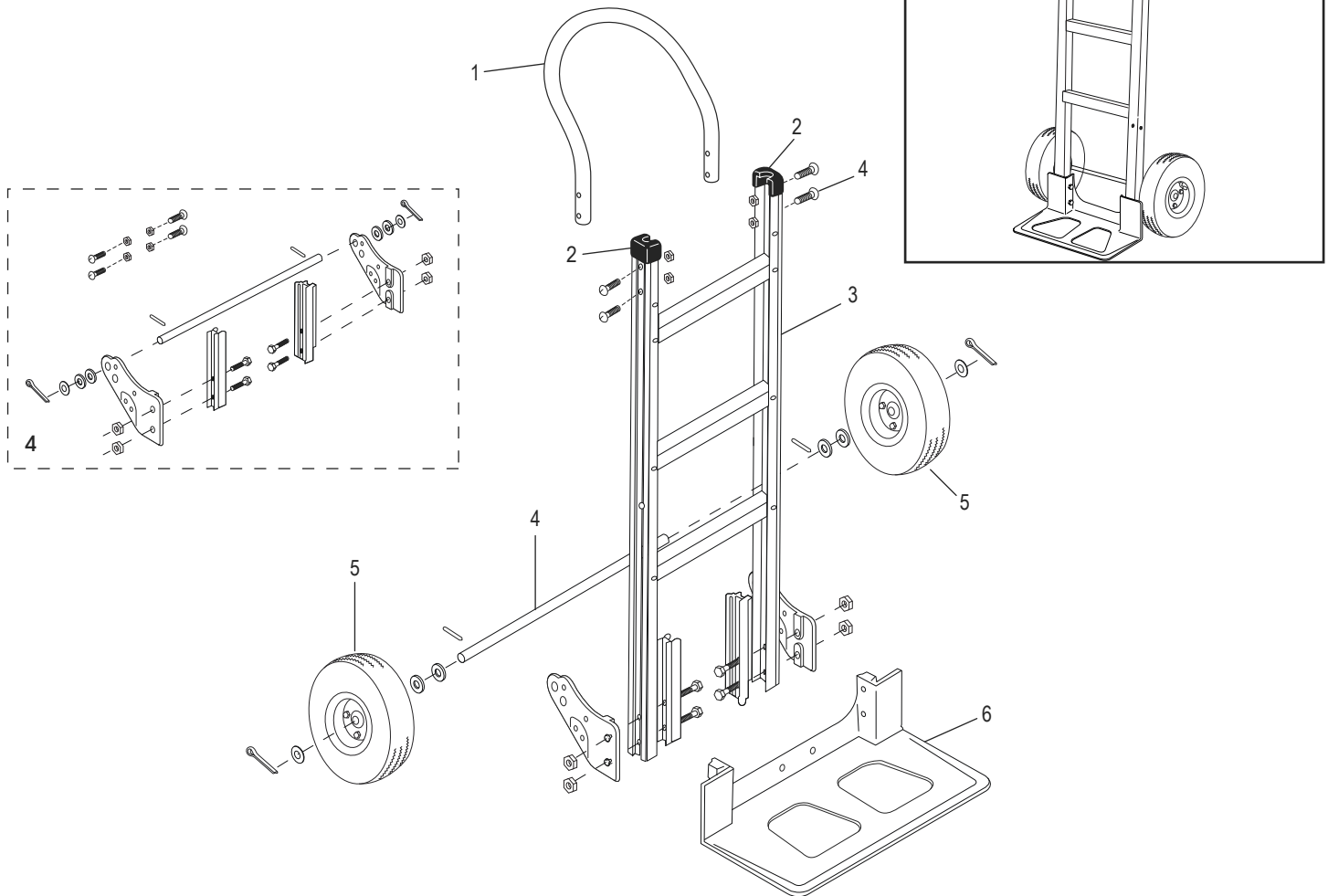

#	DESCRIPTION	QTY.	ULINE PART NO.	MFG. PART NO.
1	Handle	1	H-1054HANDLE	301000
2	Black Cap	2	H-1054-CAP	302498
3	Frame	1	H-1054FRAME	300001
4	Hardware Kit* Includes: • 1/4"-20 x 1 1/2" - Pan Head Bolts (4) • 1/4" - Locknuts (4) • Axle (1) • Right Hand (RH) Wheel Bracket (1) • Left Hand (LH) Wheel Bracket (1) • Side Channel Reinforcements (2) • 5/16"-18 x 2 1/4" - Hex Head Bolts (4) • 5/16" - Locknuts (4) • Thick Washers (4) • Thin Washers (4) • Pin Coil Spring/Roll Pins (2) • Cotter Pins (2)	1	H-1006-HRDWR	301040
5	Wheel	2	H-3380	121060
6	Nose Plate	1	H-1054-ANOSE	300200

*Includes additional hardware not required for assembly.

ULINE H-3376

MAGLINER® DIABLITO DE ALUMINIO ESTÁNDAR CON LLANTAS NEUMÁTICAS

800-295-5510

uline.mx

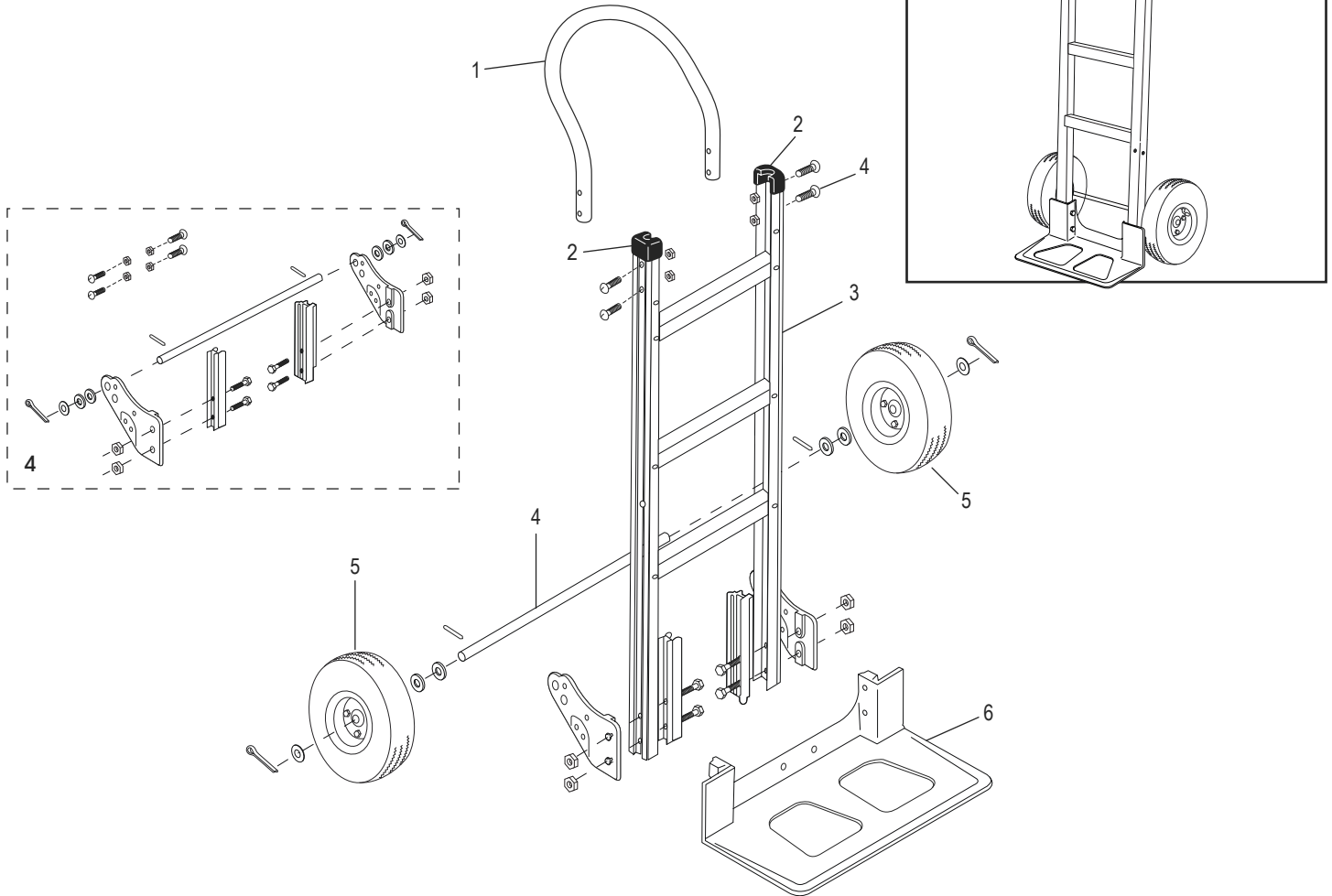

#	DESCRIPCIÓN	CANT.	NO. DE PARTE DE ULINE	NO. DE PARTE DEL FABRICANTE
1	Asa	1	H-1054HANDLE	301000
2	Tapa Negra	2	H-1054-CAP	302498
3	Armazón	1	H-1054FRAME	300001
4	Kit de tornillería* Incluye: • 1/4"-20 x 1 1/2" - Pernos de cabeza alomada (4) • 1/4" - Tuercas de Seguridad (4) • Eje (1) • Soporte de la Llanta Derecho (mano derecha) (1) • Soporte de la Llanta Izquierdo (mano izquierda) (1) • Refuerzos del Canal Lateral (2) • 5/16"-18 x 2 1/4" - Pernos de Cabeza Hexagonal (4) • 5/16" - Tuercas de Seguridad (4) • Rondanas Gruesas (4) • Rondanas Finas (4) • Clavijas tipo Resorte/Clavija del Rodillo (2) • Pasadores de Chaveta (2)	1	H-1006-HRDWR	301040
5	Llanta	2	H-3380	121060
6	Placa Delantera	1	H-1054-ANOSE	300200

*Se incluyen piezas adicionales que no son necesarias para el ensamble.

ULINE H-3376
MAGLINER^{MD} DIABLE DE
MANUTENTION STANDARD
EN ALUMINIUM
AVEC ROUES PNEUMATIQUES

1-800-295-5510
 uline.ca

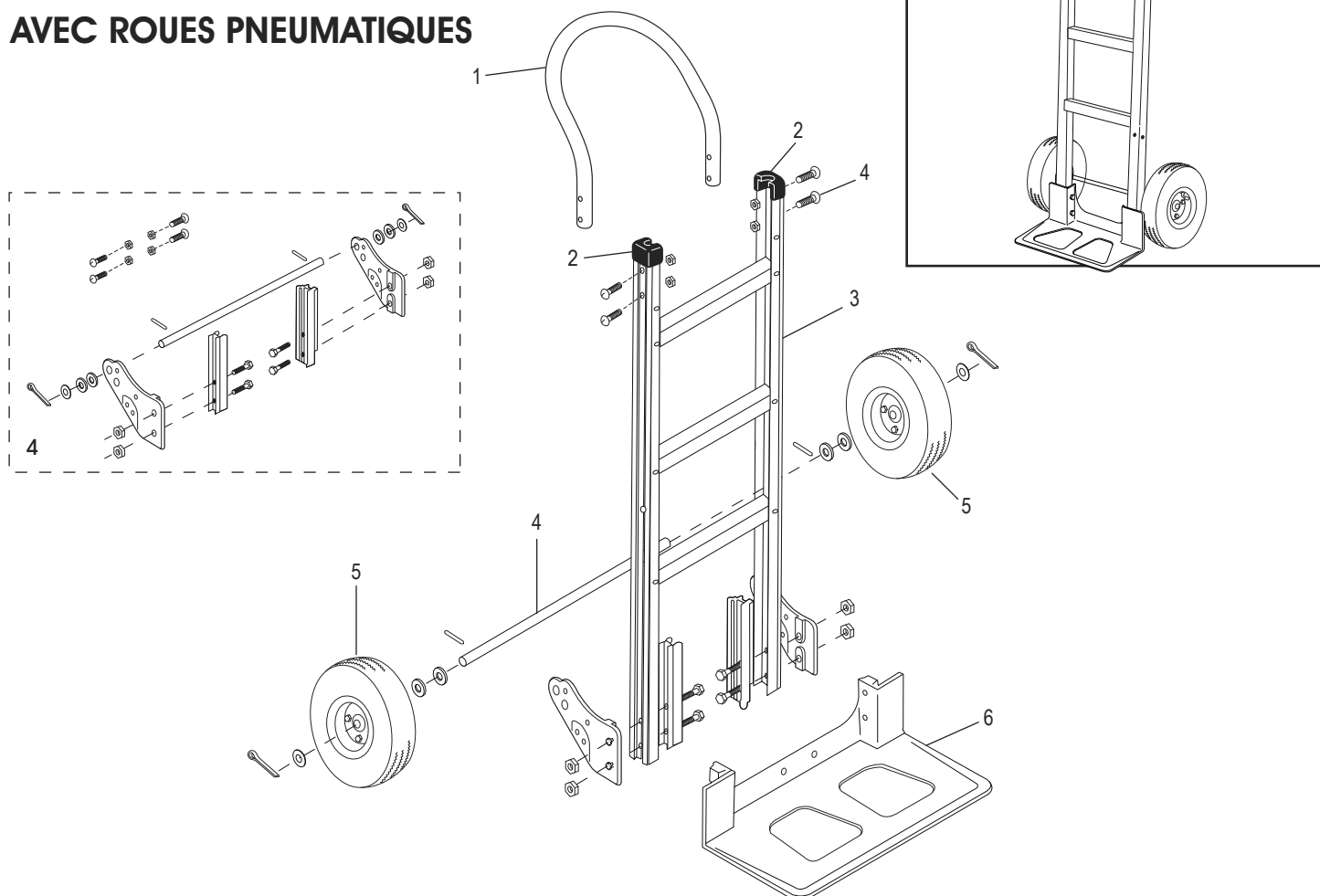

#	DESCRIPTION	QTÉ	RÉF. ULINE	RÉF. DE FABRICATION
1	Poignée	1	H-1054HANDLE	301000
2	Capuchon noir	2	H-1054-CAP	302498
3	Cadre	1	H-1054FRAME	300001
4	Ensemble de quincaillerie* comprend : <ul style="list-style-type: none"> • Vis à tête cylindrique de 1/4 po-20 x 1 1/2 po (4) • Écrous freinés de 1/4 po (4) • Essieu (1) • Support de roue (droit) (1) • Support de roue (gauche) (1) • Renforts de rainure latéraux (2) • Boulons à tête hexagonale de 5/16 po-18 x 2 1/4 po (4) • Écrous freinés de 5/16 po (4) • Rondelles épaisses (4) • Rondelles fines (4) • Goupilles cylindriques/Ressort hélicoïdal (2) • Goupilles fendues (2) 	1	H-1006-HRDWR	301040
5	Roue	2	H-3380	121060
6	Bavette	1	H-1054-ANOSE	300200

*Comprend de la quincaillerie supplémentaire non nécessaire à l'assemblage.