

ULINE S-25171
1 PINT PLASTIC PAINT
CAN WITH LID

1-800-295-5510
 uline.com

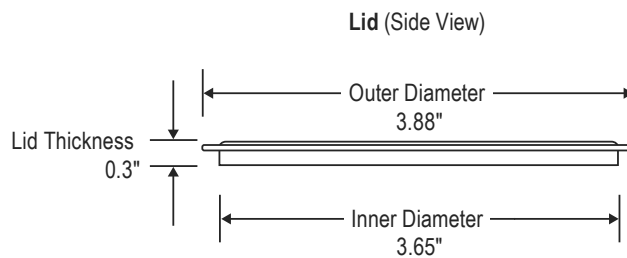
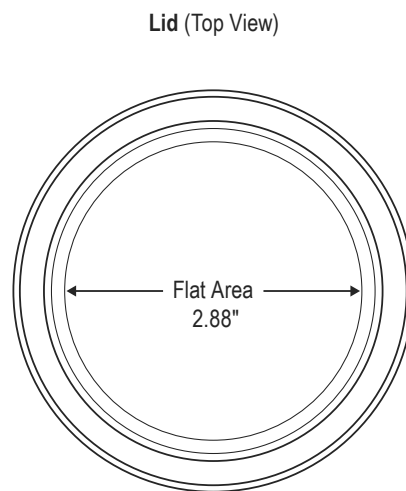
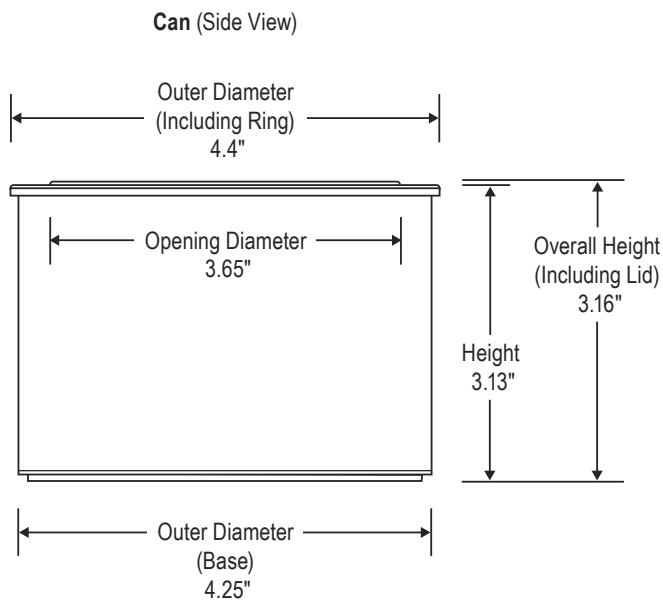

SPECIFICATIONS

	MATERIAL	SIZE	COLOR	CAPACITY	WEIGHT	THICKNESS	RECYCLABLE
Can	Recycled Polypropylene	1 Pint	Black	0.5 Liter	57 g	-----	#5PP

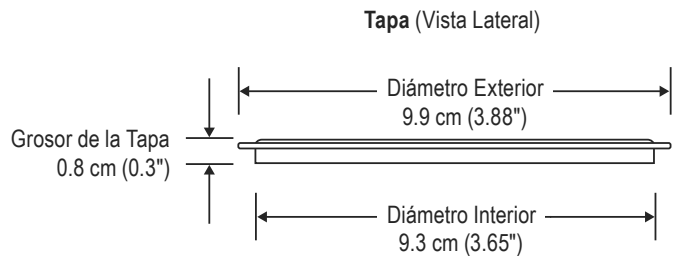
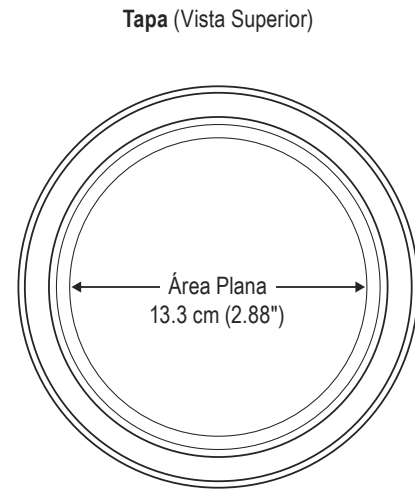
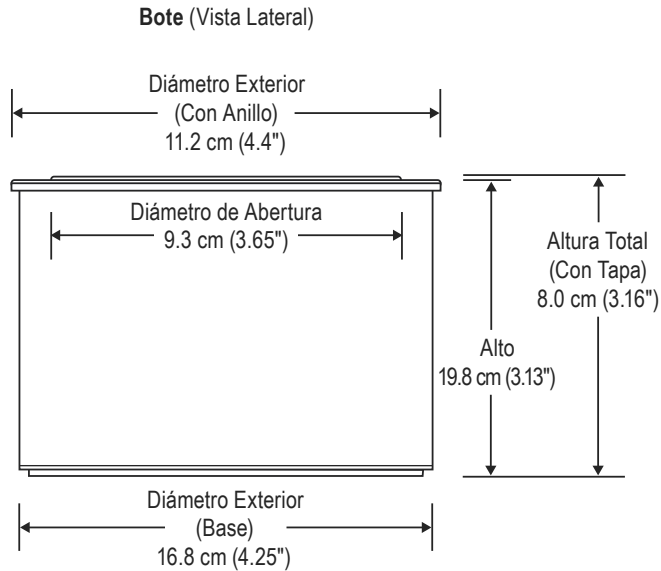
**ESPECIFICACIONES**

	MATERIAL	TAMAÑO	COLOR	CAPACIDAD	PESO	GROSOR	RECICLABLE
Bote	Polipropileno Reciclado	1 Pinta	Negro	0.5 Litros	57g	-----	#5PP

ULINE S-25171

**POT DE PEINTURE EN PLASTIQUE
AVEC COUVERCLE – 1 CHOPINE**

1-800-295-5510

uline.ca

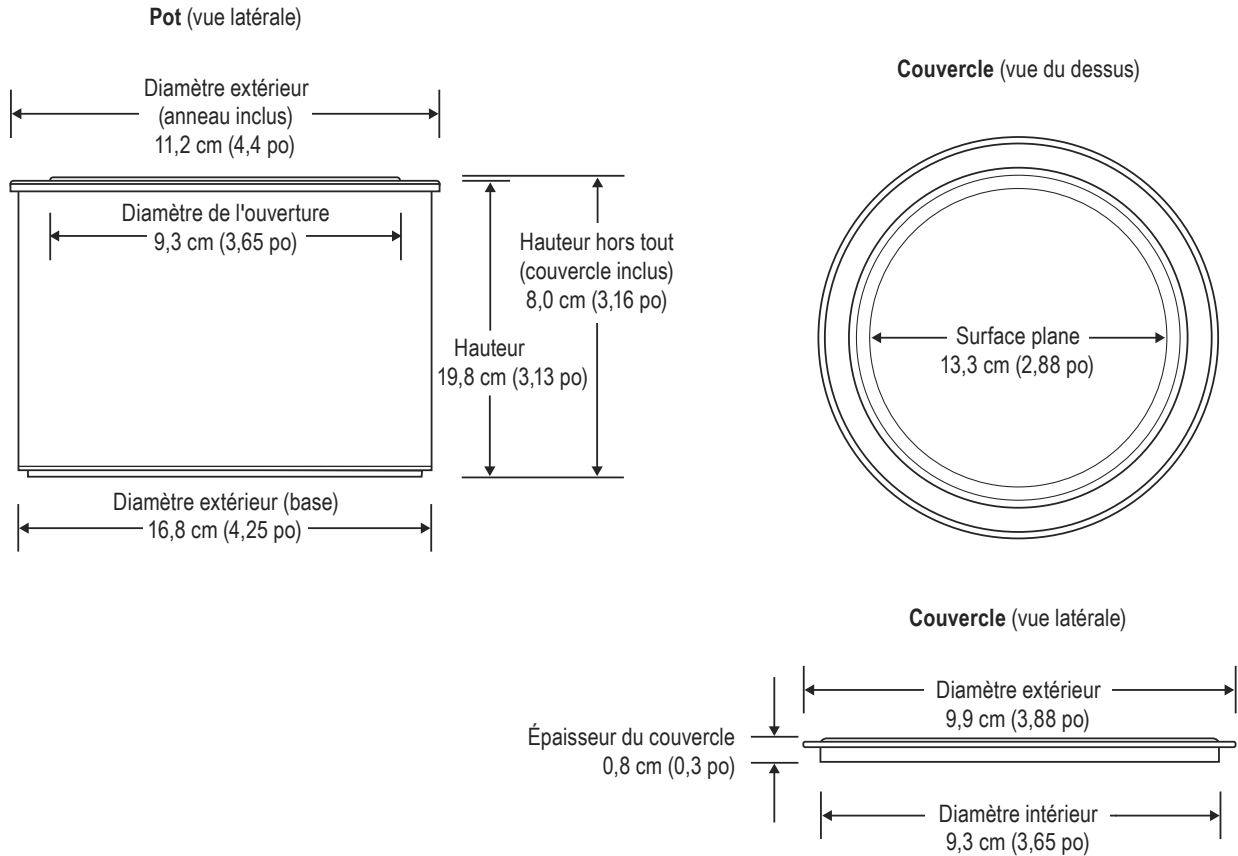

CARACTÉRISTIQUES

	MATÉRIAU	FORMAT	COULEUR	CAPACITÉ	POIDS	ÉPAISSEUR	RECYCLABLE
Pot	Polypropylène recyclé	1 chopine	Noir	0,5 litre	57 g	-----	n° 5 PP